

MAKE | BUILD | HACK | CREATE

# HackSpace

TECHNOLOGY IN YOUR HANDS

hsmag.cc

January 2022

Issue #50

**VINYL  
CUTTING**

Customise your mug



**RP2040**

The best dev boards tested



# MACHINE LEARNING

Improve your builds with  
artificial intelligence



**LIGHT  
PAINTING**

Take photography  
to the next level



**DIY  
CHRISTMAS  
LIGHTS**

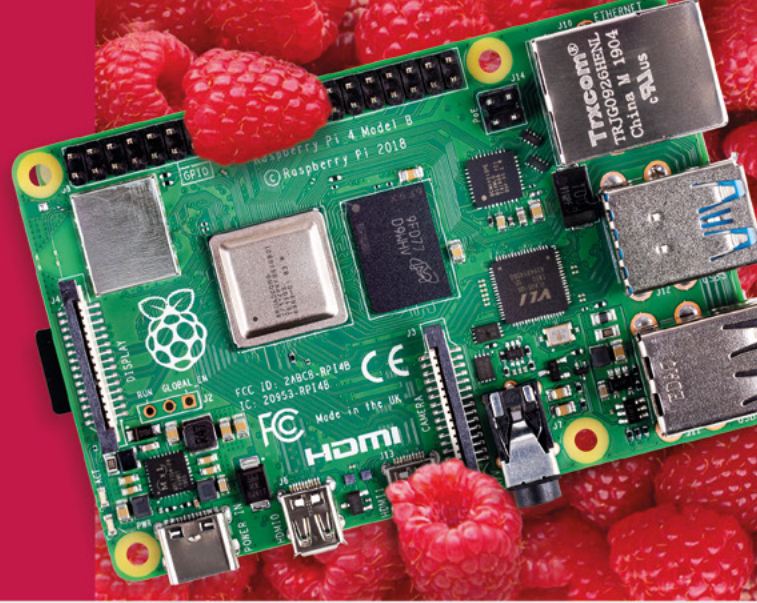
Control lots of LEDs  
this festive season

Jan. 2022  
Issue #50 £6



**WRAPPING 3D PRINTING PYTHON LATHES**

# American Raspberry Pi Shop



- Displays
- Cases
- Project Kits
- Add-on Boards
- HATs
- Arcade
- Cameras
- Cables and Connectors
- Sensors
- Swag
- Power Options
- GPIO and Prototyping

Partner and official reseller for top Pi brands:



and many  
others!

Price, service, design,  
and logistics support for  
**VOLUME PROJECTS**

USA

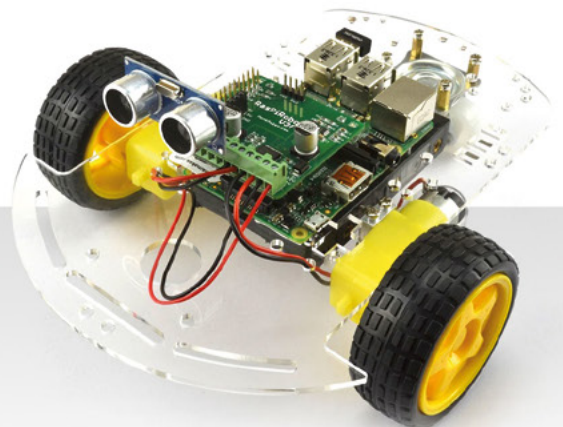


**PiShop.us**

Canada



**PiShop.ca**



**Raspberry Pi**

APPROVED RESELLER



# Welcome to HackSpace magazine

You might be familiar with the Gartner Hype Cycle. The basic idea is that when technologies are young, they get a lot of media attention, but they're not yet mature enough to be actually useful. This inevitably leads to disappointment as the wild claims made about the technology don't miraculously come true quickly. However, after the media attention has died down, the technology quietly matures without much fanfare. As time goes on, it gradually becomes more and more useful, and this time, excitement grows with actual usefulness.

It's this latter stage that machine learning is now in. Ten years ago, it was all hype and of little practical use. Now, the tools and techniques have moved on to the point where it's possible for a moderately technical person, with a bit of programming skill, to make a useful project using machine learning. It's not about to solve all the world's problems (as some of its more vocal proponents used to claim), but it can be a great tool for analysing data about the real world. In this issue, we're taking a look at some of our favourite projects that show off different aspects of machine learning. Flip to page 32 to find out more.

## BEN EVERARD

Editor [ben.everard@raspberrypi.com](mailto:ben.everard@raspberrypi.com)

Got a comment, question, or thought about HackSpace magazine?

get in touch at [hsmag.cc/hello](https://hsmag.cc/hello)

### GET IN TOUCH

[hackspace@raspberrypi.com](mailto:hackspace@raspberrypi.com)

[hackspacemag](#)

[hackspacemag](#)

### ONLINE

[hsmag.cc](https://hsmag.cc)



PAGE **44**  
**FREE PICO**  
WHEN YOU  
SUBSCRIBE

## EDITORIAL

### Editor

Ben Everard

[ben.everard@raspberrypi.com](mailto:ben.everard@raspberrypi.com)

### Features Editor

Andrew Gregory

[andrew.gregory@raspberrypi.com](mailto:andrew.gregory@raspberrypi.com)

### Sub-Editors

David Higgs, Nicola King

## DESIGN

### Critical Media

[criticalmedia.co.uk](https://criticalmedia.co.uk)

### Head of Design

Lee Allen

### Designers

Sam Ribbits, Olivia Mitchell, Ty Logan

### Photography

Brian O'Halloran

## CONTRIBUTORS

Jo Hinchliffe, Marc de Vinck, Rob Miles, Andrew Lewis, Rosie Hattersley, Nicola King, Phil King, Didier Briand

## PUBLISHING

### Publishing Director

Russell Barnes

[russell@raspberrypi.com](mailto:russell@raspberrypi.com)

### Advertising

Charlie Milligan

[charlotte.milligan@raspberrypi.com](mailto:charlotte.milligan@raspberrypi.com)

## DISTRIBUTION

Seymour Distribution Ltd  
2 East Poultry Ave,  
London EC1A 9PT

+44 (0)207 429 4000

## SUBSCRIPTIONS

Unit 6, The Enterprise Centre,  
Kelvin Lane, Manor Royal,  
Crawley, West Sussex, RH10 9PE

### To subscribe

01293 312189

[hsmag.cc/subscribe](https://hsmag.cc/subscribe)

### Subscription queries

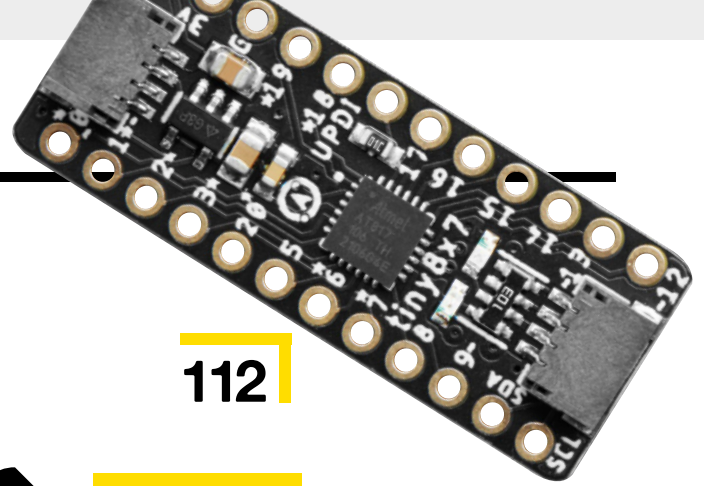
[hackspace@subscriptionhelpline.co.uk](mailto:hackspace@subscriptionhelpline.co.uk)



This magazine is printed on paper sourced from sustainable forests. The printer operates an environmental management system which has been assessed as conforming to ISO 14001.

HackSpace magazine is published by Raspberry Pi (Trading) Ltd., Maurice Wilkes Building, St. John's Innovation Park, Cowley Road, Cambridge, CB4 0DS. The publisher, editor, and contributors accept no responsibility in respect of any omissions or errors relating to goods, products or services referred to or advertised. Except where otherwise noted, content in this magazine is licensed under a Creative Commons Attribution-NonCommercial-ShareAlike 3.0 Unported (CC BY-NC-SA 3.0). ISSN: 2515-5148.

# Contents



112

06

## SPARK

- 06 Top Projects**  
Beautiful, functional builds made by real people
- 18 Objet 3d'art**  
Bring light to the dark months of winter
- 20 Meet the Maker: Lewis Aburrow**  
Learning and sharing with DIY Machines
- 26 Letters**  
3D printing: overhyped or just really useful?
- 28 Crowdfunding now**  
Light up your letters

31

## LENS

- 32 Machine learning**  
Teach machines to think for themselves. What could go wrong?
- 46 How I Made: Pilightpaint**  
Light painting in high-definition
- 52 Interview: Matt Stultz**  
Meet the Head of Community at Prusa Printers
- 60 Improviser's Toolbox** Wrapping paper  
Things to make and do with excess paper

## Cover Feature

# MACHINE LEARNING

Add brains to your builds with artificial intelligence

32

## Tutorial

### Vinyl cutting



94

Customise T-shirts, mugs, and almost anything else, with a Cricut

60



74



06



**Direct from Shenzhen**

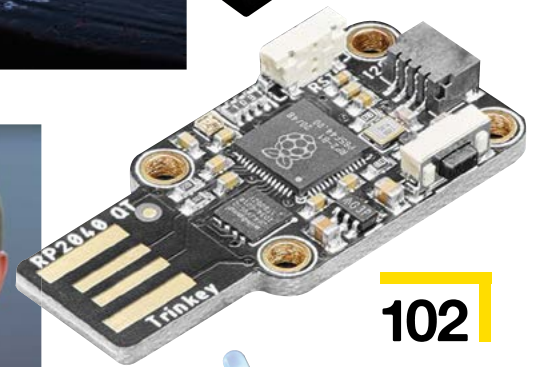
**Heat gun**



46

**Meet the Maker**

**Lewis Aburrow**



102

108

Solder tricky components with the power of hot air

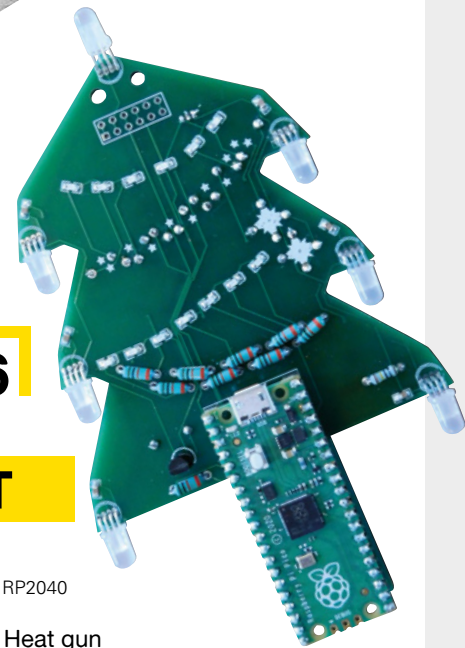
73

**FORGE**

20

On the unexpected loveliness of the maker community

66



- 74 **SoM Pico gearbox**  
Resurrect a broken lathe with a Raspberry Pi Pico
- 80 **Tutorial Parallel NeoPixels**  
Power 26 chains of NeoPixels in one go
- 82 **Tutorial Sensors**  
Detect gases with a Raspberry Pi
- 86 **Tutorial FreeCAD**  
Design for building with folded metal
- 94 **Tutorial Vinyl cutting**  
Clean, automatic designs with Cricut
- 98 **Tutorial Festive lights**  
Custom blinkenlights for your Christmas tree

101

**FIELD TEST**

- 102 **Best of Breed**  
The best development boards for RP2040
- 108 **Direct from Shenzhen Heat gun**  
A budget solution for surface-mount soldering
- 112 **Review Seesaw**  
Add extra features to your microcontroller

Some of the tools and techniques shown in HackSpace Magazine are dangerous unless used with skill, experience and appropriate personal protection equipment. While we attempt to guide the reader, ultimately you are responsible for your own safety and understanding the limits of yourself and your equipment. HackSpace Magazine is intended for an adult audience and some projects may be dangerous for children. Raspberry Pi (Trading) Ltd does not accept responsibility for any injuries, damage to equipment, or costs incurred from projects, tutorials or suggestions in HackSpace Magazine. Laws and regulations covering many of the topics in HackSpace Magazine are different between countries, and are always subject to change. You are responsible for understanding the requirements in your jurisdiction and ensuring that you comply with them. Some manufacturers place limits on the use of their hardware which some projects or suggestions in HackSpace Magazine may go beyond. It is your responsibility to understand the manufacturer's limits.

# Marblevator

By Greg Zumwalt

[hsmag.cc/Marblevator](https://hsmag.cc/Marblevator)

# W

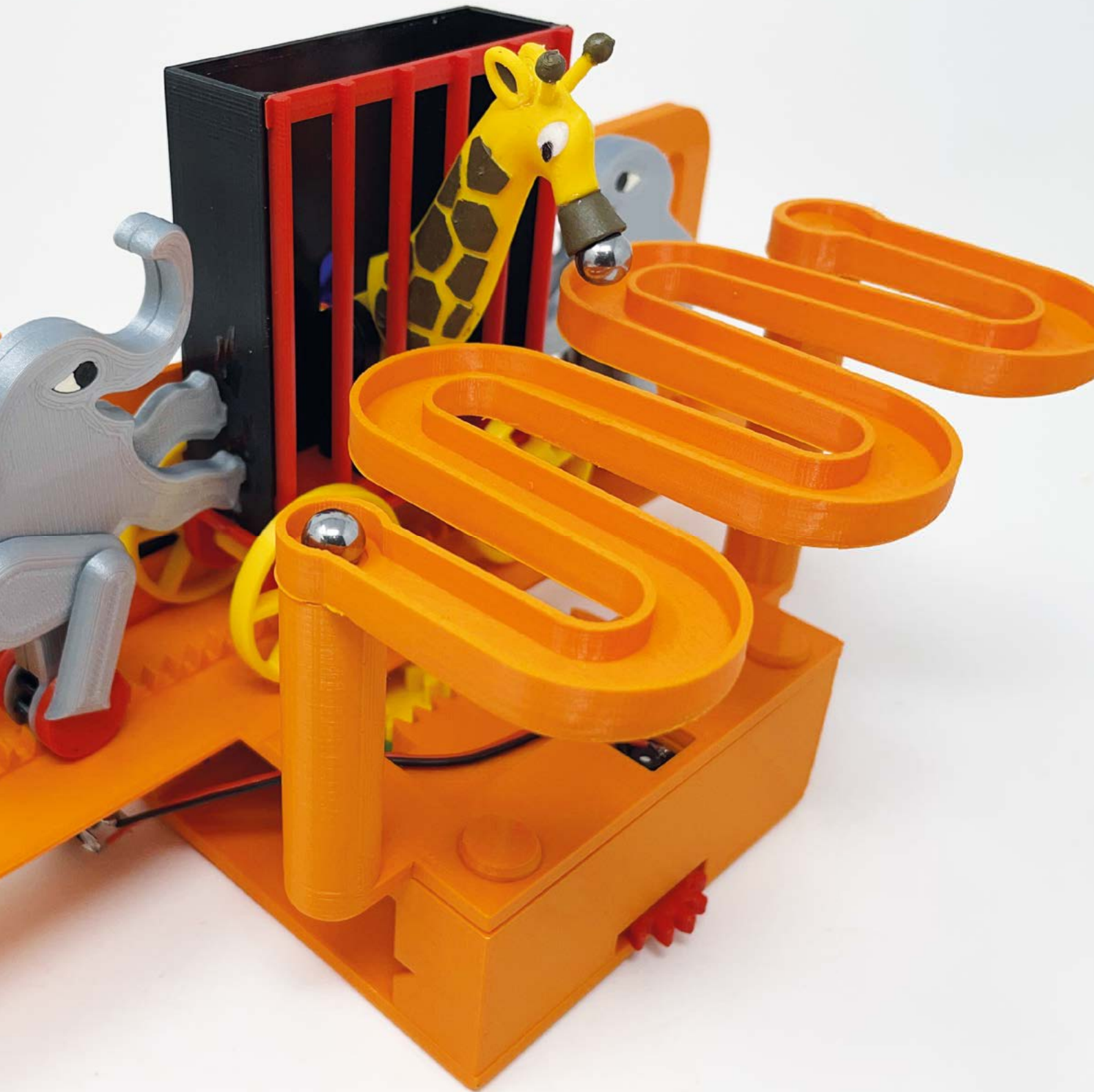
**e love simplicity, but we also love the whirr and click of moving parts working exactly as they should.** That's why this build by Greg Zumwalt stands out: it's just so precise.

This circus-themed marble run comprises 50 unique 3D-printed parts, many of which fit into confined spaces, needing very precise alignment. Because of that, Greg used the Engineering Profile in Ultimaker Cura to slice his models, and did a dry run before he glued anything together.

Mechanical parts include a motor, power supply, 32 3×1.5 mm neodymium magnets, two 6×1.5 mm magnets, and two 8 mm ball bearings. Greg's made all the design files available, so if you feel like a challenge, have a go yourself! ▣



**Right** ▣  
Missing your ball bearings? Watch out for giraffes, notorious thief of round metal



# Moon Phase Clock

By James Mabon

[hsmag.cc/MoonPhaseClock](https://hsmag.cc/MoonPhaseClock)

**J**ames Mabon wanted a project for his new 3D printer, and to give himself an excuse to learn Fusion 360. So here's what he created: a clock that, as well as telling the time, shows you the phase of the moon. This wasn't just a 3D printing challenge: astrophysics is notoriously difficult, and James made a few simplifications to the mathematical model he used, ignoring the way the moon wobbles on its axis, as well as a couple of other things. Nevertheless, the gear train he's used to show the constantly shifting phases of the moon is astonishingly accurate, having a deviation of less than one minute in 25 years. □



**Right** □  
The 3D-printed model of the moon was already provided (it's on Thingiverse here: [hsmag.cc/NASAMoonKit](https://hsmag.cc/NASAMoonKit))





# Tiny Mac

By C Genco

[hsmag.cc/MicroMac](https://hsmag.cc/MicroMac)

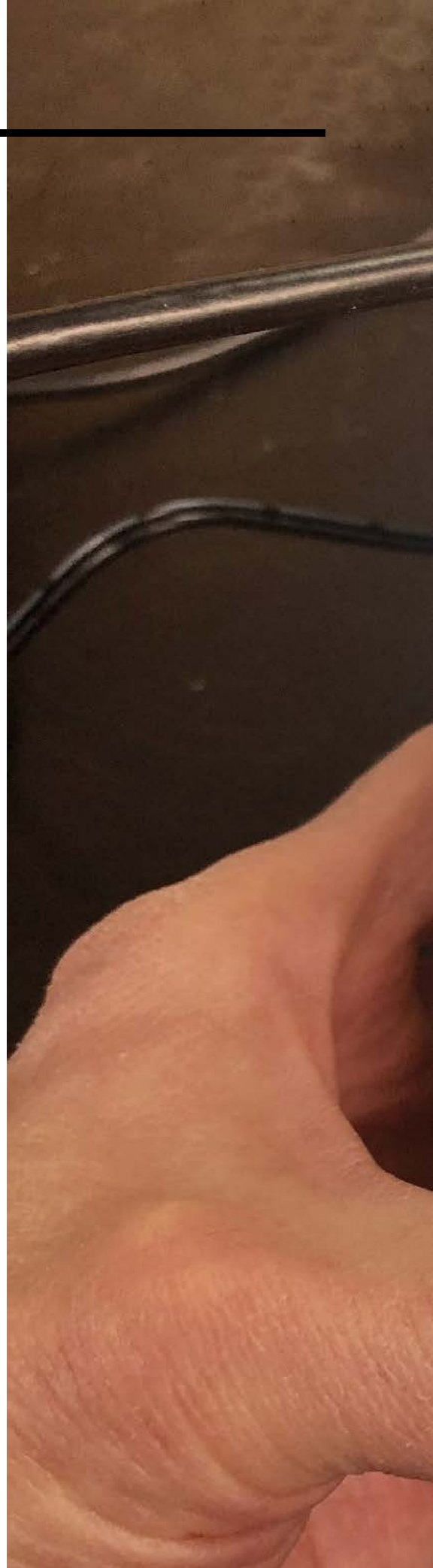
**C**alifornian computer company Apple now houses its machines in machined aluminium, but there was a time when, like all other computer makers, they housed their wares in a rich shade of beige.

If you miss those primitive days, you can now print your own very small Macintosh computer on which you can play Lemmings, surf the web, and do whatever else you can do on a Raspberry Pi Zero W.

You'll need – no surprise here – a Raspberry Pi Zero W, plus the headers to attach to the GPIO pins, a power supply, and a mini HDMI to HDMI cable (for setup). The most important component however is the screen: this design uses a 640×480 LCD display; if you can't find one of these, or if the screen you use is a slightly different size or shape, you'll have to tweak the design of the case. Thankfully, you can, as the maker has shared all the files. □

**Right** □

C Genco has created two versions of this design: one with the SD card slot on the side, and one with it on the front, where the disk drive went on the original machine





# Fibonacci Spiral Clock

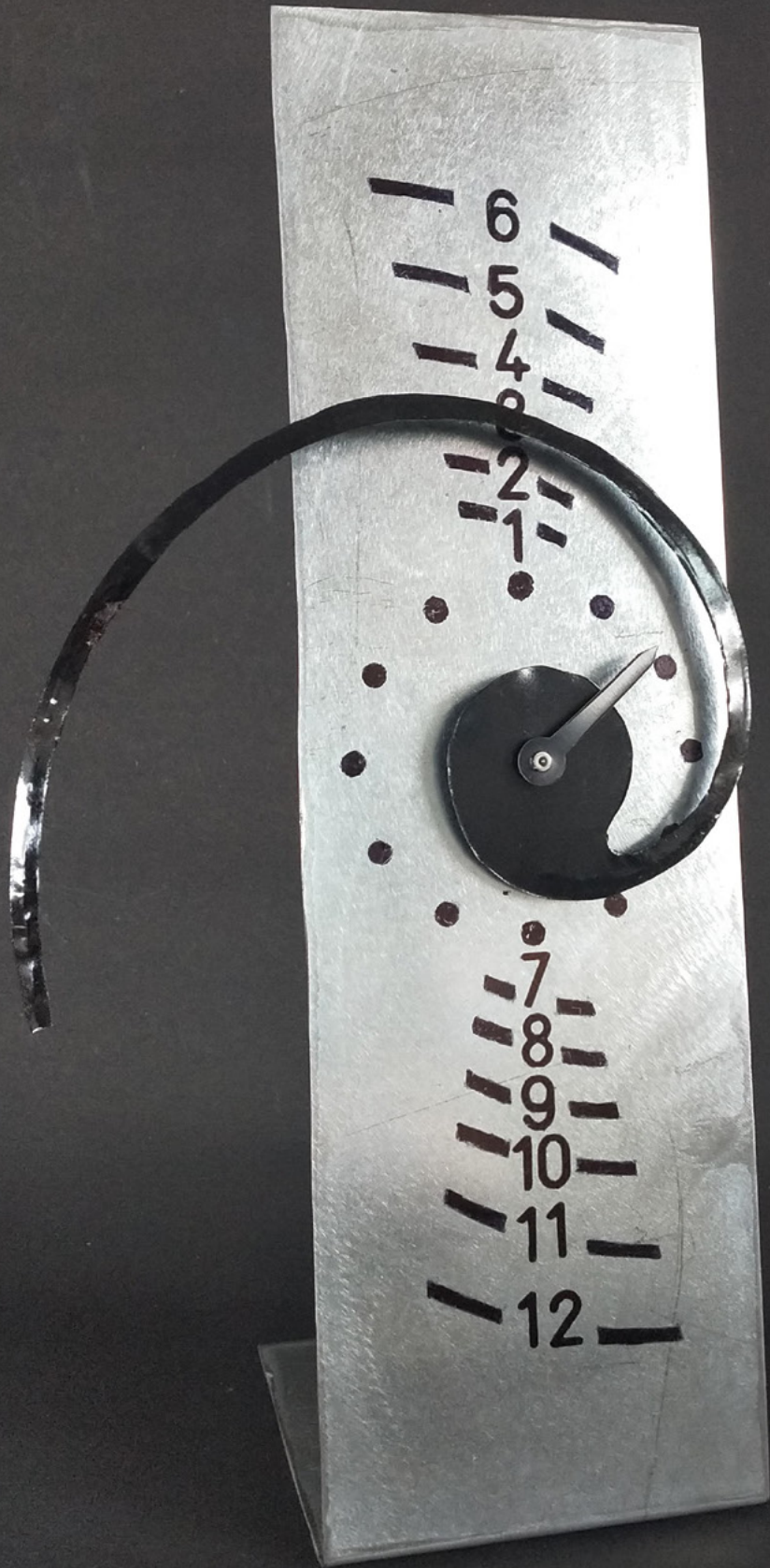
By Bushra Juwairia Mulla

[hsmag.cc/FibonacciClock](https://hsmag.cc/FibonacciClock)

**S**ome of the builds we see are fiendishly complicated, full of moving parts, CAD, and advanced techniques that we promise ourselves we're going to learn about one day. Some builds, in contrast, are so beautifully, brilliantly simple that we know we could replicate them right away, but there's no point, as the original is perfect. This clock, inspired by the Fibonacci series of numbers, is one such example of simple perfection.

Bushra's creation uses the guts of a standard wall clock, which he's mounted to a single piece of stainless steel, bent so it'll stand up. He's kept the minute hand, but the hour hand has been replaced by a spiral modelled after the Fibonacci curve, which tells the time as it turns by overlapping markers placed on the steel. □

**Right** □  
A true Fibonacci curve never touches in the centre; this version has been modified so it can exist in the real world



# Quantum Death Machine

By Gocivici

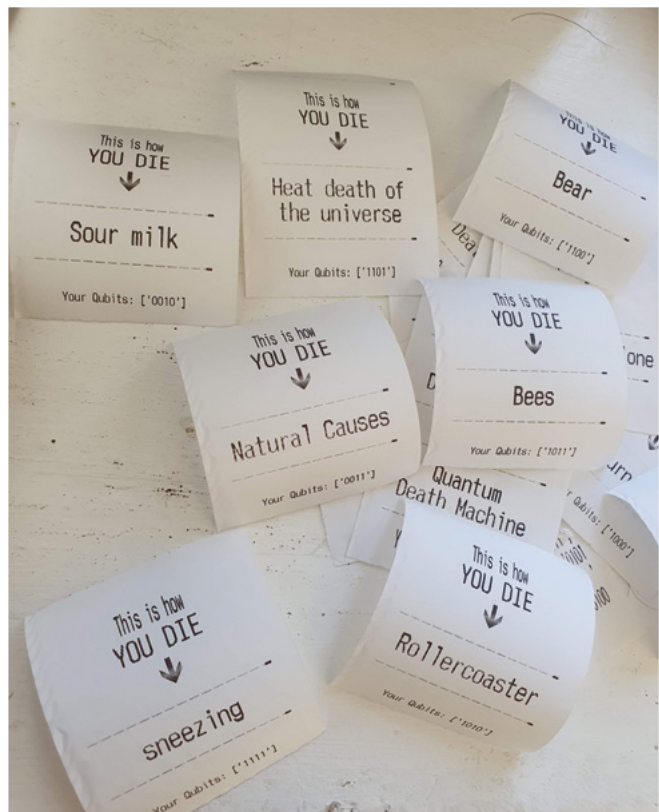
[hsmag.cc/QuantumDeathMachine](https://hsmag.cc/QuantumDeathMachine)

**If you had a background in quantum physics, what would you build?** A time machine? A teleporter? Or, a box that detects the presence of a human, then tells them how they're going to die (based on utterly nothing)?

Maker Gocivici decided to do the latter, and here it is: the Quantum Death Machine. It's an audacious exercise in over-engineering, using IBM Quantum – an online quantum computer that can provide truly random data (randomness is something that computers struggle with on their own).

It also uses a Raspberry Pi 3, an Adafruit thermal printer, an Arduino Nano, and a fingerprint sensor.

In use, the clever quantum computing is hidden away: the user sticks a finger into the opening where the sensor is mounted, the machine registers that you're there, then it gives you a prediction of how you'll meet your end. That's it. It doesn't ask if you smoke, drink too much, drive without a seatbelt on, or any of that; it just uses the randomness of quantum computing to print you a response from a pre-populated list of deaths. ▣



**Right** ▣ Death by “Bees” is something we’re keen to avoid



# Darrieus Wind Turbine

By Adrian Cubas

[hsmag.cc/DarrieusWindTurbine](https://hsmag.cc/DarrieusWindTurbine)

**T**his isn't the first, or the most complicated wind-powered generator we've featured in HackSpace magazine – that honour falls to WinDIY, the completely 3D-printed, beautifully engineered creation by Fabian Scherschel. This creation, by Adrian Cubas, is very different, but it shares some similarities. First of all, it's a vertical axis turbine, meaning that the user doesn't have to constantly adjust its position so that it's facing the wind. Secondly, it's 3D-printed, and it's also a great educational tool.

The difference is mainly in the simplicity – instead of extruded aluminium, steel rods or the like, this model used only 3D-printed parts and something that every teacher should have plenty of: pencils. □

**Right** □  
The Darrieus wind turbine is named after its inventor, French engineer Georges Darrieus

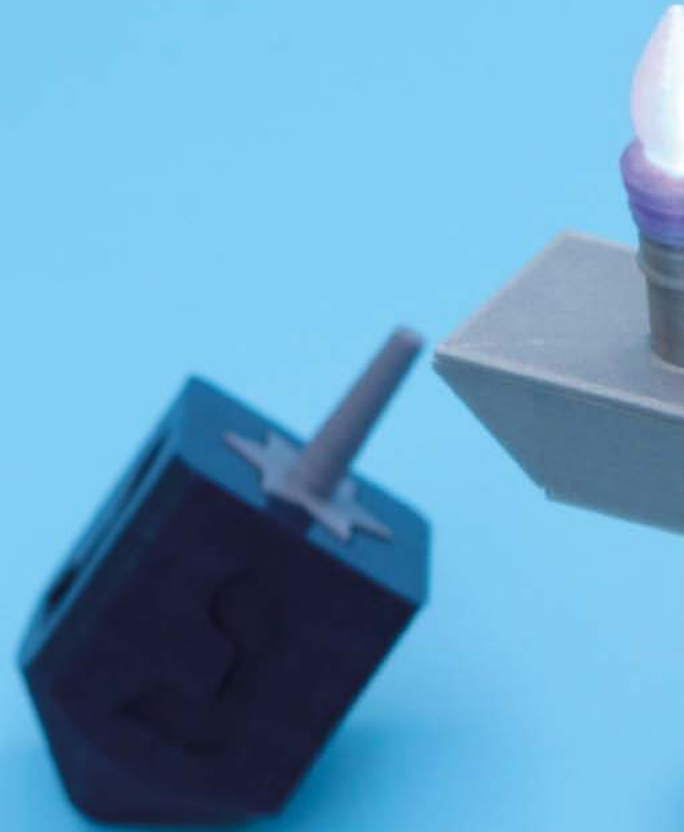






# Objet 3d'art

3D-printed artwork to bring more beauty into your life



**T**he menorah is used to mark the days of the Jewish festival of Hanukkah; to mark each day of Hanukkah, you'd normally light a candle each day. This

interpretation by the Ruiz Brothers uses NeoPixels instead of candles, in a simple 3D-printed frame, which prints with no need for supports, thanks to its clean design. Even the bulbs are 3D-printed – in this case in translucent PLA to diffuse the light.

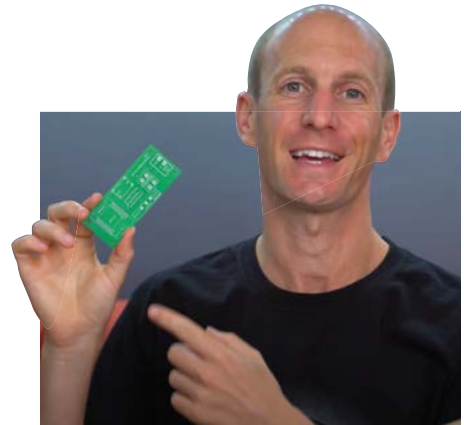
Intelligence is provided by an Adafruit QT Py RP2040, which takes in power through a USB-C socket at the back of the menorah, and spits out CircuitPython logic to light one additional bulb per button press. □

➔ [hsmag.cc/Menorah](https://hsmag.cc/Menorah) □



# Meet The Maker: Lewis Aburrow

Keep learning, even when things go wrong



**S**elf-taught, masterful command of 3D printing, CAD, electronics. There's something refreshingly old-fashioned about Lewis's material, which he shares at [diymachines.co.uk](http://diymachines.co.uk). He's not trying to constantly release new content to grab the attention; his builds are ready when they're ready. Much more than that, they're a resource for learning from. We spoke to Lewis to find out why it's so important to him to make learning accessible, what keeps him going when things are going wrong, and why he'll never leave electronics unattended again.

"I got kind of frustrated with those, because I thought if I'm gonna buy the parts for this video, I want to make sure it's going to work and that everything they did is documented; they've not skimmed through it to make it look elegant and easy. So that's why I tried to document my builds really well, because if someone is going to spend their pocket money on buying the parts to build it, I want to make sure they're going to be successful. It seems only fair.

"I have a twin brother, and though we live in the same town, as life goes, we don't really see as much of each other as we probably should. So we decided to build a bar robot as a project we could make together. We started working on it, and then life got in the way for him. He got married, they bought a new house as well. So he couldn't show up. And I was starting to get addicted, because I had heard of Arduinos and things like this. The idea of programming something that could do something in the real world was really scary. I thought that that was the stuff of universities.

"And then you see a few lines of code can blink an LED or turn a motor left or right. So, I kind of got really addicted to this. I'd done a bit of amateur web design, but that's code on a computer – code that could interact with the real world was amazing. I finished the project on my own, my friends liked it, and that's kind of how it started.

"Like a lot of makers, I love technology, and I was looking for a new hobby. So I backed the Buccaneer

**//** Someone in Australia could invent something today, and I can have it on my printer in a matter of hours – here, physically in my house **//**

"When I started making things, I knew nothing about making. I didn't have any education in electronics or design or coding or anything like that, so I could only learn from looking at other people's projects.

"I'd sit and watch them and then suddenly go from one cut to another; there was one I remember watching where the person glued something together and in the next cut there was a screw, so I could see that gluing alone wasn't good enough... it felt like a lie.



on Kickstarter by Pirate3D – a controversial one because they went bankrupt before they fulfilled all the orders. I was one of the very few percent who actually got a printer.

“Luckily, though, that sparked an interest in 3D printing. At the time, I was building a model railroad, printing elements and things like this. And I outgrew it quite quickly, because the company wasn’t around, there wasn’t a lot of support. So I saved up my pennies, bought myself a Prusa, and that’s how that addiction started.

“At the moment I’m working on a weather bot. It’s a machine which goes to the Internet of Things OpenWeather service to retrieve the forecast for today and tomorrow. It uses a series of four discs to represent wind, rain, cloud cover, and... another one. And once it’s got that data, it rotates the discs, creating a diorama that illustrates the weather. To build this one, I had to learn internet APIs – that took me a while. I’ve never fetched data on the internet and stored it as a JSON object before. And talking to an e-ink display – that’s new to me. One day, there’ll be a project where when I start it, I’m like, I can see where I’m going. But so far, I mean, it’s great to learn stuff. It’s what keeps me interested.

“I’m going to keep it all 3D-printable, I am quite 3D-printed orientated. And I don’t want to ever

publish something which uses a tool that’s prohibitive to a lot of people. So the discs will be 3D-printable, like these plastic ones. But I’ll also upload wooden ones, for people who might have access to a laser.

“I had some problems trying to figure out the orientation of the discs but I think, as of last night, I found a way to figure out where they are when it powers up.

“I’ve been printing for about five years. I still find it amazing that I can draw something on the computer, click a button, print overnight, and in the morning I can have a physical copy of what was on the screen the night before. To be able to do that, in your own home is insane. It’s amazing. Someone in Australia could invent something today, and I can have it on my printer in a matter of hours – here, physically in my house. It’s incredible. →

**Above** ♦  
The machine that started it all: the Bar Bot, maker of automated cocktails





### SHARING IDEAS

“I always give everything I make away for free. All the plans, the 3D-printed models, the programming, the code, everything so that everyone can make it. I think it’s unfair to put it behind a paywall. But then what I’ll do is, I’ll create an additional something so that if you want to enhance the project, you can make a donation. In my most recent build, I used triangular panels in that design. So I created a square one – I just pop that on my Etsy shop for £3. And it’s a way of saying, ‘If you’ve enjoyed it, you could kind of donate to the cause. But I’ll also be able to give you back something as well, to say thank you for the donation.’”

“That helps out a lot. So with each project, I’ve done that. With the weather bot, for example, the scenery that you saw was a cityscape. But I’ll create a second set of discs, which might be countryside, or beach-

themed scenery that changes, and they can have that for a donation. But I will give away blank discs, explaining where to put what, so people can design their own weather dioramas. So, if you want to make it for family members, you might put in their dogs, family, or something – [that] would be kind of cool.

“What has really taken me by surprise is that I had a few people suggest I started a Discord server, so I did. I thought I would run it for like a month or two, and then it would just kind of shut it down because there wouldn’t be anyone there. But no, it’s really lively. There are so many engaged people – lots of people who are currently making a project, or have made it, and are still hanging around to help other people out.

“With the Sisyphus table, for example, people are taking the mechanisms and rearranging it or changing it to create different tables. I’ve seen an absolutely stunning circular version using the same mechanism. There’s another chap who’s building a vertical version into his wall so that it can move things around from behind the wall. He’s into horror films. So he likes the idea of things on his wall just moving around.

“It’s amazing. If I could spend a year on each project, I would, because I always want to polish this, or I want to revisit that. So I get them so far, then part of me says ‘Nope, you got to film it, document it, and share it’. So then, when you see other people take it further, I’m kind of like, ‘Oh, good, they’ve made those improvements, or they’ve revised the



**Right** ♦  
Lewis provides the design files for everything he does, so if you build the weatherbot, you can include your house/dog/loved ones in the design



code'. And I really enjoy seeing it. And sometimes in ways that you didn't think about, which is even more amazing.

"The shelf clock video was over a year ago now. Someone rewrote the code for that, and it was so good that I ripped the internals out of mine here – the original one – and put their code and wiring design into mine. And I absolutely love it. It's brilliant. She's called Florian; I'm going to do a video showing everyone what she's done to it as a follow-up video to my original build. And if it wasn't open-source, none of this would be happening.

Everyone stands on the shoulders of giants, no matter how big the giant is. We're all just helping each other up.

"I picked this phrase up from another YouTuber once, I can't remember who it was. But they said that you should fail fast and fail cheap. Because so many times you're worried about starting something because it's gonna be wrong, or might cost you a lot. But if you tell yourself, it's OK to make a mistake, to burn out your Arduino Uno when you connect the power to the ground lead or something, and be prepared to fail. That's OK.

"I've got a pile of parts here for this weather bot. Some of them are small mistakes, some are big mistakes, but I could have modelled it in Fusion 360, forever trying to polish out every little bit. But the moment I start printing, that's when things really start happening – because you can see it, you assemble

it, and then you realise 'Oh, actually, I can't reach that screw'. So don't be afraid to fail; fail fast and fail cheaply.

"The Arduino Uno that sparked my interest in these kinds of electromechanical builds – if it had cost even £50, I'd be like, 'I don't wanna break that. It's too

dangerous for me to play with that'. But the prices I could get them at encouraged me to have a go, and then you get the Chinese versions, and I've gone through a few now. I had a couple of small fires, and then I got the textbooks out, and I learned about why

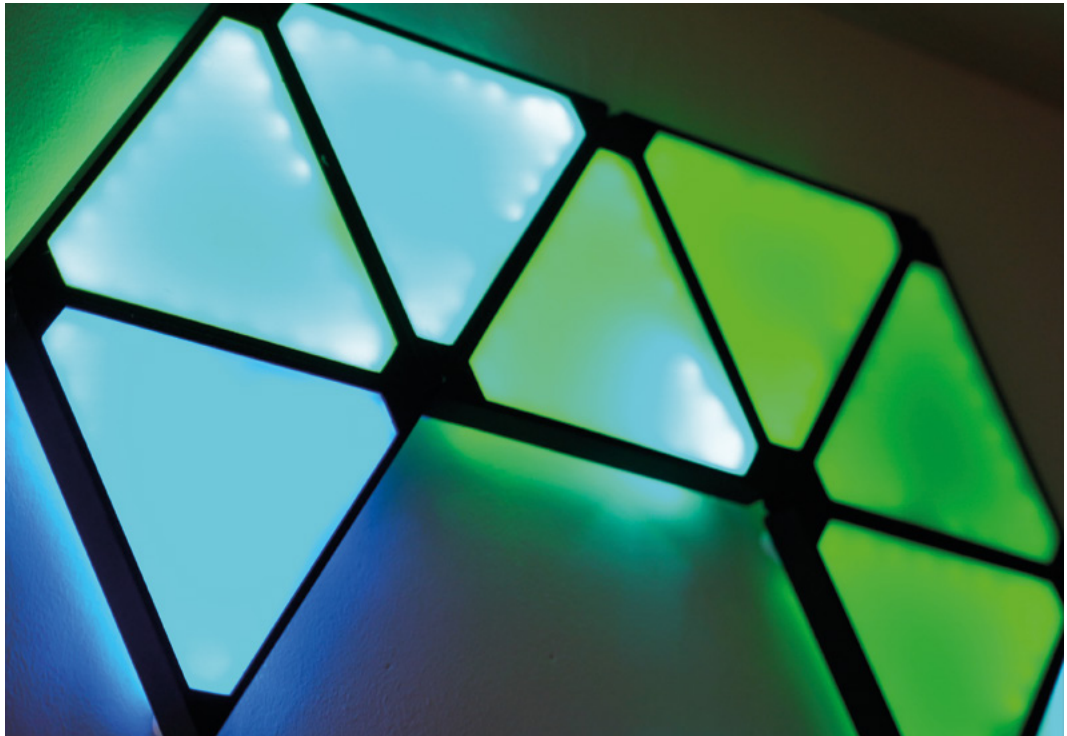
it went wrong and how to avoid it in the future. And that's what I'm learning. →

“ **Everyone stands on the shoulders of giants, no matter how big the giant is** ”

**Above** Take the drudgery out of laying dominoes with Lewis' machine

**Below** We've seen these kinetic sand drawing tables before, but never attempted to build one



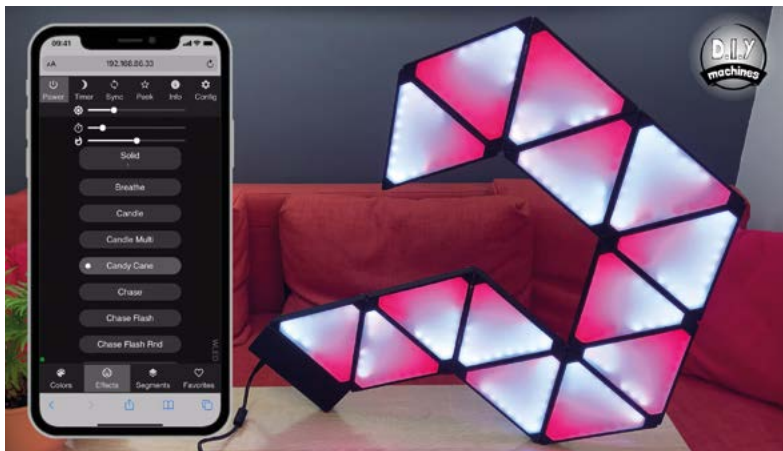


"I'd incorrectly estimated how much power the LEDs on a project would use; I had a beefy power supply. But, in the chain of power wiring, I'd bought some little screw adapters so you get the wires from the power supply. One of those melted because there was too much current going through it. I was a bit annoyed, because I bought it with a 10 amp power supply - 12 volt, 10 amp power, a super-beefy one. But it turns out, when I went to look up this particular connector, it was only rated for one and a half amps, so it was a bit of a dodgy kit. I did warn my Patreons what happened when I found out what went wrong. Be aware that if you buy these power bricks on Amazon with these little screw terminals - they're often not rated for as much as they should be.

"Luckily, I was only in the room next door and I could smell it and I came in, but I used to leave stuff testing overnight. I won't do that anymore!  
"Sometimes, I think it would be nice to know this stuff at the start of a project, to have the background knowledge. If I could go back and talk to younger Lewis, I'd tell me to go to university and study something in electrical mechanical engineering. You'll

**Above** ♦ Lewis's builds use precise 3D printed parts - such as this glowing geoleaf implementation

**I feel like I'm a bit late to the game, but I don't mind. I'm still having fun**



really enjoy yourself. And no, don't worry about a job afterwards. Just go in and, if you're going to be passionate about something, really immerse yourself in it. Don't jump halfway - just go for it and, like, become an absolute geek in it.

"And then you'll find something afterwards, just because if you're passionate, if you want to do something for yourself, you'll enjoy it.

"I feel like I'm a bit late to the game, but I don't mind. I'm still having fun.

"When I put the first video up, I didn't know what was going to happen. But people are really nice





**Above** ♦ This giant 7-segment display/shelf unit is a masterpiece of 3D print and electronics design

**Left** ♦ Resin printed chess piece – we think this one is called a horsey

online. When we did the first video, my brother and I were expecting 20% bad stuff in comments, of course, because the internet is a very open, free place, and people can be not so kind in their words. It's not been like that at all. 99.8% of comments are so kind or helpful or informative.

"The maker community seem very kind if you're not trying to pull a fast one on them.

"And though it seems social, the idea of working on YouTube or on social media – the truth is that you're at home. I'm in this little room on my own all day, talking to a camera, then you're editing, and you might answer some comments and things.

"So, it's not as social as it might seem. But something magical happened – people send in photographs. I've got a pinboard, just behind the camera up here, where I pin the photos they send of things that they've made.

"And they've written in with a picture – parents or grandparents who've worked with their children on a project. And they're like, 'We built this together, we're really grateful for having something we could do as a family because the children learn coding at school now. And we just wanted to let you know how much fun we had, and that we're about to start this project from you next.' And I didn't expect that. They

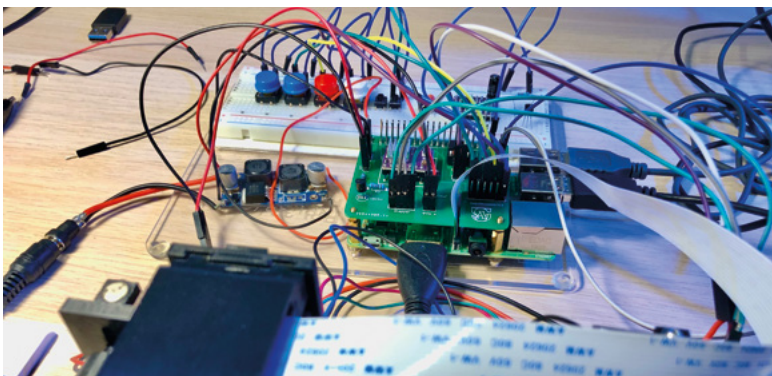
kept coming. So, I pin them up now because, when you're behind the camera and everything's going wrong, I just look at it and go, 'People are watching this and they're building.'

"I didn't expect any of this to happen. I'm quite surprised and amazed and really appreciative." □

# Letters

## ATTENTION ALL MAKERS!

If you have something you'd like to get off your chest (or even throw a word of praise in our direction) let us know at [hsmag.cc/hello](http://hsmag.cc/hello)



## FAREWELL SANJAY

As we went to press, we learned of the passing of Sanjay Mortimer. Sanjay had been heavily involved in the hobbyist 3D printing industry for as long as there's been a hobbyist 3D printing industry. As a co-founder of E3D, he helped create the hot ends that many of us use everyday.

Thank you Sanjay for helping make the 3D printing world a happier place. Our thoughts go out to all of his friends and family.

## FILM SCANNER

Well done to your writer [Anton Gutscher, *How I Made*, issue 49] who digitised a load of old film with a film scanner he made himself. For me, that's what open-source hardware is all about: finding a solution and fixing it with whatever you have to hand, because you can. I remember when 3D printing first hit the headlines about 15 years ago: we got all these stories about how we'll 3D-print jet packs and live in 3D-printed houses. The reality is more prosaic than that – we print what we need, when we need it – but it's also wonderful that so much human creativity has been unleashed. It's a brilliant time to learn to 3D print!

**Marcus**

New York

**Ben says:** Yes! It's unrealistic to expect everyone to be able to fabricate metal at home, or carve wood to any degree of accuracy. But, a small 3D printer is accessible to anyone with a bit of shelf-space. It's a quiet revolution.





## DOCUMENTATION

May I extend my congratulations to Anne Barela [Meet the Maker, issue 49], who, on retirement from a serious job, went into a fun job at Adafruit. I've bought components and boards from the likes of Adafruit, Pimoroni, and SparkFun, and I've bought knock-offs from China. The money I've saved on the unbranded products has almost always been far, far outweighed by the extra time I've spent getting them to work, searching the internet for instructions that don't work, wiring them up wrong, then having to buy new because I've got the voltage wrong. I don't waste my time now; it's just more efficient to buy stuff with proper documentation, so, thank you Anne for the work you do making CircuitPython projects just work.

**Lee**

Northampton

**Ben says:** Completely, 100% this. Time is, as they say, money. If you spend a couple of hours of frustration to save a few quid, is that a good trade-off?



## STEREO PHOTOGRAPHY

I had to laugh at the stereo photography tutorial you ran last issue. The lowest tech way of producing a stereo photograph that I can think of is to use two cameras mounted a couple of inches apart... and there it was on the page! All your fancy degrees, and the best you can come up with is the absolute basics!

**Michaál**

Belfast

**Ben says:** In all fairness, the simple solutions are very often the best ones. If mounting two cameras together makes a perfectly cromulent 3D photo, so be it. But as I recall, it didn't end there: there's all sorts of tricks you can pull with software, mirrors, and sliding brackets, so there's plenty to get your teeth into.

## ERRATA

There was a small error in the online version of issue 49, whereby the issue had most of the right pages, in mostly the right order. This has now been fixed, so if you downloaded it on day one and are baffled by the way we've reinterpreted page numbers, try it again now.



# CROWDFUNDING NOW

## Pixie Chroma

Light up your text in almost any colour

From \$45 | [hsmag.cc/pixie](https://hsmag.cc/pixie) | Delivery: March 2022

It's no secret that we're big fans of LEDs here at HackSpace mag. They shine brightly and are perhaps the most flexible user interface element. You can shine them through things, on things, or just admire their bright, clear colours.

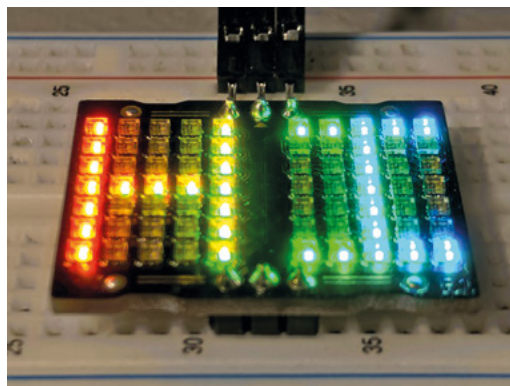
One of the very first uses for LEDs was the seven-segment display. This lets you display any number and a few letters using seven LEDs. There are a few adaptations on this style that add more segments – thus letting you display a wider range of characters – but it's remained fundamentally unchanged for decades. That is, until Lixie Labs came along.

The Pixie Chroma is the latest in a series of display modules that have brought character displays up to the 21st century. Each Pixie Chroma consists of a two-character display, and each of these is a 5x7 matrix of SK6805 (NeoPixel compatible) LEDs that can display a single character.

The real power behind this, though, isn't that there's a bunch of RGB LEDs; it's the software behind it. While we haven't tried it out, from the documentation, it allows you to display a string of

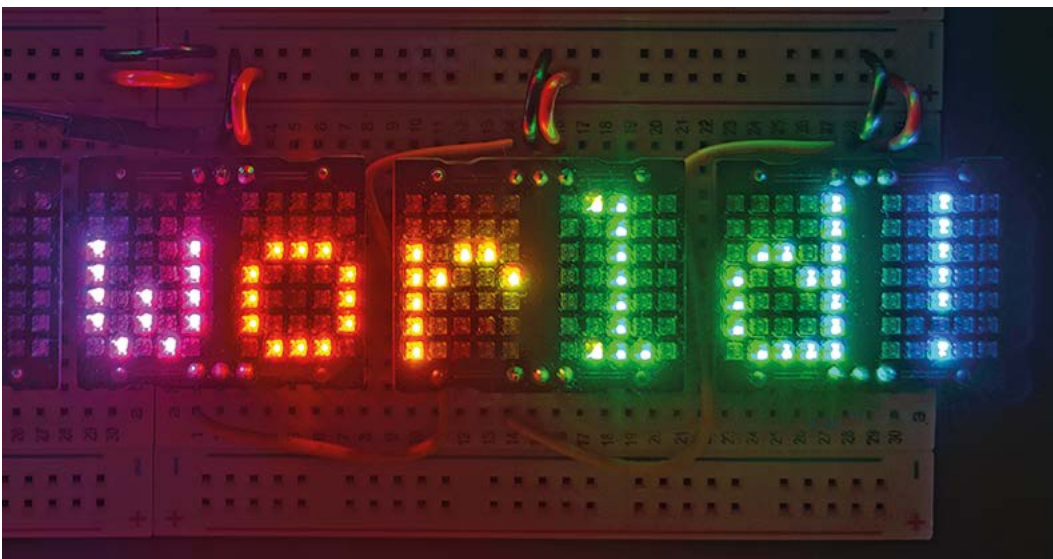
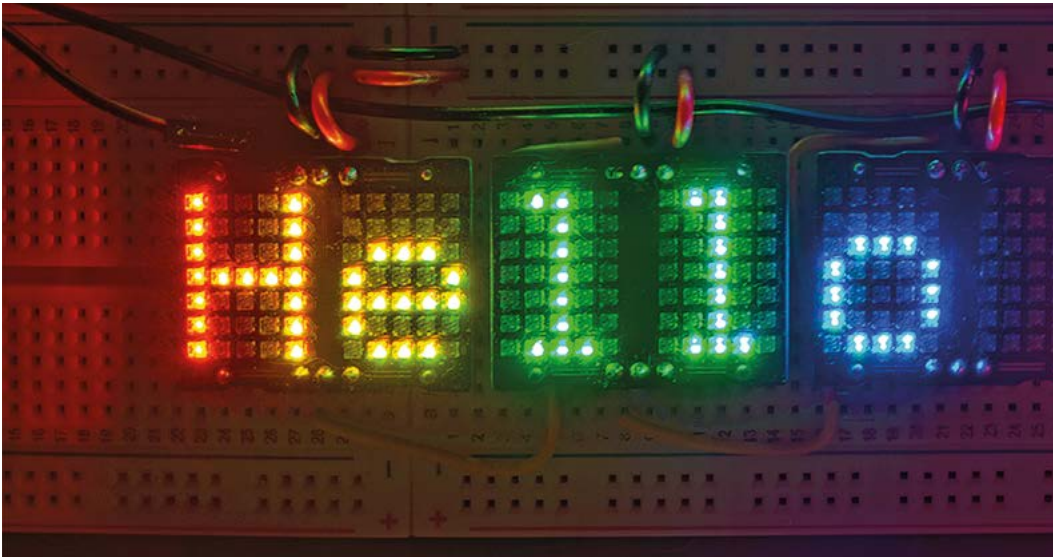
text as easy as using `serial.println()` (yes, it's an Arduino library). As well as letters and numbers, you can show pre-defined characters – basically anything that fits into the 5x7 matrix. As they're RGB LEDs, you can display them in a wide range of colours, too.


Prices start at \$45 for two Pixie Chromas (which can display four characters). While it isn't the cheapest display around, it is one of the most striking looking. □



## BUYER BEWARE

When backing a crowdfunding campaign, you are not purchasing a finished product, but supporting a project working on something new. There is a very real chance that the product will never ship and you'll lose your money. It's a great way to support projects you like and get some cheap hardware in the process, but if you use it purely as a chance to snag cheap stuff, you may find that you get burned.



**Left**  Light up your letters with little dots of colour



sinclair



Commodo

the

COMPUTERS

THAT MADE

BRITAIN



OUT NOW

*"The Computers That Made Britain is one of the best things I've read this year. It's an incredible story of eccentrics and oddballs, geniuses and madmen, and one that will have you pining for a future that could have been. It's utterly astonishing!"*

- **Stuart Turton**, bestselling author and journalist

.....



Buy online: [wfmag.cc/ctmb](http://wfmag.cc/ctmb)



# LENS

HACK | MAKE | BUILD | CREATE

Uncover the technology that's powering the future

PG  
46

## HOW I MADE: LIGHT PAINTING

The closest thing Gloucester Cathedral has seen to magic since Harry Potter was filmed there

PG  
52

## INTERVIEW: MATT STULTZ

Prusa Printers' community manager on the pandemic, 3D printing, and more



PG  
60



## IMPROVISER'S TOOLBOX: WRAPPING-PAPER

Do something useful with this malleable, seasonal waste product

PG  
32

## MACHINE LEARNING

Add artificial intelligence to your builds

PG  
66



## IN THE WORKSHOP

Join us as we create a unique Christmas PCB decoration



# MACHINE LEARNING

Improve your builds with  
artificial intelligence

By Rosie Hattersley



**S**upermarkets you shop at but never actually scan in anything and where you don't even get out your bank card to pay; ticket barriers that open automatically knowing who you are and that allow you to pass through; apps that pop up on your phone in anticipation of a purchase you're about to make; and keyless cars that just know it's you trying to get into the driver's seat. Artificial intelligence (AI) and data about the individual makes our digital lives slicker and seemingly less complex than ever, but also gives pause for thought about just how Alexa knew we were planning to leave home imminently, prompting an unbidden comment about the traffic or weather. Just as we've learned to accommodate digital assistants and wearable fitness trackers in our lives, so those very helpers have become adept at anticipating our needs, our movements, perhaps even our thoughts.

ML (Machine Learning) is at the heart of much of it. It's a catch-all term for a combination of technologies and products that perform tasks that we humans would previously have done, including a great deal of number-crunching, analysis, and pattern-spotting that is now being used in everything from fashion forecasting, stock market speculation, and gambling to catching signs of serious disease that would otherwise be overlooked. It's also allowing us to explore other worlds without necessarily having a detailed idea of what we – or our electronic proxies – might encounter.

Incredible processing power can be harnessed for good, with trained computers using images and neural networks to engage in deep learning, sorting through millions of pages of data to spot trends or anomalies. But ML is now used almost as much for everyday transactions and in our home technology as it is in industry.

HackSpace looks at just how broad the uses for ML have become, plus how to replicate some of these examples yourself. →

# HEALTH AND FITNESS

**F**itness trackers log plenty of data about the wearer, from how much cardio or other fat-burning exercises they undertook, to the restfulness of the previous night's sleep. Whether you're a Garmin, Strava, Apple Watch, Google Fit, or Fitbit user, they all use data across apps

and devices to build up very detailed pictures of our daily lives. AI uses information accrued by the fitness tracker not only to remind us of our most recent achievements but also to encourage us to do better today, and applaud us for exercising efficiently and having all the right moves. Google Coach uses motion capture to check whether we're lifting weights in line with instructions, while NadiX yoga pants come with built-in sensors and an app containing guided poses. Your smartphone camera recognises when you're in downward dog, and gives a helpful buzz to hint which bit of your body needs to shift to achieve the correct shape.

## DIY AI SELF-IMPROVEMENT

Since you almost certainly have a TV, a webcam, a smartphone, and access to the tools involved in smart exercising, you could follow the lead of other makers and create your own fitness coach.

PoseNet is one of the tools in the TensorFlow arsenal ([tensorflow.org/lite](https://www.tensorflow.org/lite)) of ML apps that seek to understand human (and some animals') movements in order to predict actions.

Given its moniker, it's no surprise to find PoseNet being used by yoga practitioners to help new converts accurately replicate moves. Cristina Maillo explains how she uses TensorFlow and PoseNet ([hsmag.cc/YogaMaillo](https://hsmag.cc/YogaMaillo)) for her YogAI yoga instructor, giving her the push to master the moves first time. Fellow students at the University of Manchester suggested Cristina used the Coding Train ML playlist ([hsmag.cc/CodingTrain](https://hsmag.cc/CodingTrain)) to learn yoga poses and then video herself emulating them. PoseNet analyses her posture and suggests improvements.

Another impressive use of PoseNet sees the same YogAI concept incorporated into a Raspberry Pi smart mirror where, presumably, schedules can be set up to remind the household that





it's time to vacate the couch and get active. The user issues commands such as start, stop, pause, and restart using the Snips AIR voice assistant, while YogAI talks back through the Flite voice synthesiser to guide the yogi to achieve the correct poses ([hsmag.cc/SmartMirror](https://hsmag.cc/SmartMirror)).

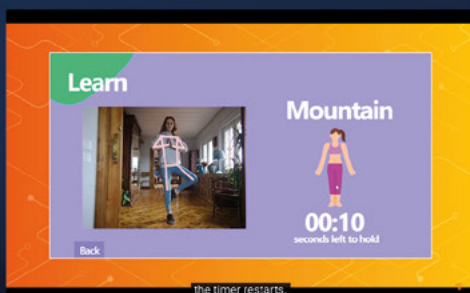
## STAYING FIT; EATING HEALTHILY

You might eat healthily and exercise regularly, but are you capitalising on it all by eating the *right foods* at the *right time* to complement your fitness regime? Breath tests can be used to analyse how efficiently your body is metabolising what you put into it, and also decide whether the next meal should primarily be carbs or protein-based. The Lumen breath analyser (and accompanying app) help you make informed choices, such as whether you need to boost your energy levels with a banana before undertaking a rigorous strength-training circuit, and the best time of the day to load up on carbs. The personalised nutrition monitor is quite needy, however, requiring sustained user readings three times a day, every day for optimal results.

Kutluhan Aktar proposes a less expensive, smart eating option: choosing healthy foods from the outset. His

**Right**  Sensors embedded into the NadiX yoga pants buzz to indicate which part of their body needs to move to attain the correct posture

**Below**  TensorFlow and pose predictions were used to create YogAI – a pose perfecting app



barcode-based nutrient profile project ([hsmag.cc/BarcodeScanner](https://hsmag.cc/BarcodeScanner)) tackles the lack of agreed international standards for indicating how nutritious foodstuffs may be. A combination of ML and a steadily growing database of ingredients and already logged food labels that the device scans and then assigns a 'nutri-score' helps makes the smart barcode scanner really useful. Because of the TensorFlow neural network approach, items that are not logged in the system can be given a predicted nutritional value score, helping users make more informed judgements about their food.

### DETECTING HEALTH ISSUES

As well as checking what we've been ingesting, AI and data analysis of our breath can be used in a non-invasive way to predict medical emergencies that are imminent and the likelihood of diseases such as certain cancers. Research has been ongoing for several decades, based on the premise that if our pets can detect their owners' illness in their bad breath, discernible clues must be able to be identified. A gas chromatography-mass spectrometer (GC-MS) can recognise volatile organic compounds in the air, among the hundreds of which may include fragments suggesting cancer.

In 2018, with the aid of ML, Loughborough University's data science team took on the onerous task of sifting through the huge amounts of data provided from the breath of cancer patients under the care of Edinburgh Cancer Centre, building up mathematical models based around aldehydes, which frequently indicate stress or disease. Unlike humans, the ML approach is not subject to accidentally missing critical information, running out of steam, or error. As well as being cheaper and more reliable, the approach can be used for other types of illness and in different medical scenarios.

Loughborough University senior lecturer Dr Andrea Soltoggio explained in the academic research journal *The Conservation*, "this intelligent software acquires knowledge and improves over time as it analyses more samples ([hsmag.cc/AIBreath](https://hsmag.cc/AIBreath)). As a result, the method is not restricted to any particular substance. Using this technique, deep learning systems can be trained to detect small amounts of volatile compounds with potentially wide applications in medicine, forensics, environmental analysis, and others."

### AI ANALYSIS AT HOME

Epilepsy-and-seizure-prone patients often suffer anxiety in the build up to an attack, and medication taken during one can have undesirable long-term side effects. A seizure prediction device ([hsmag.cc/PredictSeizure](https://hsmag.cc/PredictSeizure)) using a gaming headset hopes to help.

The project, by Salma Mayorquin and Terry Rodriguez, takes its cue from a 2014 Kaggle contest in which entrants

were given 106GB of 'raw intracranial' MAT data as a sample, and tasked with categorising it into preictal and interictal states indicating brain readings just before and between seizures. Data included ten-minute samples for both humans and dogs. With the later introduction of TensorFlow ML and convolutional neural network data processing, the original findings have been used along with subsequent data to make 72% accurate predictions about imminent seizures based on one million samples. The ECG readings can predict an imminent attack, so the patient or their carer can take preventative measures or simply prepare. Researchers used the readily available NeuroSky MindWave Mobile headset, generally used by gamers, and say that they are "well convinced" of the benefits of investing time and effort into training and evaluating a model like this on more data, using Raspberry Pi.

### COLLECTIVE MONITORING

Mozzie Monitors ([mozziemonitors.com](https://mozziemonitors.com)), a citizen science initiative run by the University of South Australia in Adelaide beginning in 2018, discovered it was more cost-effective to send out equipment to interested members of the public to collect large amounts of data on mosquitoes than to run a professional monitoring programme. Researcher Larissa Braz Sousa told the science journal *Nature* ([hsmag.cc/MozTrack](https://hsmag.cc/MozTrack)) that "citizen scientists were able to collect a higher abundance of mosquitoes than professional programmes in the same period, through a low-cost project from their backyards". The volunteer programme cost roughly a fifth of a formal research endeavour with reporting via the free iNaturalist app as well, as based on dedicated traps the researchers sent out to volunteers. →

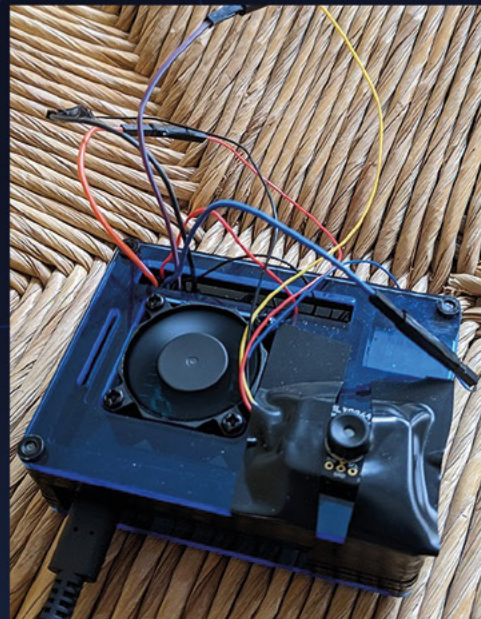
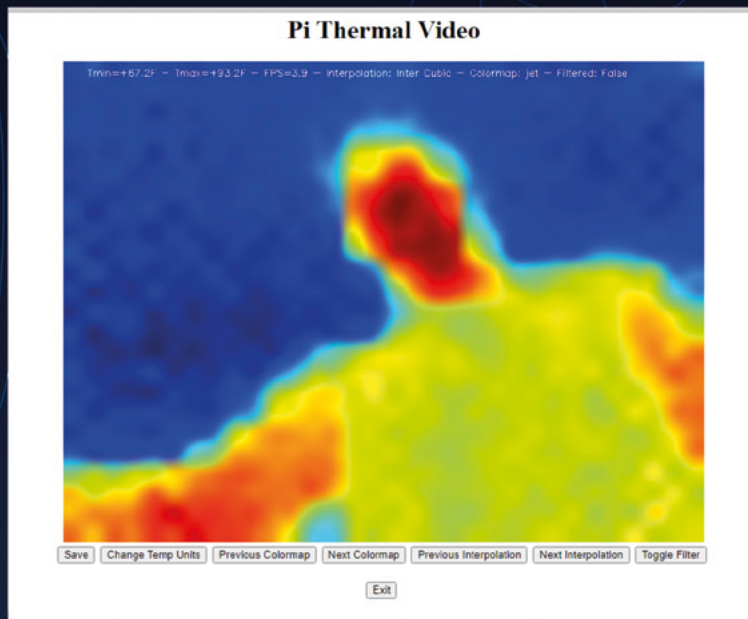
**Below** ♦  
A NeuroSky MindWave Mobile headset was used as part of the seizure prediction experiment



## AI body measurements

Body measurement app Presize ([presize.ai](https://presize.ai)) uses the camera on your smartphone to generate a 3D image of your body shape, which it then stores and matches to the correct clothing size when you shop at online stores that have signed up to its service. The intention is to increase customer confidence that they're ordering the correct size, reducing shopping cart abandonment – only 2% of browsing results in sales, its creators say, while 50% of clothes bought online are returned.

# HOME AI TECH



**M**illions of homes now have voice assistants such as Alexa and Siri, and many are using Apple HomeKit or Google Nest Hub to schedule lights, heating, grocery orders, and other electrical devices. Plenty of people also have video doorbells to provide reassurance that Alexa and Google Assistant are AI-based.

The AIY Kit costs £82 from The Pi Hut and Pimoroni, and lets you build these voice assistants into your DIY projects.

## VISUALISE ENERGY LOSS AND PLUG THE GAPS

Thermal cameras became popular in the US as people began to correlate high temperatures and Covid-19 infections. The technology is useful for detecting hot spots and heat loss, giving it an obvious application in offices and houses. With winter looming, PiThermalCam maker Tom Shaffner set about detecting the parts of his home that were ineffectively insulated. He had Raspberry Pi hardware to hand, and Adafruit had helpfully launched the £54 MLX90640 thermal imaging camera, making for a good-value build that would soon save him money and energy. He consulted existing thermal imaging camera setup guides and an invaluable OpenCV guide to streaming details via the web: [hsmag.cc/OpenCVStream](https://hsmag.cc/OpenCVStream). Tom

then added a Raspberry Pi power bank and wireless connectivity, connecting to the thermal camera using STEMMA QT cables for simplicity. He tried out several heatmapping options, including Matplotlib (which required a high baud rate but produced superior images) and OpenCV, which he settled on using, but importing Matplotlib's superior colour maps and interpolation. Of another option, OpenCV Web Server, Tom says: "If you have a screen for [Raspberry] Pi or you're remoting into it via Remote Desktop or VNC, this works fine. If you're walking around your house trying to use Remote Desktop on your phone to see the video output, [it] can be a pain." He suggests playing around with different colour map settings to get levels of contrast that make problem areas easy to discern. Removing himself – an obvious source of heat – from an area being observed, massively affected the clarity of what's shown, since the live colour map shows the relative temperatures of, say, the air in the room and the colder window panes.

Results-wise, Tom says the 110-degree camera angle sometimes proved unhelpful as it captured so much detail and averaged it out (he recommends the 55-degree version of the MLX90640 camera instead), but the project overall was helpful in determining where the most critical heat loss was occurring. As well as obvious culprits, such

**Above**  Visualise temperature with this DIY build

as lounge curtains left open when the radiator underneath was on, Tom confirmed large heat loss from a garage door with windows and, less obviously, heating ducts above the garage ceiling that lacked insulation, making heating the apartment much less efficient and more expensive. Lagging these and replacing the garage door came about as a direct result of Tom's AI vision project.

### INTELLIGENT CLEANING OPTIONS

The rate of technological improvements since the first commercially successful robot vacuum cleaner, the iRobot Roomba in 2002, is also testament to the soaring demand for domestic helper bots. These robot vacuum cleaners can be expensive to maintain, but they can also be made smarter by adding your own AI expertise to their existing electronics.

### GIVE A NOT-SO-SMART ROBOT A SHARP UPGRADE

When one Roomba owner realised his trusted robot vacuum cleaner was being outsmarted by a rival brand's more 'intelligent' new model, he vowed not to be outdone. Instead, he studied the new Neato Botvac robo cleaning champ, worked out how to add AI to his own model, and then shared the details on The Hookup, his hacking-focused YouTube channel: [hsmag.cc/SmartBotVac](https://hsmag.cc/SmartBotVac). When his wife demanded, "Just make the old one do the new stuff," he declared it challenge accepted.

Investigating the Roomba's construction, he noted an unused PS/2-type port, while online research revealed the robot cleaner's schematics. He soon realised an ESP-01 WiFi upgrade would make for an easy upgrade and added the return-to-charging-base, remote control, and scheduling features the Roomba currently lacked. Using the robot cleaner's open interface, he was able to send the Roomba 500 new commands from his smartphone. An invaluable Roomba Arduino web page ([hsmag.cc/Roomba](https://hsmag.cc/Roomba)) provided some of the Node-RED code needed to get the robot to reveal its battery status and return to its charging base when needed. A few tweaks to the information the Roomba provided meant the smartphone controlling it now showed battery percentage and whether it was charging. Finally, weekly scheduling options, plus the ability to automatically detect when someone is at home and cancel the cleaning regime so that they aren't disturbed, transformed the robot into a far more useful device.

Robot vacuum cleaners can cost well over £1000, so it's unsurprising this \$5 upgrade has earned "legend!" plaudits



from viewers who have been able to replicate these instructions for other models too.

### WHO GOES THERE?

Voice-activated devices have been eagerly adopted for the convenience of being able to ask questions about the weather, travel, recipes, or request songs or factual online searches, but not without concerns relating to privacy and speaker surveillance. If you're already a little jumpy about whether your smart home devices are poised for verbal instructions to switch on the heating or lights, this voice-activated intruder system ([hsmag.cc/PiSpy](https://hsmag.cc/PiSpy)) will not allay your fears. The Spy Audio Recorder project essentially bugs a room,

listening in when it detects a conversation strike up, then transcribing what's said and sending that information to the project owner. Dreamed up as part of a light-hearted Element14 spy nerd challenge, the Raspberry Pi Zero W project sees a mini USB microphone triggered by voices. Fun to follow along and perhaps prank your friends; it's perhaps a little too Big Brother for some people's tastes. →

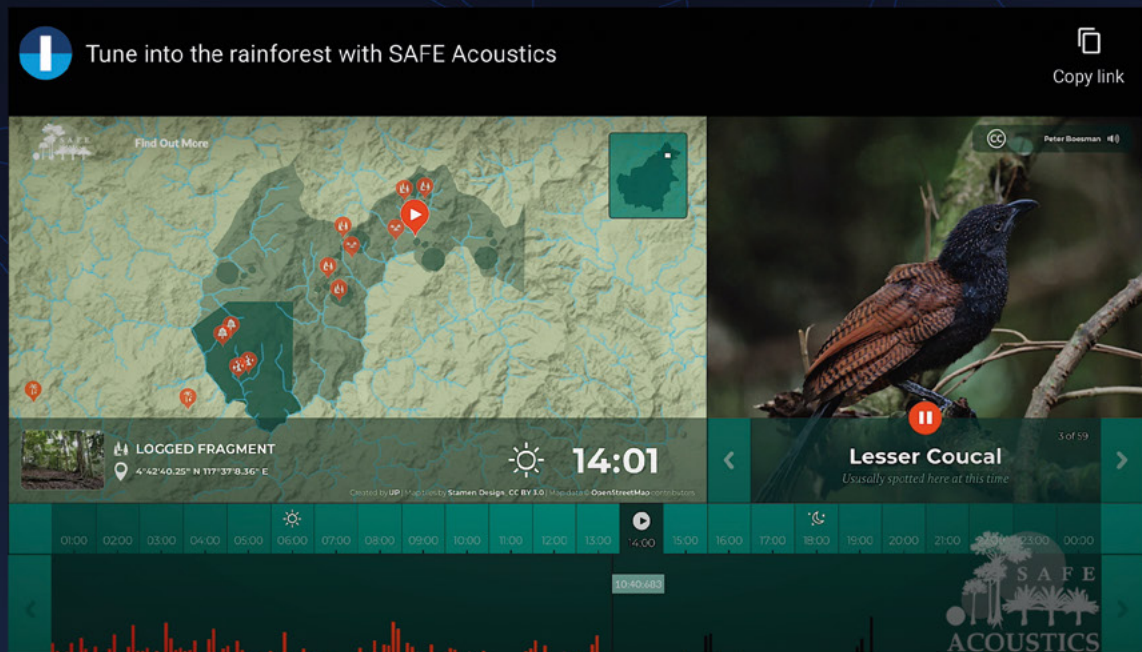
**Above** ♦ Adding WiFi and remote control via an app transformed an older robot vacuum model

**Below** ♦ Add motion sensing to Raspberry Pi with a PIR sensor

## This \$5 upgrade has earned 'legend!' plaudits



# ENVIRONMENT



**W**ildlife identification tracker BearID is one of a number of identity-based conservation endeavours that makes use of Google image recognition tools, highlighting the distinct facial features and head profiles of brown bears. The same technology recently caught our attention ([hsmag.cc/ArtDouble](https://hsmag.cc/ArtDouble)), after Google suggested sharing photos of our pets online and automatically identifying their art world doppelganger.

## TRACK WHAT GOES WHERE


AI and camera traps have transformed the possibilities of wildlife monitoring in even the most remote locations.


AudioMoth acoustic monitoring was first created as a means of identifying nocturnal species such as bats and moths, but is now being used to record and relay soundscapes in the Doñana river delta in southern Spain, and to let

us listen to the dawn chorus in the forests of Borneo. As well as being joyful in its own right, acoustic tracking is a highly effective way to confirm the presence of species that may rarely (if ever) be seen, but whose existence is anticipated in a particular location.

## C-TURTLE LANDMINE-CLEARING ROBOT

Some locations aren't just tricky to access; they're downright dangerous thanks to the prevalence of landmines and hidden explosives. Arizona State University PhD researchers decided to use ML to tackle some of the estimated eleven million landmines left behind in former war zones, building a crawling robot they named a C-Turtle ([hsmag.cc/C-Turtle](https://hsmag.cc/C-Turtle)) due to its appearance and how it mimics a hatchling's movements. The deliberately cheap and simple design uses cardboard flippers to inch forward – the team ruled out using wheels – “they usually have issues with slippage on sand, and they would create a more complex manufacturing process,” and uses a Raspberry Pi Zero. The team can send instructions to the C-Turtle, while the robot is able to process data onboard and make decisions about which route to take based on the terrain it faces. Being able to perform simple data processing and ML directly on the robot was a

**Above**  Machine learning can identify birds from their song

**Below**  A cardboard, foil, and Raspberry Pi Zero robot checks for hidden landmines





requirement for using multiple robots in a fully autonomous fleet, Kevin S. Luck, one of C-Turtle's creators, explained.

### CLEANING UP OUR WORLD

It's no secret that our beaches and seas are clogged with plastic and non-biodegradable rubbish, but efforts to find an intelligent way of cleaning it all up are proving elusive. A number of PhD student projects can be found online detailing attempts to classify plastic bottles or discarded drinks cans, but a reliable litter categorization method has yet to make it to market. The laudable aims of projects such as the LitterBug autonomous trash rover may, however, form the basis of a future rubbish robot, which is one reason why making such projects open-source and available to others is such a great approach ([hsmag.cc/LitterBug](https://hsmag.cc/LitterBug)).

### DIAGNOSING PLANT HEALTH

Computer vision is ideal for comparing how something looks at different stages of its life cycle. Visual clues can also be used to detect problems. Electronics engineer Jonathan Pereira applied the concept to rice plants ([hsmag.cc/DiseaseID](https://hsmag.cc/DiseaseID)), noting that assessing "the process of detecting and recognising diseased plants has always been a manual and tedious process that requires humans to visually inspect the plant body, which may often lead to an incorrect diagnosis". Since crop diseases often spread rapidly through entire species of cultivated plants, time and accurate diagnosis are critical in preventing further crop losses. Jonathan's "transfer learning" focuses on rice plants – chosen due to its critical crop in large parts of Asia, Africa, and South America – in which a dataset of images is used to assess plants based on whether they have healthy leaves and to alert researchers to diseased ones. Rice plants work well for this proof of concept project, since brown spot and leaf blast fungal diseases, as well as the presence of pests, can be visually identified. The visual database idea can be replicated for other plant species.

Transfer learning involved the 'top' layers of a pretrained model being replaced with layers that can learn the features that are specific to the training dataset, making for a far more efficient setup, Jonathan explains. A similar concept aimed at data efficiency was used for the CNN created to warn of an imminent

seizure (page 35), but the accuracy of the datasets needs to be rigorously checked first. For his rice plants, Jonathan noted that the MobileNetV2 pretrained model he was using miscategorized some images on a white background, but accuracy was improved to 80.1% when the images were cropped and the amount of white background 'noise' reduced.


### ANALYSE YOUR OWN GREEN SHOOTS

With photos at its heart, it's no surprise that computerised visual identification quickly made its way to smartphones. A number of apps use photo databases to help discern plant, insect, and bird species – you've probably heard of PictureThis, ChirpOMatic, and NatureID.

There are also apps such as Planta that help you keep plants healthy for longer by setting up a watering and maintenance routine and reminders for you to attend to them. Equivalents for farmers such as Plantix use the image comparison technique to spot problems with a crop, then also suggest remedial action to help rescue the plants. Rather than focusing on chemical pesticides, natural alternatives to spider mite infestations and other common afflictions, such as spraying on basil or rapeseed oil, are suggested. The app has specifically been designed to help diagnose potential problems with staple crops such as wheat, soybeans, bananas, and sweet corn, and for use in places where access to laboratory testing may be less practical.

Should you prefer a DIY approach, keen AI inventor Imetomi explains how to combine the joys of drone ownership with gardening in a fun plant observation project that uses similar ML and image-comparison tools to those described above: [hsmag.cc/GardeningDrone](https://hsmag.cc/GardeningDrone).

**Above**  The beach is a touch environment for a robot

**Below**  Checking on plant health from the skies



# LEISURE TIME



**A**rtificial intelligence (AI) isn't just for domestic chores, driverless travel, and agriculture: it's great for gaming too! Brainwave- and eye-movement-controlled gaming headsets, plus a DIY AI games controller, have their origins in technology developed for amputees and wheelchair users. A mind-controlled means of playing World of Warcraft was developed a decade ago ([hsmag.cc/MindWoW](http://hsmag.cc/MindWoW)), while an Arduino-based option that allows the user to operate Grand Theft Auto controls resulted from keen gamer and NeuroSky controller hacker Imetomi's frustration at the limitations of games available for the brainwave-driven headsets. Detailed instructions can be found at [hsmag.cc/GameThoughts](http://hsmag.cc/GameThoughts).


## BE AN AI GUITAR HERO


Quite a lot of AI involves allowing the app or device you want to use to nudge you to participate, leading to a potentially busy Google Calendar. This guitar progress

tracker cannily knows you want to be able to show off guitar skills, but you need a bit of a stick to encourage you to continue ([hsmag.cc/PracticeSeat](http://hsmag.cc/PracticeSeat)).

Based around an intelligent chair, the idea is you get regular feedback on your axe playing, prompting you to practice more and earn more praise. Needless to say, the idea can be used for other things you need, but there's a lot to like about hacking a seat with an Arduino ESP8266



**Above**  Machine learning to help human learning

**Right**  Machine learning can keep an eye on your cutting





**Above** ♦  
Human artists aren't going to be replaced just yet

that talks to another ESP8266 module to confirm how long you've been sitting, hopefully practising some riffs, and then generates an LED intimation of your awesomeness by way of affirmation.

As maker Bob Clagett explains, other uses, such as using the LED as a visual reminder to stand up, or using the Arduinos to measure your time being quiet and productive, are possible. Full instructions can be found at [github.com/iliketomakestuff](https://github.com/iliketomakestuff).

### AI PRECISION CUTTING

Crafting and cutting tools have proved popular additions to many homes and makerspaces, and AI-based computer vision seems like a sensible upgrade. The xTool M1 has a 16MP camera that uses computer vision and a powerful laser to offer highly accurate cutting, and can be used on a large range of materials, from aluminium and wood to leather and thick card stock ([hsmag.cc/xToolM1](https://hsmag.cc/xToolM1)).

### AI IMAGERY

Inveterate tech tinkerers 8BitsAndAByte think AI can be rather too serious. Instead, they take an oddball approach to applying AI with a caption-generating camera that tells you what can be seen through the shutter ([hsmag.cc/TalkingAI](https://hsmag.cc/TalkingAI)). With the addition of a Raspberry Pi Camera Module Barbara, the talking AI camera captioner, provides a fun introduction to how the image recognition aspect of AI works.

If you'd like a means of sharing snaps and video clips on TikTok, Instagram, and other socials, there's also a zany Instagram option: [hsmag.cc/InstaAI](https://hsmag.cc/InstaAI).

### MAKE YOUR OWN AI-GENERATED ART

Several apps for generating AI-based art provide an introduction to getting creative with maths and neural networking. One of the most successful AI artists so far is Robbie Barrat ([github.com/robbiebarrat](https://github.com/robbiebarrat)), whose GitHub details how to create generative art, such as the reimagining of recognisable portraits and landscapes by some of the world's best-known artists, and even a songwriting mash-up featuring Kanye West. Instructions on using an Arduino and images of plants to create abstract art can be found here: [hsmag.cc/PlantArt](https://hsmag.cc/PlantArt). →

## Artwork

Immersive art, such as the Van Gogh Alive event in London and New York, plus augmented imagery used to impressive effect in shows such as *Strictly Come Dancing*, demonstrate the possibility of computer-generated AI art that reacts to its audience. The LUMA projection mapping show in NY in October ([hsmag.cc/LUMAFestival](https://hsmag.cc/LUMAFestival)) demonstrated just how far it's come, asking event visitors to decide between the human- and AI-generated images based on Edgar Allan Poe's poem *The Raven*. Human creativity narrowly won the vote – this time.



**Left** ♦  
Who needs pictures when you can take captions instead

# SMART TRAVEL



**L**ow-profile autonomous delivery vehicles have been trawling the streets of Milton Keynes, Greenwich, and elsewhere for several years, while self-driving vehicles that log road and terrain details as they go (much like lidar-based robot vacuum cleaners) are now starting to do the same. Elon Musk has been tweeting about the rapid road layout learning abilities of his latest autonomous vehicles, while Wayve.ai announced back in 2018 that its second generation self-driving car was “teaching itself to drive” in just 20 minutes: [hsmag.cc/SelfTaughtCar](https://hsmag.cc/SelfTaughtCar).

This differs from the Waymo and Google Aurora approaches because there’s no need for multiple sensors and to have digested a detailed map in advance ([hsmag.cc/WayveAICar](https://hsmag.cc/WayveAICar)).

Cars themselves have become smarter with the prevalence of owner-accessible diagnostic tools that allow your car’s onboard computer to be hooked up to an Android device or Raspberry Pi to see what’s happening under the hood. Another option is to add car smart in the form of AutoPi ([hsmag.cc/Carputer](https://hsmag.cc/Carputer)), a ‘carputer’ that connects your car or van to the great big cloud server where such delights as Adele’s unshuffled Spotify album vie for your attention

along with Eddie and the Hot Rods. An advantage of the cloud approach is there’s little hardware tinkering to do, and new apps, news feeds, and entertainment options can be added as they come on stream.

## RACE YOUR OWN FORMULA ROBO CAR

Roboracing combines real-life race cars with AI to form a 200 mph hybrid racing car challenge that is just wrapping up its beta series – the last chance for competitors to tweak their autonomously controlled racing cars before the start of the racing season proper. Available to watch via Twitch.tv, Roborace (see [roborace.com](https://roborace.com)) offers an exciting insight into the world of developing a car for both driving and autonomous modes. The NVIDIA DRIVE platform is used for self-driving mode, and each car has onboard GPS, radar, and lidar sensors and cameras. Each team’s Devbot 2.0 all-electric vehicle is the same for each team, but the AI driver software can be tweaked to optimise its competitiveness.

## Cars themselves have become smarter

## AUTONOMOUS ADVENTURES

Self-driving cars and vans grab a lot of headlines, but there are plenty of examples of autonomous vehicles of other sorts. Back in 2009, the University of British Columbia

**Above**  Wayve.ai car driving around London



began designing autonomous sailing boats and soon started collecting trophies from the International Robotic Sailing Regatta. In 2014, they began a new challenge inspired by the Trans-Atlantic yacht race. Named Ada (after Ada Lovelace), the 5.5m autonomous yacht was designed and built by team members, propelled by a windsurfing rig (supplemented with solar panels), and was controlled via Raspberry Pi. After setting off from Newfoundland for Ireland, Ada completed 700km of her 3000 km voyage before a heavy storm damaged her and took her offline. Miraculously recovered 200km off the Florida coast a year later, students used her wreckage to discover what had happened, and use their findings for the next UBC Sailbot, Raye, which is set for a few months' time. [ubcsailbot.org/projects](http://ubcsailbot.org/projects).



### SAIL YOUR OWN ROBOT BOAT

Remote control boats and robots can be taught to avoid obstacles and steer an efficient course, given the right instructions. Coding and sailing enthusiast Wouter de Winter decided theoretical learning wasn't enough, so he set up a two-day course in which participants with existing programming knowledge compete against each other to steer a real sailing boat and win a regatta. A YouTube clip at [ai-captain.com](http://ai-captain.com) shows the ship's rudder being directly controlled by the directions given by the computer, which has been trained by its student navigators. □

**Above** ♦ London's iconic red buses use human drivers, for now

**Left** □ Compete for nautical glory at [ai-captain.com](http://ai-captain.com)

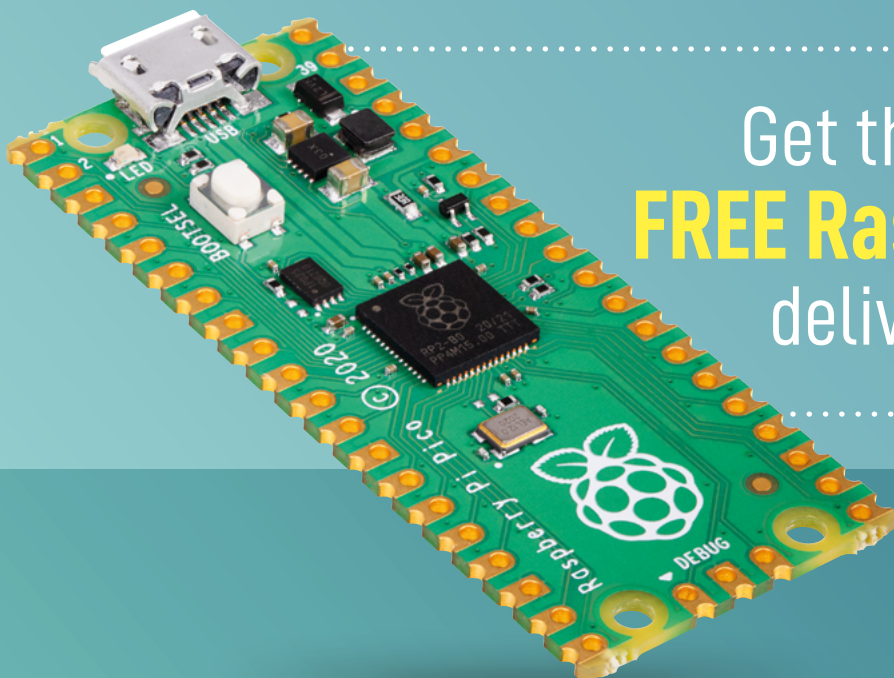


**Left** ♦ Add-on computers can look a little Heath Robinson, but they do work

---

# SUBSCRIBE TODAY

## FOR JUST £10



Get three issues plus a  
**FREE Raspberry Pi Pico**  
delivered to your door

..... [hsmag.cc/FreePico](https://hsmag.cc/FreePico)

UK offer only. Not in the UK?  
Save money and get your  
issue delivered straight to your  
door at [hsmag.cc/subscribe](https://hsmag.cc/subscribe).  
See page 66 for details.

Subscription will continue quarterly unless cancelled

# SUBSCRIBE on app stores

From £2.29



Buy now: [hsmag.cc/subscribe](https://hsmag.cc/subscribe)

Free Pico with print subscription only



MAKE | BUILD | HACK | CREATE

# HackSpace

MAKE | BUILD | HACK | CREATE

TECHNOLOGY IN YOUR HANDS hsmag.cc | January 2022 | Issue #50

HACK | CREATE

Space

hsmag.cc | November 2021 | Issue #48

RP2040  
The best dev boards tested

DIY Music  
Adding long-range radio to a project

DESIGN FIRST  
Circuits permanent ideas into reality custom artwork

BUILD HAT  
Control LEGO with Raspberry Pi

Bubble Wrap PLA

Compressed  
Add elemental power to your workshop

LEGO  
Power up you with LEGO® Technic or Raspberry Pi

Stereo photography  
Explore the magic of 3D images

GLASS PURE DATA

MACHINE LEARNING  
Improve your builds with artificial intelligence

DIY CHRISTMAS LIGHTS  
Control lots of LEDs this festive season

LIGHT PAINTING  
Take photography to the next level

WRAPPING 3D PRINTING PYTHON LATHES

SAVE 44%

HOW

By Didier Briand

I

MADE

# ***PILIGHTPAINT***

Light painting in high definition





## What I used


- ≥ 3 × 125 LED APA102-2020 strips
- ≥ Raspberry Pi Zero W
- ≥ 240×240, 1.3-inch IPS LCD display HAT for Raspberry Pi
- ≥ Matt black aluminium profile and diffuser
- ≥ USB-C power bank with Power Delivery
- ≥ Cables and connectors

“**I**t’s magical!” is the comment that most often comes up when night-walkers come across me during a light painting session. At a time when the possibilities of image manipulation seem to be unlimited, light painting remains a photographic technique that is rather artisanal and yet fascinating. It is about taking long exposures using different light sources.

In this universe, a light painting stick is like a programmable lightsaber; the idea is to superimpose an image on a composition, scanning the space, like a Jedi. The light reflections contribute to the atmosphere of the final result.

The photographer Michael Ross popularised this technique. The genesis of Pilightpaint is due to him. Indeed, the rise of smart LEDs has expanded the creative possibilities. HackSpace magazine previously illustrated the concept of ‘writing with light’ in issue 15.

However, the open-source projects initiated by Adafruit, or the products marketed for a few hundred dollars, still have this effect of lines and pixelation linked to too low a definition. I was convinced that I could do better for less... or, at least as well, for the same price with the satisfaction of controlling the whole process. →

**Above**  By carefully dialing in the diffuser, I avoided striping

**“SEVERAL COMPONENTS ARE 3D-PRINTED”**

### IN SEARCH OF EDUCATIONAL PROJECTS

I am a teacher in STEM, and I am always looking for educational projects that combine creative aspects and technical knowledge. Light painting is a perfect example.

During a session, the students program a strip of eight WS2812 LEDs; the objective is to produce a photo inspired by pixel art. I am amazed at the fascination that light can have on teenagers. If one can get the feeling that they are sometimes bored by

the effervescence of technology, turning on an LED and controlling its colour with a few lines of code gives them real satisfaction.

### A HIGH DEFINITION STICK

The Pilightpaint is the improved version of this activity! It consists

of a 375 LED RGB strip of the type APA102-2020 on 1 m 50, i.e. a resolution of 250 LED/m. It is controlled by a Raspberry Pi Zero W coupled with a 1.3-inch LCD screen. The power supply is provided by a battery that can deliver up to 3.6A.

Several components are 3D-printed to match the exact requirements: the protective case, the fixing clips for cables and accessories, the LED holders, and the profile joining elements. After testing old coloured filament spools I had in stock, I finally opted for a matt black PLA to eliminate unwanted reflections. Finally, the aluminium structure offers a good compromise between rigidity and lightness, despite the fact that the object takes up some space.

### THE HARDWARE

The project requires three independent strips of 125 LEDs: type APA102-2020, 500mm long, 3mm wide. This type of LED has the advantage of a better rendering compared to the classic WS2812B. I soldered the three modules end to end, taking care of SPI bus direction and having removed the superfluous connectors beforehand. Unlike an LED strip which is flexible, the modules are made of a 1mm thick PCB. So I ended up with an extremely fragile 1m 50 long and 3mm wide PCB.

The LEDs are very close to each other – my main concern was damaging the ones at the ends when joining the strips. The copper layer is still fragile in this area where the soldering is to be done and the connectivity was not assured during the first test. I had to reshape and sacrifice two LEDs for perfect signal continuity. Thus, the final resolution of the Pilightpaint is 373 LEDs. I still remember the special moment when all the LEDs finally lit up!

In order to stiffen the whole and to better control the light diffusion, I fixed the rod on a matt black aluminium 15x15mm profile. Although I had opted for a wooden strip

**Below**   
Reflections in water can yield excellent results







**Left** ↵  
The diffuser (left) smooths out the light of the LEDs

HOW



**Right** ☑  
Images don't have to be complicated to work well

in my first versions, my wish to obtain a better quality product led me to this rather restrictive solution... I had not properly assessed the consequences of such a decision!

As the saying goes, 'Perfect is the enemy of good' – when you want to improve something, you sometimes come up against unexpected difficulties.

For reasons of availability and transport costs, I chose 1 m long profiles that I had to join rigidly after several attempts. Moreover, it was no longer a question of simply gluing the LEDs to the bottom of the profile. On the one hand, aluminium is conductive; on the other hand, I wanted to be able to adjust the distance to the diffuser. So I modelled in Fusion 360, and then printed about 15 brackets that form the interface between the profile and the LEDs.

**PROGRAMMING**

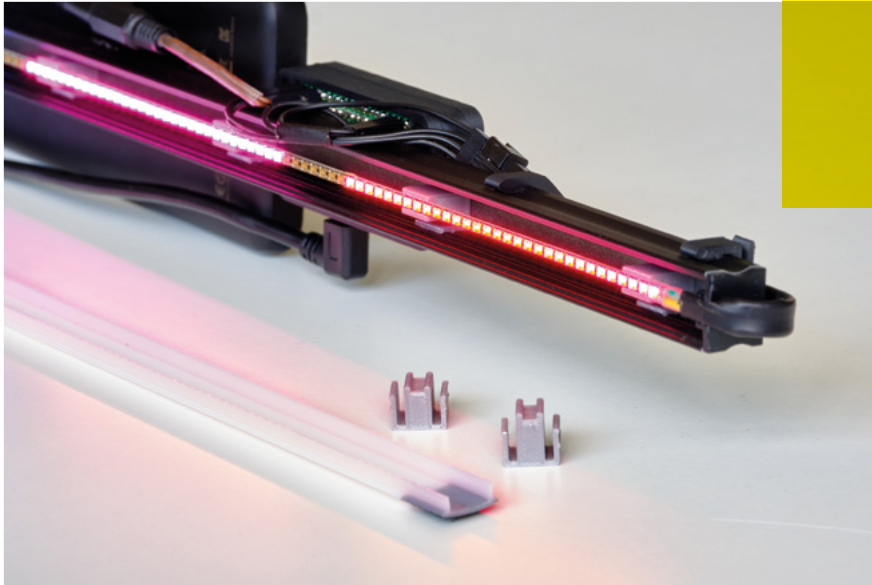
The programming is handled by two Python scripts: the first one manages the conversion of an image by transferring each pixel to the stick with a defined frequency. It is a fork of a program by Phillip Burgess shared on the Adafruit website. The second one controls the interface via an LCD display and a five-input joystick. It is an evolution that I wanted to make easier to use, and I developed it entirely.

In my first version, the stick was controlled by an Android application via Bluetooth. I spent a lot of time solving connectivity and pairing issues for the Python scripts. I was using my smartphone as a remote control to select files, set the lighting time, or trigger. However, →



**Left** ☑  
This image is not photoshopped

## FEATURE



**Above** ↕  
The closely-packed LEDs give great image quality

restricting the physical buttons was not very practical because I had to juggle between my phone, the stick, and the camera remote!

Waveshare offers several compact interfaces for Raspberry Pi. A screen displays information, and a joystick with buttons allows you to interact with the Raspberry Pi. In addition to the above functions, the Pilightpaint offers a self-timer, brightness management, directory navigation, horizontal and vertical reversals, or iterative advance for animations.

### LET THERE BE LIGHT!

The diffusion of light remains the essential point of this project; too pronounced, we lose sharpness, not enough, and we will notice the trace left by each individual LED during the shooting.

So I selected a milky-white diffuser that did not attenuate much, and I precisely



**Right** ↕  
Keeping the unit portable and easy to use is key to great photos

adjusted the distance between the PCB and the diffuser with the help of the printed brackets to be at the limit of the overlap between two consecutive LEDs.

### FINAL DETAILS AND FINE TUNING

The pitch between two LEDs is only 4 mm, and the casings are 2020 type, so I had to leave 1 mm at the ends of the sticks before soldering. Nevertheless, I had to re-adjust a junction in order to correct a gap of only a few tenths too large that remained perceptible in the shots. The idea is not to do things perfectly but well enough to make it work, so it is always difficult to make the decision to remake with the risk of worsening a situation.

During the development, I had tested different display solutions. I first used a monochrome OLED display driven by I2C. However, I was confronted with a lack of reactivity. By using the SPI protocol for the display, I improved the fluidity considerably, but I could no longer use the LED strip as it uses the same port! Fortunately, the Raspberry Pi Zero W offers a second SPI port, but again it was using the same GPIO as the function buttons of the LCD display HAT! In the end, I had to adapt the interface and control the stick using only the joystick. I also opted for a 240×240 LCD screen, which provides a good quality and colour display of the selected image files.

Potentially, the Pilightpaint's power consumption could reach 100 watts! During the first tests, the voltage drop when lighting the stick caused the Raspberry Pi Zero W to reboot randomly. Fortunately, the program limits the brightness to a more reasonable value. One solution would have been to separate the power supplies and dedicate a battery to the Raspberry Pi Zero W, but this was at the expense of weight. In the end, I found a better-performing standalone battery that delivers the power needed for the lighting. In this phase of development, I also optimised the boot time to come back to a shorter time of about 20 seconds.

## THE USE

For a light painting session, I prepare image files according to the location. I generally transfer them by FTP from my computer to the Pilightpaint, even if I have kept the possibility of using a USB flash drive or Bluetooth. I try to visit the location during the day to test the composition.

The idea is to play with the light and its reflections at twilight. I appreciate abstract figures as much as figurative images. Ironically, I can play with the pixelation of the image and give it a flickering appearance. As I often work in a humid atmosphere in order to deal with the reflections of water, I have also improved the resistance to splashing.

It is these subtle improvements that contribute to the final result of the photos, and I am always looking for ways to improve. Many people think that the images are photoshopped when, in fact, everything is done in real time during the shooting. My wish is that the technique fades away in favour of a dreamlike composition.

## WHAT NEXT?

The expected cost is around €300, mainly due to the LEDs. It is lower than the cost of a commercial product like the Pixelstick, while still meeting my needs. I'm considering developing a dismantlable version because transport is not always very practical and I would like to improve the interface. I'm also keeping an eye on the evolution of smart LEDs.

The Pilightpaint opens up creative possibilities that I have only scratched the surface of. You can find my creations on my Instagram [@mulholland77](#). Remember that only a few LEDs allows you to have a great experience in light painting! ▣

**“EVERYTHING  
IS DONE IN  
REAL TIME”**

### Below

I'm still learning, but really pleased with the results so far



HackSpace magazine meets...

# Matt Stultz


A true believer in 3D printing

**S**ome people know as children what they want to do when they grow up; they do their professional training, then stay in that one niche until they retire. Not so with Matt

Stultz. He's been a writer, editor, maker space founder, digital fabrication expert, maker, and more (including a time spent ensuring that McDonald's fries made it to every corner of America). He's now the community manager at [prusa3d.com](http://prusa3d.com), and works on the file sharing site set up recently as a competitor/complement to the better-known Thingiverse. He's seen the good, the bad, and the ugly of 3D printing, and we loved hearing about it. →



Credit: (c) Prusa Research - prusa3d.com

**Above**  Matt (seen here on the left, with Josef Průša) lives and breathes 3D printing, not so much for the technology as for what it can do for humanity

**HackSpace** You've been involved in the maker community for a fair while, at Make Magazine, at MakerBot, and now at Prusa. How did it all start?

**Matt Stultz** I started out as a software developer. I was writing software [for] airline reservations; I've written software for restaurant logistics, the biggest being, for example, tracking how many trucks of French fries McDonald's had going around the country. But I was always interested in making stuff and doing stuff, and around that time, the maker world started to become more accessible.

So I started playing around with microcontrollers, and then Arduino came out. It was so much easier, so much more cost-effective. Because you didn't have to worry about expensive software for some of the compilers; you didn't have to worry about, you know, expensive dev boards and programmers and everything else.

And so I started playing around with Arduino, and was really enjoying it. But, you know, I had questions, and there were things that I was trying to figure out. And so I started saying, like, hey, maybe what I should do is start an Arduino meetup group – you know, get together once a month, and talk about this thing. And in the back of my head, you know, I'm hearing about places like NYC Resistor and Noisebridge out in San Francisco, you know, all these hackerspaces getting kind of started. And so I thought, maybe one day if I start this Arduino meetup group, we can like, transition that into sometime becoming a hackerspace.

And then I started hearing about this other guy who wanted to start a community auto garage – sharing space and tools and things like that. And the two of us sat down, and we basically were like, well, let's just start a hackerspace, let's just do it.

We put out a call to makers in the Pittsburgh area and said, if you're into the stuff that you see in Make Magazine, if

you're into, you know, software development and hardware development, and you want to hang out with fun people who want to make stuff, we're going to start this thing. By early to mid-2009, we had formed HackPGH, which still runs to this very day.

We were doing all the fun stuff, the space balloons and playing around with the early MakerBot cup-cakes, you know, and other kinds of RepRap stuff, teaching Arduino classes. We started showing at Maker Faire Detroit; we went in 2011 and showcased a load of our members'

By early to mid-2009, we had formed HackPGH, which still runs to this very day

projects, including the Cheese Bot, which was a 3D printer that printed in cheese.

**HS** Doesn't that clog the nozzle?

**MS** In America, we have this cheese called Easy Cheese. It's inside an aerosol can.

**HS** [Audible shock]

**MS** Anyway, I built a robotic gantry and controlled it via an Arduino, and we programmed it to write kids' names on crackers. The beauty of that was that even with a failed print, you'd have something to eat.

One of the big things that we were doing at the time was playing around with 3D printing technology. One of my very good friends at the time was really active in the cup-cake community, and he was also an extremely talented software developer. I got a call from him asking me if I'd go and work on Thingiverse.

The best thing about working for Thingiverse at that time was the people that you met. I had already known Becky Stern to some degree, and I already knew Matt Richardson – they were filming weekly podcasts for Make from within MakerBot at the time, so I'd see them more, you know – there's plenty of people within that organisation that have gone on to do all kinds of things. You learned so much because we were all so obsessed with the maker thing, everyone who was working there ate Arduinos for lunch, right? It was part of their being.

And so you learnt so much about 3D printing, you learned so much about making things and software and microcontrollers and everything else. And so when I left Thingiverse, I left with those relationships, and a lot of the knowledge that came out [of that period].

But anyways, along the line, my buddy Matt Griffin from MakerBot got in touch about doing a big review of 3D printers for Make. I couldn't do it the first year, but the second year for the 3D printing shoot-out, they were able to get me on the team.

**HS** Was it just 3D printers you were looking at?

**MS** We were getting more and more affordable laser systems, CNC systems, everything else. Makers who now understood 3D printing wanted these other things too. So then we started bringing in everything from 3D printers the whole way up to desktop water jets. And after I did the digifab editing, I would end up being in charge of all reviews.

**HS** So working at MakerBot, Make, doing Maker Faires – that's set you in good stead for a community role at Prusa?

**MS** I went over to Prusa and joined up as a head of community role. That has taken some twists due to Covid, but initially the plan was, let's get people on board with Prusa Printers. We're the new kid on the →



**Above** 📌


One way of explaining 3D printers to people is that they work like hot glue; unless you happen to be in New York, where nobody knows what hot glue is (according to Matt)

▲ 26.0° Z 0.15?  
■ 26.0° >100%  
---  
Prusa i3 MK3S OK.

Credit: (c) Prusa Research - prusa3d.com



Credit: (c) Prusa Research - prusa3d.com

**Above**  There's a film on Netflix called *Print the Legend*, which Matt recommends as a snapshot of the early days of desktop 3D printing



block; how do we build more community around Prusa Printers? One of my first thoughts was about going back to starting 3DPPVD, this monthly meetup around 3D printing. I had convinced two of my buddies, who were on the testing team, to follow the same model, and they had formed 3DPPH in Pittsburgh.

I started going to maker spaces around the country and hosting Prusa meetups. I would email all of our customers that were in the area and say hey, we're coming to town, let's hang out. I'll buy the pizzas, I'll buy the beer, you guys come, and let's talk about 3D printing. It was great!

Prusa, in my opinion, lives and dies by its community. And not just Prusa; I think we've seen this across the entire 3D printing world. No one in the desktop printing world can survive without having a fan base, a community. We have the resources and the knowledge to embrace our community and do more with our community. I was going around trying to get these meetups off the ground, starting them up and then finding someone to take it on without me. I was doing that quite happily, then the holidays rolled around, and nobody was doing much over the holidays anyway. And then we started hearing about this virus that's going around, and it became not a great idea to get a whole bunch of people in a room together.

**HS** And then anybody who knew anything about 3D printing was making face shields.

**MS** I think Prusa really jumped in very quickly on everything. The way that we handled Covid internally in the company is a shining example to a lot of companies on how to do things. We quickly realised that we had all of the equipment needed to make hand sanitizer, in a time when it was almost impossible to get. Prusa went into production and was giving out free bottles to its employees. There was

already a security system of badging into the factory and stuff like that, but they put in thermal cameras as well to check if people were sick before they were badging in. When all the face shield stuff came up, they [Prusa] got deemed an essential company and so could stay open, and they really did take it to heart that it was their responsibility to keep people safe. They continued shipping things not only to their customers, but also to people who were using these things for good.

I don't want to toot our horns on this, but we were sending out hundreds of kilos of free filament to people making face masks. The company itself produced hundreds of thousands of face masks internally that they gave away to

"

We quickly realised that we had all of the equipment needed to make hand sanitizer

medical organisations in the Czech Republic and other parts of Europe. It's important to talk about this stuff, but they didn't do it for press; they did it because it was the right thing to do.

They discovered that they had someone at work who had a background in cutting hair, so they set up a barbershop on the roof. That was such a quality of life thing for the employees. They ended up buying one of the Covid testing machines and hired a nurse to do on-site Covid testing, so all employees could go and get tested whenever they wanted to at the factory. Those guys really put effort and thought into keeping operations going, but also keeping their employees safe. Was it the cheapest thing to do? No. Did we keep the factory open? Yes. It kept production going the entire time.

Early on they realised what they could do with the hand sanitizer, but they

couldn't sell it, and they couldn't ship it; it wasn't something that the community could easily contribute to, so they looked into what would make a difference. A lot of people were talking about masks, but that wasn't something that could be done fast and easily with 3D printing. But face shields could.

You had all of these people who were putting their lives at risk; all these doctors and nurses nothing the PPE that they needed. And so Prusa said, face shields are something that you need; face shields are something we can easily make. So they started work on a design. It went through many different iterations, constantly improving, until they got it certified for use by the Czech health department. In the US we had situations where makers were trying to give masks to hospitals and hospitals were refusing them because they weren't certified.

They churned out thousands and thousands of these things, but as is the case with all things Prusa, they also open-sourced it. We had tons of people downloading these face shield files – it's still one of our most downloaded items on Prusa

Printers. I produced almost a thousand of them right here in Maine.

We took it a little bit further by using the communities we'd built to do more. At that point we created this thing that we called Groups, making it easy to coalesce into communities with shared interests. We saw a lot of people created Groups on Prusa Printers; I think they quickly migrated over to Discord and other servers for their main communication, but the nice thing was that it gave people a place to go and look.

**HS** That is the hard thing about the internet. A lot of the time you know the information is out there, but finding it is impossible.

**MS** Beyond even information, it's that hard thing about community and the internet. Finding people who have that →

same like-mindedness, and hopefully finding people that you can jive with.

The Prusa Printers community is great. Thingiverse is a behemoth. It's the white whale. It's like if Moby Dick had a love-child with a megalodon. It's a tough nut to crack, and we know that; we have no illusion that we're going to replace Thingiverse in a week or a year. But we're invested in it. And not only in trying to supplant Thingiverse, but we're more interested in making the tool that the community deserves.

I'm a true believer in all this stuff, it's worth saying. I think 3D printing is changing the world, and it's going to change the world even more. I look at 3D printing technology in the same way as computers and PCs. There was a time when people asked the question, 'who needs a computer in the home?' And now,


how many computers can you reach out and touch right now where you're sitting? Your phone, your laptop, however many Raspberry Pis are near you, and everything else. I think that a lot of people have similar doubts right now about 3D printing, 'why do I need a 3D printer in my home?' But I think that is going to change. I think we saw that in the 1950s with microwaves. 'Why do I need a microwave when I already have an oven?' We all have microwaves now. As 3D printing technology gets better, it's going to be adopted more. I also think that, much like computers needed that killer app of spreadsheets to make them useful, 3D printing needs that killer app.

It might not be that there's one particular print that becomes the killer app as much as having a repository of prints that you can search for when

you need them. Knowing you can go to Thingiverse, or go to Prusa Printers and find the files for the things you need to fix.

I see a site like Thingiverse as being at the same level of usefulness as Wikipedia is now. Wikipedia is this huge resource for being able to find all sorts of knowledge. How often do you Google for something and you're just looking for the Wikipedia entry on it?

We haven't really embraced the concept yet that everything we need in the future is going to be a download and a print away. Excluding some of the electronics and things like that, but if I need a cup, or a measuring spoon, I can just go download one. The global impact of these things is huge: we're dealing with climate change, we're dealing with a world where we have oceans full of

**Right**   
Despite the name, the prusaprinters.org site isn't just for owners of Prusa printers. As Matt says, "Prusa Printers is an awful name and we know it!"



Credit: (c) Prusa Research - prusa3d.com

plastics, and a lot of people look at 3D printing and think we're just contributing to the overall plastic waste.

But there's a point where that could change, very, very rapidly. We're heading for the Christmas shopping season now, and there are tons of companies making bets that their little stupid plastic toy is going to be the Furby of the year, that it's going to be the big hit. So many toys at the end of this Christmas season will end up in landfills because they were not a success.

What if we stopped buying the plastic rubbish from Walmart and Tesco or wherever and instead, when we need that plastic item, we make it. We just make the thing that we need, and the 50,000 others that people don't need don't get made in the first place.

There's a big opportunity for the environment here, but we need sites like Thingiverse and Prusa Printers because not everybody is a designer. Not everyone can design a new coat hanger, for example; they need a place where they can go out and just get one.



We need to find ways for designers to get the money and the attention they need so we can build them up and they can continue contributing to the community; on the other hand, I think we've seen a rise in the Patreon designers and stuff like that. I love Cults, I love MyMiniFactory, but we see a lot of people who are taking their designs instantly to these sites. If you're a designer and you've made, say, a box that perfectly holds AA batteries, you might think it's really cool and sell it on MyMiniFactory for a couple of bucks. But you wouldn't have been able to do anything of that without the open-source community. There's a happy medium to be found; I'm just not sure where it is. We need to support these people, and we also need to support the wider community. I still think sites like Prusa Printers and sites that are giving things away for free are important to the overall picture.

Because not everyone is going to want to pay \$2 for the design for that box all the time. And even though that box would probably cost more if you went to Walmart and bought the physical object, when they think about the time they're going to spend printing it and the cost of the filament, plus the cost of the design, in your head that might get too expensive. But if that design is free, it triggers something else; the cost of the material and cost of the time and energy of printing it almost goes away.

I still think that free access to these designs is the thing that's going to bring in this punk rock, Fugazi-esque idea of 'make everything and do it yourself'.

**HS** In order for a design download site to be useful, there's got to be some guarantee of quality, though, that, in theory, the market should provide. How do you stop any site from being flooded with rubbish?

**MS** Exactly. How many key chains does the world need

with someone else's name on them? Multiple, very slightly customised versions of the same thing looks great on numbers, but it's also unwieldy. Thingiverse is the Hoover, or the Kleenex, of 3D print sites, just like MakerBot used to be with 3D printers.

It's going to be a slog to overtake Thingiverse, but it's an important battle. A big reason I came to work with Prusa is that they get it. When I sat down with Joe [Josef Průša], I was clear that if Prusa Printers was only there as a money-making stream and they were going to figure out how to monetise it in a year or two; I wasn't interested. We had a big discussion about it and realised that we're on the same page, that Prusa Printers is one of the things that the community needs in order for 3D printing to fulfil its potential in the future. We're going to make the best tool that's out there, and we're going to keep improving it.

The machine, the Prusa printer that you buy today, is going to be a better machine in a year than it is today, and you can't say that about most products on the market. That's because they're going to keep updating firmware, they're going to continue updating the slicing software, they're going to keep pushing free upgrades to you. Sure, there might be hardware upgrades, too, but just software-wise, they're going to continue

pushing things forward, and we're doing the same with the Prusa Printers site. □



**Left** □ Prusa's SL1 is the company's first foray into resin printing

# WRAPPING PAPER



When it comes to giving, it's the thought that counts but the wrapping that remains. Rosie Hattersley offers some reuse options

**Whether you're a Christmas fan, a Christmas Grinch, or simply don't celebrate the annual festival of consumption, it's fair to say there's no avoiding the sheer amount of Yule-related**

**paper and pap around right now.** In fact, the whole industry relating to gifts and celebrations seems to generate an inordinate amount of stuff that is almost instantly discarded.

Often, the wrapping that adorns thoughtfully chosen gifts is gossamer-thin and more ink than pulp. Such examples are best reused for their vibrant

Decent quality wrapping-paper can, of course, be retained, smoothed out (gently ironed, if you must), edges trimmed off, and used to wrap future presents. Depending on the design, the pattern repeats may make for interesting festive decorations such as paper lanterns, while small pieces could be used as liners to give a Yuletide feel to otherwise plain crockery.

Wrapping up gifts to disguise them has been a 'thing' for nearly 2500 years and, as with so many traditions, the Chinese and Japanese were early adopters. In Japan, gifts are artfully wrapped in fabric, while printed paper wrap originates from the 2nd century BCE Song dynasty, but was popularised in the US in the second decade of the 20th century. It's an industry now worth \$17 billion annually, with some of the best-loved designs reissued as limited edition classics and their originals preserved in museums: [hsmag.cc/ClassicWrap](http://hsmag.cc/ClassicWrap).

As your last few weeks have probably attested, the cost of wrapping-paper soon mounts up, in which case, as well as finding canny ways to reuse gift wrap you've already got, you might want to print your own next time, with help from the V&A's handy guide: [hsmag.cc/WrappingPaper](http://hsmag.cc/WrappingPaper).

shades and kept well away from damp, but even the cheapest sort of wrapping-paper can have a worthwhile afterlife. In fact, the malleability of cheap gift wrap makes it perfect for papier mâché.

**"OFTEN, THE WRAPPING THAT ADORNS THOUGHTFULLY CHOSEN GIFTS IS GOSSAMER-THIN AND MORE INK THAN PULP"**

# GIFT BOXES

**Get ahead in the present packaging stakes by using both used and offcuts of unused wrapping-paper to clad ordinary card or cardboard as festive, birthday, or other celebration-themed boxes.** You could even cut up an old greetings-card for this. The simplicity of this project, which involves gluing and smoothing down your chosen wrap onto stiff card, makes it an ideal way to amuse the kids between Christmas and New Year too (or involve them in the gifting process at other times of the year). First,

create a box template: simply draw six squares in a long t, plus tabs to glue the pieces together. Cut out the card template and make as many copies as you need to create multiple boxes. Place a card cutout over the area of wrapping-paper you want to use, if you want a particular section of the design to be prominent. If it's an all-over pattern, you can simply glue the card to the back of the paper. For a two-part gift box using thicker paper stock, the video tutorial on [thriftdiving.com](http://thriftdiving.com) provides great instructions, in which the paper is folded double to make it a bit sturdier. →

**Project Maker**  
**THRIFTDIVING**

**Project Link**  
[hsmag.cc/GiftBoxes](http://hsmag.cc/GiftBoxes)



**Left** ♦  
DIY christmas boxes are a cheap way of getting great-looking presents

# PAPIER MÂCHÉ SCULPTURE



**Right** ♦  
Wrap paper and glue around a balloon to create a mask

**Below** ♦  
Turn your Christmas wrapping paper into a festival sensation

**S**hedding wrapping-paper to pulp and using for decorative crafts is one of the most obvious ways of reusing it. Unfortunately, being saturated with colourful dye makes old gift wrap unsuitable for use as pet bedding, but the bright shades really lend themselves to DIY lanterns and lampshades. In fact, the thinner and more flexible the paper the better when it comes to applying it as individual sheets, or mixing it with

water and glue to create a wet pulp. The classic way of sculpting is to use a form such as a bowl or a balloon that you pop once the papier mâché has dried out, as in this balloon lantern project [hsmag.cc/BalloonLantern](http://hsmag.cc/BalloonLantern). Iconic Manchester figure Frank Sidebottom was made in exactly this way, as his creator Neil Donoghue explains: [hsmag.cc/FrankSidebottom](http://hsmag.cc/FrankSidebottom).

For real impact, you could use rods, wheels, and other elements, especially if your sculpture is intended for public display and admiration. Colombian artist Daniela Batalla's Kilele Head mascot, for the 2020 St Kitts Festival, uses a combination of paper pulp, newspaper, glue, paint, and improvised props to brilliant effect, as you can see, and was really taken to heart by festival-goers: [hsmag.cc/StKittsHead](http://hsmag.cc/StKittsHead)



# FURNITURE MAKEOVER

**K**itsch home furnishing upcycling company Muck N Brass has some fantastic options for creating a visual impact using small amounts of wrapping-paper, wallpaper, paint, and glue. The company's maximalist approach to making over dressers, wardrobes, and chairs often involves wildlife designs, as seen in this YouTube demonstration [hsmag.cc/MuckNBrass](https://hsmag.cc/MuckNBrass), but can equally be applied to wrapping adorned with festive scenes and celebratory themes. As well as incredibly careful image or pattern placement, hours are spent preparing the furniture to which paper is to be applied, after which, lashings of protective lacquer is required.



**Project Maker**  
**MUCK N BRASS**

**Project Link**  
[hsmag.cc/MuckNBrass](https://hsmag.cc/MuckNBrass)

**Left** ♦  
Do you love Christmas enough to have wrapping paper on display all year?

**Below** ♦  
We wrap gifts in paper, why not people?

# WRAPPING-PAPER DRESS

**C**elebrating gift wrap in all its kitschy, gaudy glory, AvantGeek's showstopping dress doesn't just riff on the decadence of festive wrapping-paper designs, her highly original garment is actually made from the very stuff her presents came in. A second version, also

made from gift wrap, atones for having been remiss about recycling and, instead, uses leftover rolls of wrapping-paper for a more considered design. As she comments, the amazing creation has a fairly structural quality to it – so much so that, when left unattended, the wrapping-paper dress doubles as a cat fort! □

**Project Maker**  
**AVANTGEEK ART**

**Project Link**  
[hsmag.cc/WrapDress](https://hsmag.cc/WrapDress)



# Wireframe

Join us as we lift the lid  
on video games



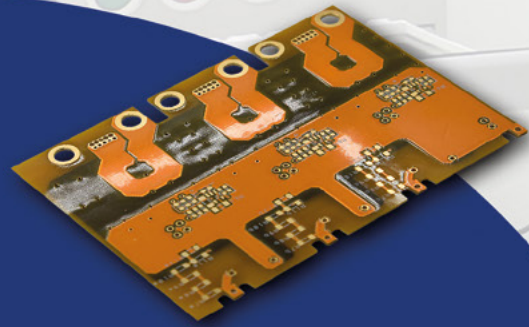
Visit [wfmag.cc](http://wfmag.cc) to learn more





- High-Quality PCBA with component sourcing
- Start from only **\$30**
- Free stencil & Free shipping all over the world

## Turnkey PCB Assembly



- Instant quote online & User-friendly web interface
- Fast turnaround in **24 hours**
- Make your unique and high-end products the easy way

## Advanced PCB Fabrication

**Quality  
Guaranteed**

## 2021 Year-End Big Sales

- Free Coupons Giveaway (1st.Dec - 31st.Dec)
- **Up to 52% Off** for 3D Printing & CNC Machining service
- 3 chances to play the lucky draw and win electronics modules and useful tools



## More Custom Options

- Professional Flex/Rigid-Flex PCB
- New soldermask colors: **Pink, Gray, Orange and Transparent**
- Perfectly implement your idea with different types of PCB



More information:  
[www.PCBWay.com](http://www.PCBWay.com)

Email:  
[service@pcbway.com](mailto:service@pcbway.com)

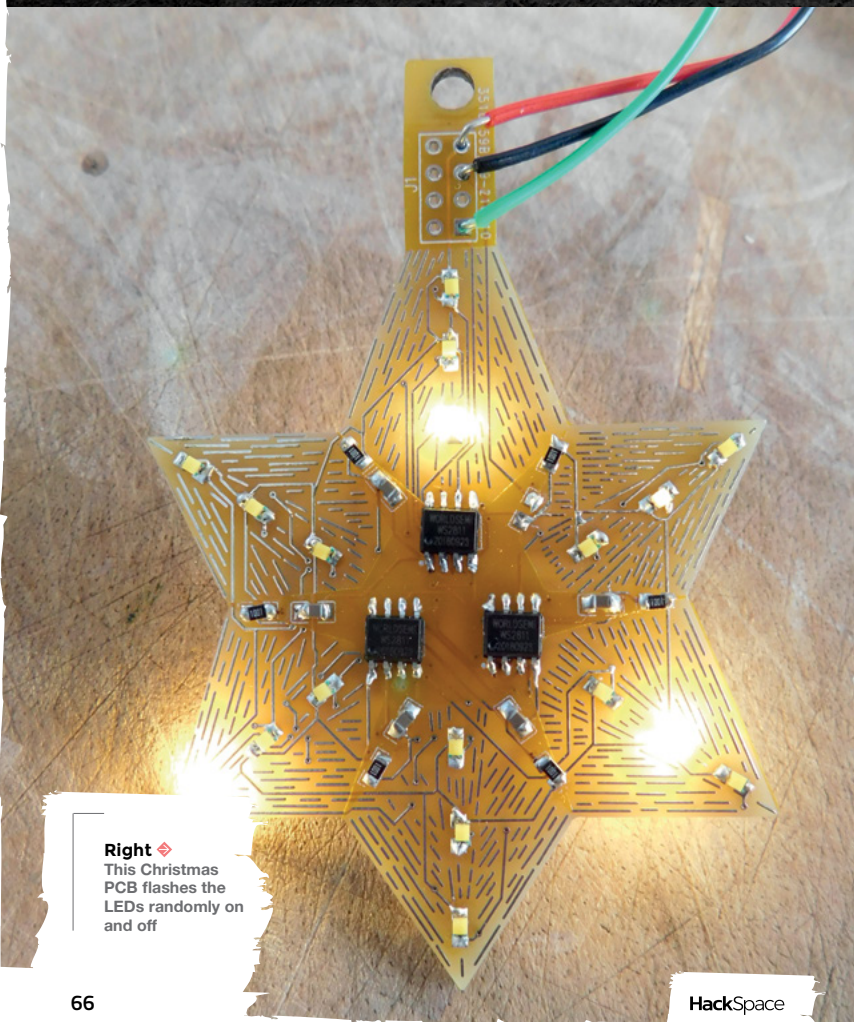
Phone:  
(0571) 8531 7603

FEATURE

# IN THE WORKSHOP: Christmas PCBs

By Ben Everard

Making artistic PCBs



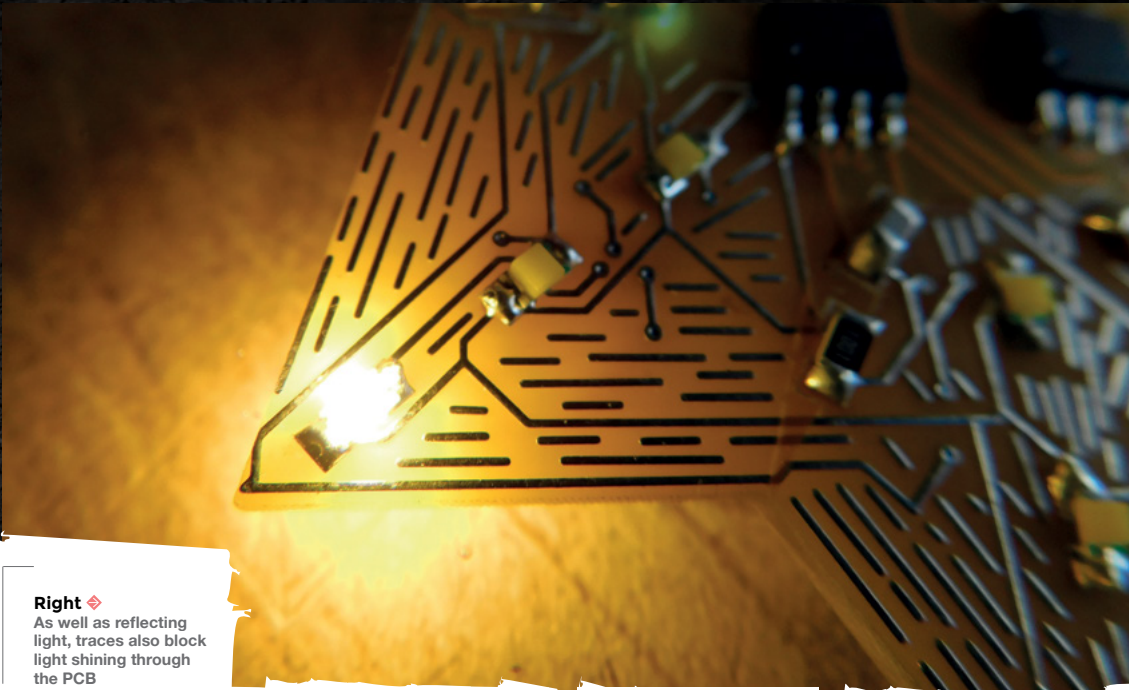
**Right** ♦ This Christmas PCB flashes the LEDs randomly on and off

**C**hristmas means different things to different people. Here in HackSpace towers, it means an excuse to play with LEDs. Lots of LEDs. In the past, we've used strings of addressable LEDs to adorn Christmas trees and other decorations, but this year, we decided to go a step further and get some PCBs made to show off the LEDs.

It offered the opportunity to experiment with different ways of driving LEDs, different types of LEDs, and different PCB effects we can create to make our PCBs artistic.

**We decided on three PCBs, each experimenting with a different thing:**

- A bell-shaped PCB with a large area of exposed copper to see how the shiny HASL (silver-coloured coating) looks in big areas. This has a single APA106 (through-hole NeoPixel) as an LED.
- A star-shaped PCB with individual white LEDs powered by a WS2811 chip (more on this later). We also used this to experiment with lines of silver HASL to reflect the light.
- A Christmas tree-shaped PCB with both individual LEDs and APA106s. We wanted to use this to experiment with artistic component placement.

**Right** ◆

As well as reflecting light, traces also block light shining through the PCB

Let's start at the first one – the bell-shaped PCB. When making a PCB, it goes through different stages to etch out the copper traces, drill holes, and add a (usually green) solder mask to protect the copper and make it easier to assemble. One of the final things is to dip the whole PCB in a vat of molten solder and then blow off any excess, leaving just a thin film of solder stuck to any previously exposed copper – this is known as hot air solder levelling (HASL). However, it's not the only treatment option. The alternative is electroless nickel immersion gold (ENIG), which gives a gold-coloured finish to exposed copper – this is significantly more expensive and out of our budget for novelty PCBs.

Given that the solder left behind by HASL reflects light, we thought we'd try to use this to make a shiny PCB that would reflect the light around it. The end result was disappointing. The HASL was soft and scratched easily (unsurprising in hindsight since solder is mostly tin, which is a soft metal). Instead of a shiny, smooth surface, we got an uneven matt surface. To make matters worse, we accidentally

used the wrong sized footprint for the capacitors we had. We did manage to get one PCB soldered up and working, but the results weren't good enough for us to pursue this further.

At the risk of spoiling the ending, things got better from here.

Experiment number two was a star-shaped PCB. You may well be familiar with WS2812B LEDs (aka NeoPixels) as we use these a lot in projects. They let you control an almost limitless number of RGB LEDs from a single pin. You might not know about WS2811 chips. This is basically the same driver that's in a WS2812B LED, but without the LEDs attached. Each WS2811 chip has three current-limited outputs to which you can attach LEDs, as well as a data in pin and a data out pin, which allow you to chain the chips together.

To recreate a WS2812B, you simply need to attach a red, green, and blue LED to each output in turn, and you'll be able to control them as you would any other NeoPixel. However, each LED doesn't have to be red, green, or blue. They can simply be three LEDs that you drive with 10mA (the driving current from WS2811). We used six white LEDs →

**We'd try  
to use this  
to make a  
shiny PCB**

## FEATURE

(three sets of two in parallel) – these formed each spur (with the pair being in the same place, but on each side of the PCB). Driving LEDs in parallel like this isn't really recommended because you can get problems if the LEDs aren't exactly the same, but we were in the mood for experimentation, so why not try it? It's worked well for us, but this is no guarantee that it will work well next time.

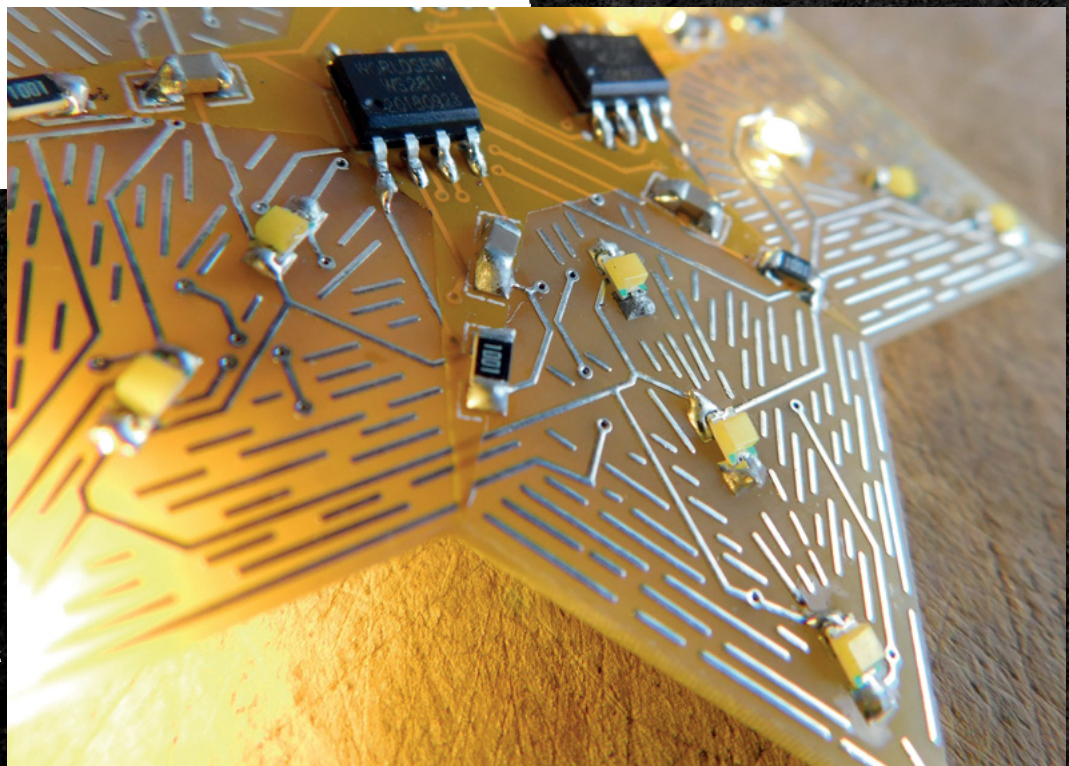
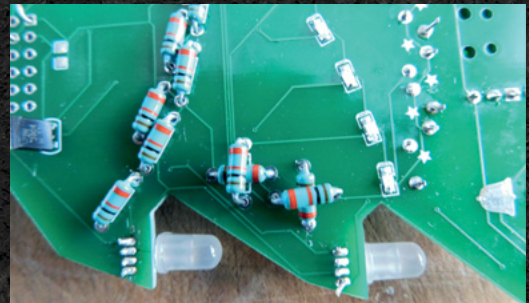
We used six WS2811 chips (three on each side of the PCB) for our six-pointed star. There's no microcontroller; this star is designed to be driven by an external microcontroller (and includes a data out pin from the last chip, so you can chain them together).

The circuit for the WS2811 chips and LEDs came straight out of the datasheet. It has a 1 K resistor between the 5V supply and VCC to prevent too much power flowing into it, and a 0.1 uF capacitor between VCC and GND on each chip to smooth the power supply. A 1 K resistor between DOUT of one chip and DIN of the next also help protect from any excess currents.

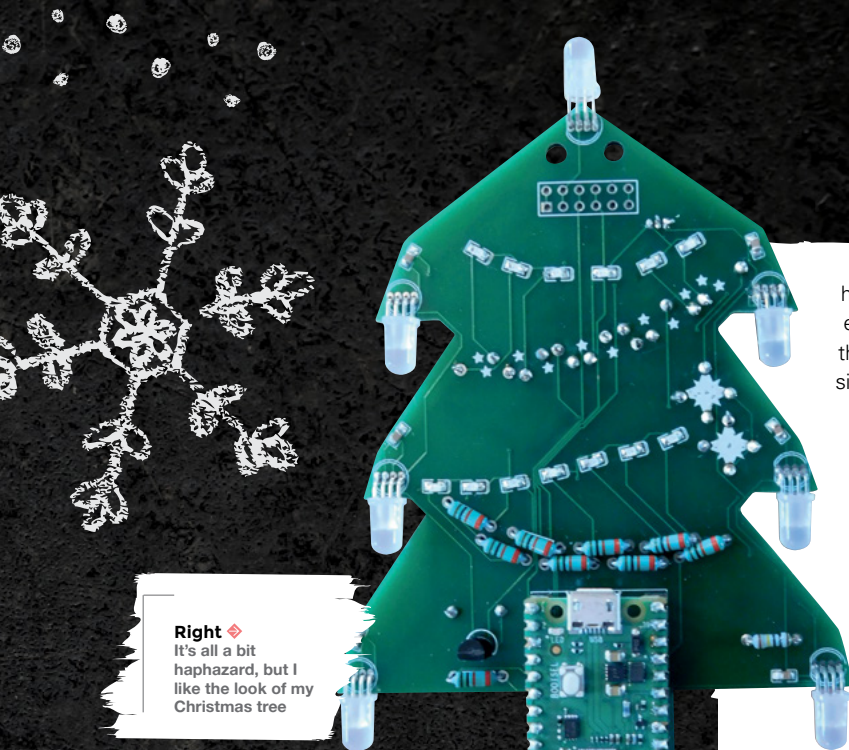
It's the first time I've used WS2811 chips, and I'm pleased with how they worked. They provide a PWM signal and current protection for the LEDs, so are


## Resistor crosses

When playing with the resistor placement on this, I had a few left over that I couldn't easily find space for. There was some open PCB, but I didn't just want to fill it. I decided to try making shapes with the resistors. After fiddling about with a few options, I created some crosses by placing one resistor over the top of another. Is it a good idea? Does it work visually? Honestly, I'm still not sure. It's one of those things that's so weird that you have to leave it for a little while and then come back to it before you know how you really feel about it. What do you think?



**Right** ♦  
These exposed traces really add to the look of the decoration



**Right**  It's all a bit haphazard, but I like the look of my Christmas tree

easier to use than port expanders or similar alternatives. They're available for just a few pence each, so are a cost-effective way of controlling a lot of LEDs.

You can drive the WS2811 chips using the usual NeoPixel library in Arduino or CircuitPython. These both refer to colours in their RGB form, but as long as you realise that these are just channels driving your LEDs, not actual colours, it's easy enough to use without modification.

I think the comparison of the bell and star PCBs is a good illustration of how to use exposed HASL for decoration effectively. On the bell, the large area ended up looking scuffed and unpleasant. However, the lots of little traces on the star give a really pleasing effect. This does come with a couple of caveats. Firstly, they're an absolute pain to solder. It turns out that solder mask does do a really good job of ensuring solder stays where it's supposed to and doesn't bridge connections. Removing it (we removed it from the whole area) means you have to be very careful when soldering. We could have been a bit more judicious with our solder mask design, but that brings us to the second problem – it takes ages to create. We had to put this all in by

hand and spent a long time making sure everything lined up as we couldn't use the grid (which didn't work with a six-sided shape).


There's a lot of exposed electrical connections on this, which does significantly increase the risk of short-circuiting it if it comes into contact with anything conductive. I haven't fully decided how to use these PCBs yet, so might investigate using something like conformal coating to make them safer when in use.

Overall, I'm really pleased with the star, and even more pleased to have two new tricks in my armoury for future projects: WS2811 chips and exposed HASL for artistic effect.

## GROWING A TREE


The final project was probably the most ambitious. It really started because I was looking at the different effects you get with different types of LED and was wondering about combining them. In this case, diffuse 5mm dome LEDs and small (0805) →



**Left**  Take a look at the Christmas tree animation at [hsmag.cc/xmastree](http://hsmag.cc/xmastree)

FEATURE



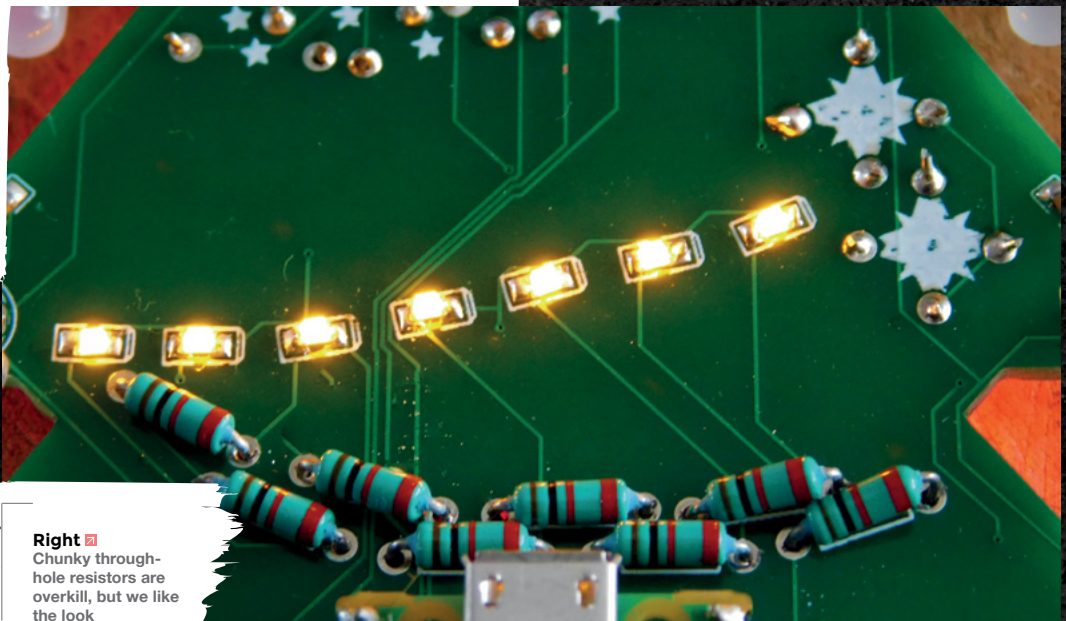
**Right**  Yes, I know the LEDs aren't lined up perfectly, but I was in a rush, OK!

surface-mount LEDs. One thing led to another, and I decided to make some Christmas trees with a Raspberry Pi Pico as the trunk and the components artfully arranged. As well as the LEDs, I needed a few additional components. There are some capacitors to smooth the power supply, resistors to limit the current to the LEDs, and a couple of transistors to allow me to control multiple LEDs from a single GPIO pin. These days there are lots of choices for the form-factor of components, but really it came down to one thing: did I want to hide the components away by choosing the smallest surface-mount components I could, or did I want to celebrate them by going with larger, through-hole components and placing them decoratively?

The former option would make the LEDs stand out more, but the latter would really let us celebrate the electronics components that we know and love. I went with a sort of hybrid approach in the end. I used through-hole resistors and transistors, but surface-mount capacitors. I attempted to place the resistors to look like tinsel. The effect is helped a little by the fact that I found some boxes of new old-stock resistors in a 'use me' pile in Bristol Hackspace. These older resistors are large, shiny, and look a bit more interesting than the usual ones I get.

This PCB was the hardest to get working. Mostly due to me being a bit of a fool. I designed all the PCBs in EasyEDA, which lets you search other people's footprints. I found one for APA106 LEDs

*I attempted to place the resistors to look like tinsel*



**Right**  Chunky through-hole resistors are overkill, but we like the look



## BadgeLife

I took a lot of inspiration in this piece from the conference badge movement. There's a long-running practice of using decorative or interesting PCBs as badges for electronics conferences – particularly DEF CON, but also others. If you search for the hashtag BadgeLife online, you'll see a lot of examples.

The documentary called BadgeLife by Sophi Kravitz of Hackaday is well worth a watch: [hsmag.cc/BadgeLife](http://hsmag.cc/BadgeLife).

The beauty of a Christmas decoration, rather than a conference badge, is that Christmas decorations are used every year – they're just added to each time.

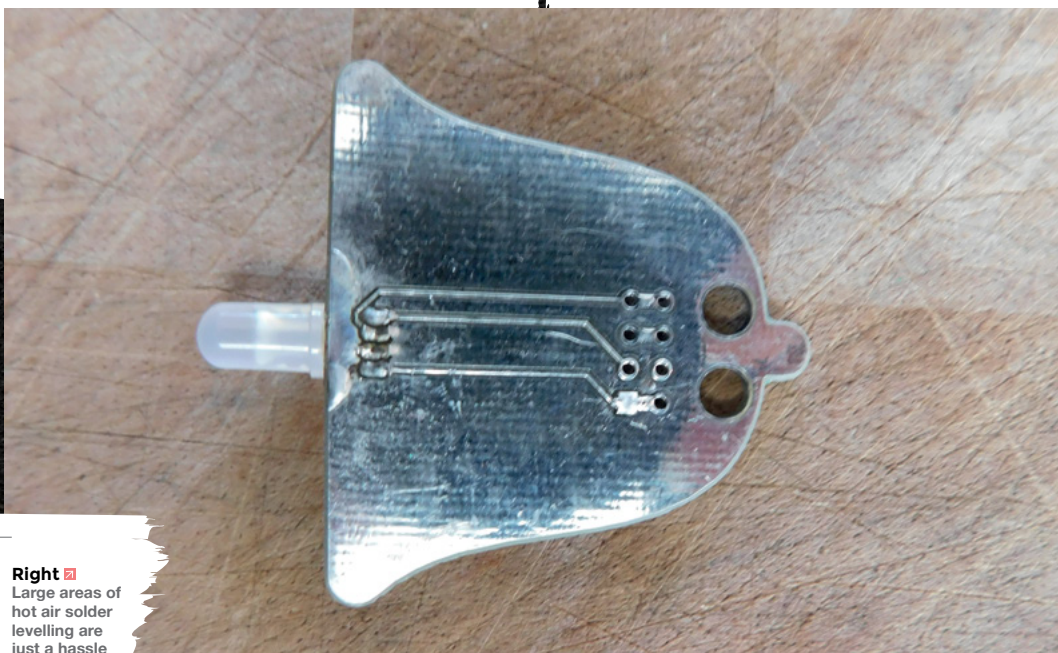
(the through-hole NeoPixels) and used them without checking fully that they were correct. They were not. They had power and ground flipped. I made a few other changes, including allowing more space for the Raspberry Pi Pico, and switched the footprints and waited for them to return. After soldering, I realised that I had somehow managed to make the same mistake again. To this day I don't know how I managed to make this mistake twice.

I fixed it all on the third revision of the PCB and now have four fully working Christmas tree PCBs. Again, I'm really pleased with the result – they're

more or less a physical form of what I had in my head. Whether or not you like them will probably very much depend on how you feel about PCBs and older-style components like dome LEDs and through-hole resistors. Personally, I really like them, but they might be something of a niche taste.

The header at the top includes two GPIO outputs to allow me to connect these up to other hardware. I imagine this will probably be to use these as part of longer rows of fairy lights, but I haven't yet decided. The two additional holes at the top are to let me put strain relief on the power cables using cable ties. I've not yet tested this.

Christmas obviously comes around every year, and like most households, we're gradually building up a stock of decorations. I've designed these PCBs to be expandable. On the Christmas tree, there are two GPIOs exposed, and on the star, there's Data Out to allow you to chain multiple PCBs together. Where I'll go with this next year, I'm not quite sure, but I've had great fun getting this far, so I'm sure there'll be something. □



**Right** □ Large areas of hot air solder levelling are just a hassle



The  
**MagPi**

**HackSpace**  
TECHNOLOGY IN YOUR HANDS

**CUSTOMPC**

**3 ISSUES FOR £10**



**FREE BOOK**



[hsmag.cc/hsbook](https://hsmag.cc/hsbook)

Subscribe to The MagPi, HackSpace magazine, or Custom PC. Your first three issues for £10, then our great value rolling subscription afterwards. Includes a free voucher for one of five fantastic books at [store.rpiexpress.com/collections/latest-bookazines](https://store.rpiexpress.com/collections/latest-bookazines)  
UK only. Free delivery on everything.



# FORGE

HACK | MAKE | BUILD | CREATE

Improve your skills, learn something new, or just have fun tinkering – we hope you enjoy these hand-picked projects

PG  
80

## PARALLEL NEOPIXELS

Power 26 chains of  
NeoPixels in one go

PG  
82

## SENSORS

Sniff out gases with a  
Raspberry Pi

PG  
86

## FREECAD

Ditch the 3D printer – learn  
to design for folded sheets

PG  
94

## VINYL CUTTING

Cut parts accurately and precisely



PG  
74

## SCHOOL OF MAKING

Start your journey to craftsmanship  
with these essential skills

74 Pico Gearbox



PG  
98

## TWINKLING LIGHTS

Our favourite Christmas  
lights code

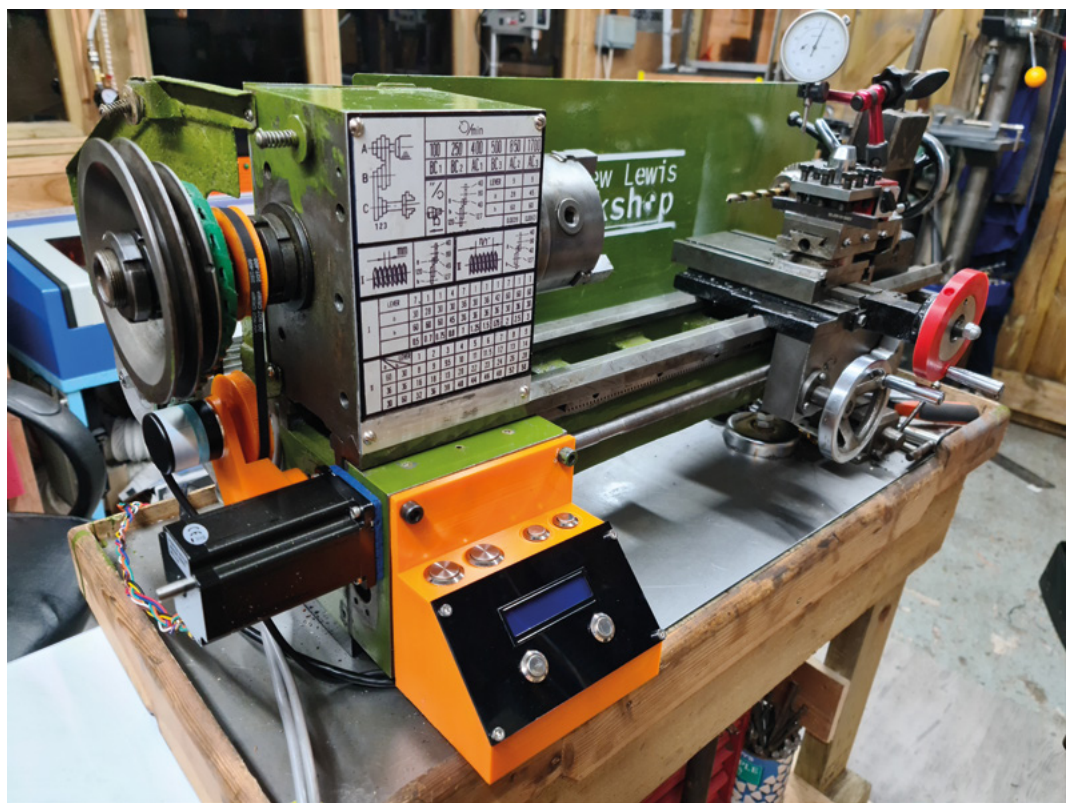
# Pico-powered electric gearbox

Running a lathe with a Raspberry Pi Pico



Dr Andrew Lewis

Dr Andrew Lewis is a specialist fabricator and maker, and is the owner of the Andrew Lewis Workshop.

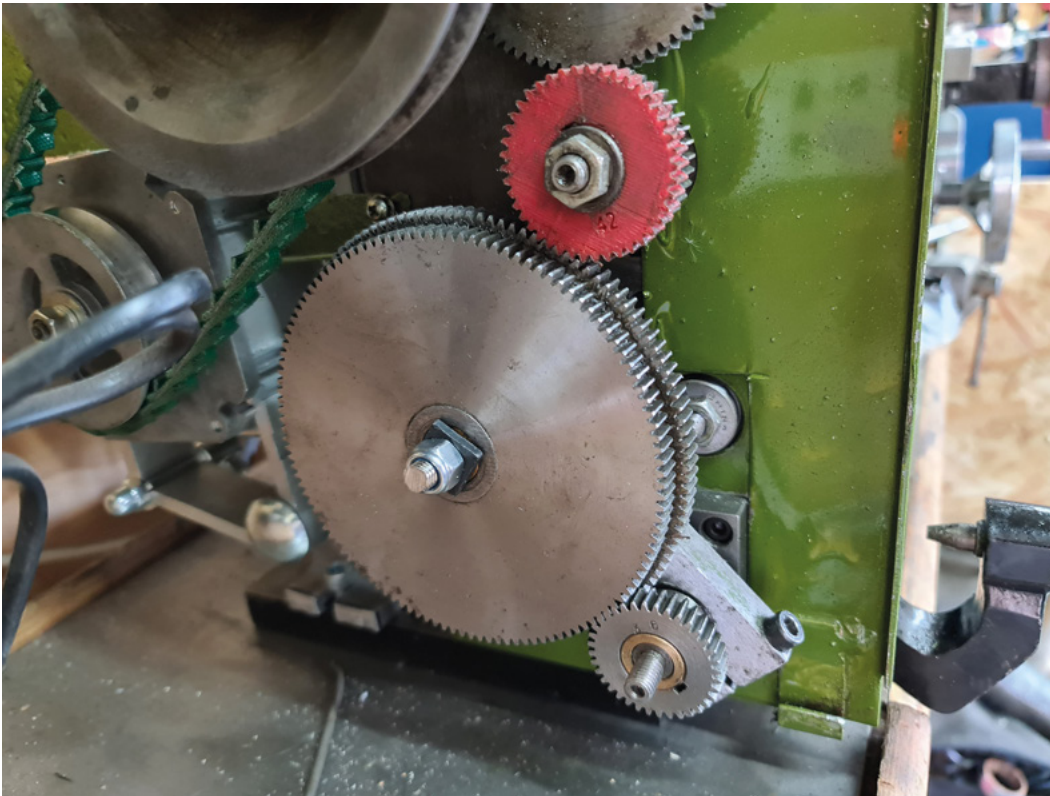


**Above**

This lathe now has an electric gearbox and a variable speed spindle motor, which makes the large, complicated table on the front of the machine entirely decorative. Without these upgrades, changing the feeds and speeds would mean grabbing a spanner and a screwdriver to reconfigure the gears

**T**his project is about building a gearbox for an old lathe that really should be retired from service. It's a lathe that has some sentimental value, and keeping it alive is not a commercially sensible decision. During a recent thread cutting operation, the lathe coughed, sputtered, and then fired a large steel gear out of the side of the machine, missing the owner's head by a couple of inches. Part of the gearbox had jammed, and had damaged the rest of the box beyond all reasonable chance of repair. What at first seemed like a disaster actually turned out to be a perfect chance for the Raspberry Pi Pico to shine.

Thread cutting on a hobby lathe can be time-consuming. Some lathes have a gearbox that lets you select a pitch from a range of common values, while others use change gears that need to be replaced whenever you want to cut a different pitch. Some lathes can only cut right-handed threads, while others have a tumbler reverse for cutting left-handed threads. It's not uncommon for the change gears to go missing from a lathe, or for the gear change diagram to be so complicated that some people just can't figure it out. An electric gearbox does away with all of this mechanical complexity, and lets the machine operator select feed rates and directions with the push of a button.



**Left** ◆  
This gear chain looks OK, but the spindle on the largest gear is cracked. The gear flexing on the shaft caused catastrophic damage to the lathe

**Below** ▣  
3D-printed jigs can really help you increase your accuracy when you're trying to get parts into alignment. This drilling jig locates the mounting holes for the motor relative to the centre of the hole for the original shaft bushing

The problem with commercial electric gearboxes is that they're pretty expensive. There are some open-source offerings, but they still have quite a significant cost associated with them because you need quite a fast processor to work at the sort of speeds needed to monitor and control a lathe. Electric gearboxes essentially replace the gears in a lathe with a tachometer, a microcontroller, and an electric motor. The tachometer measures the speed of the lathe spindle, and the microcontroller calculates and sets how many rotations per minute the lead-screw should turn to move the cross slide at a particular speed along the way of the lathe.

### GETTING LATHEY

You need to begin by removing the existing gears from the lathe gearbox, and then removing any superfluous gears from the head of the lathe. You need to create as much free space as you can in the head of the lathe, because you'll be fitting an optical encoder and a large stepper motor onto the side. How these parts will fit into the lathe will depend on the model you have. For the common 9x20 class lathes, you can fit a 3D-printed T2 pulley onto the spindle, and connect it to the encoder with a toothed belt. The stepper motor can be connected directly in line with the lead-screw using a steel rod, drilled at the ends to act as a coupling between the motor shaft and the lead-screw end. It can be tricky to line up the shafts exactly, but adding a

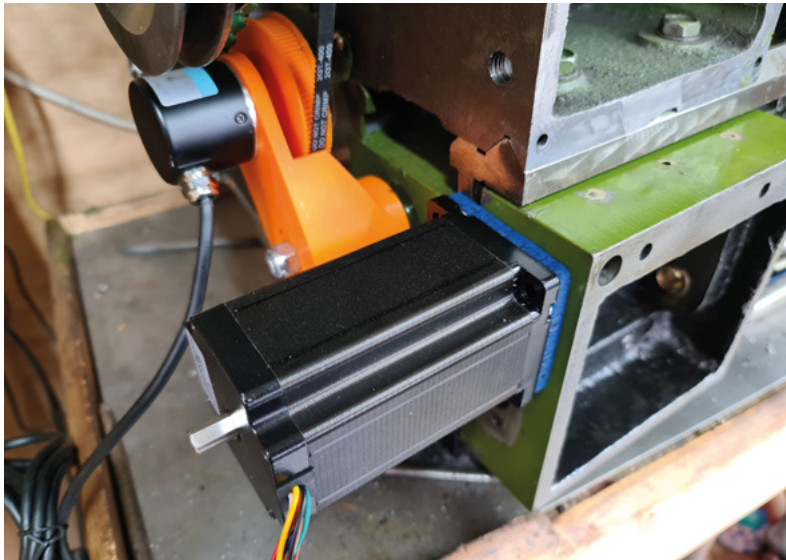
5mm cork gasket to the front of the motor and slightly oversizing the hole in the shaft at the lead-screw end, then filling the gap with silicone, will give you some wiggle room to align everything. The cork will also help to dampen any vibration noise from the motor.

Your stepper motor and controller will need 24V power, so it's best to add a box to the side of the lathe to keep these components in. You can also take this opportunity to add an emergency stop to the box, and reposition your motor controls if you've replaced the original spindle motor on the lathe. The Raspberry Pi Pico will need 5V power, and the quickest way to supply it is to add a 5V buck converter to the output of your 24V PSU to get the necessary 5V output. At this point, you should have an optical encoder attached to →



### YOU'LL NEED

- ◆ **A Raspberry Pi Pico**
- ◆ **24 V PSU**
- ◆ **DC-DC buck converter (5 V)**
- ◆ **6 × push-button switches, (ideally vandal and waterproof)**
- ◆ **1024-bit optical industrial rotary encoder**
- ◆ **2GT-400 timing belt**
- ◆ **DM556T motor controller**
- ◆ **NEMA 24 motor (4Nm 8wire)**
- ◆ **TXS0108E bidirectional level shifter (or similar)**



the spindle of your lathe, a large stepper motor attached to the lead-screw, and a box with power supplies and a motor controller somewhere sitting off at the side, looking a bit lonely. Next, you'll need to put together a control box with a display and some buttons, and connect all of the wires together using the circuit diagram. It's helpful if you can make it easy to disconnect your wires from the control panel. A good solution is to use aviation connectors on the motor and the control lines, as they're shielded and have screw fittings to hold the plugs in place. It's also wise to braid your motor cables to reduce the chance of interference, and to route the cables so that the

signal and power cables are as far apart as is practical. Ideally, shielded cable should be used, with the shield connected to earth points on the case and lathe body.

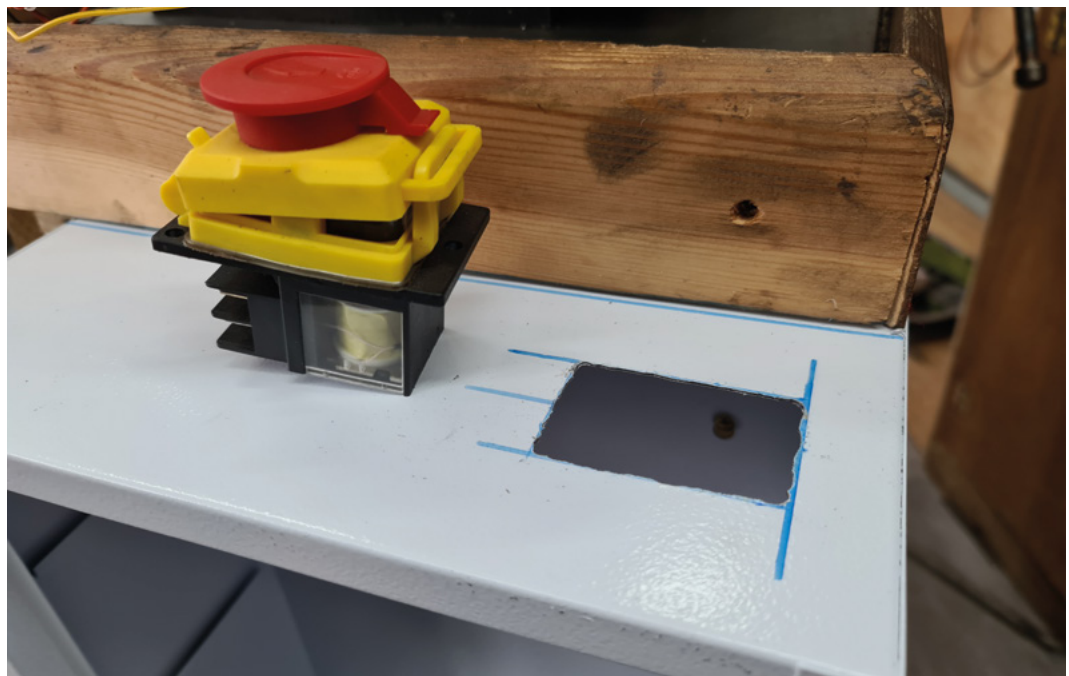
The Raspberry Pi Pico is the heart of the gearbox, and it does all of the necessary sampling and signalling to keep the spindle and lead-screw working in sync, while keeping the user informed via an I2C-connected multiline display. Let's look in more detail at what the Pico is actually doing (the code is online at [hsmag.cc/issue50](https://hsmag.cc/issue50)). The rotary encoder connected to the spindle is generating a series of signals that are supposed to indicate the direction and position of the encoder's shaft. It doesn't really matter which direction the shaft is moving in. We only really care about the speed that the shaft is moving. Rotating the spindle 360 degrees generates a total of 1024 pulses on both the A and B outputs of the encoder. The encoder uses two outputs to track the direction of the shaft. Because we only care about speed, we can use the Pico to count the pulses from just one of these outputs over a period, and use this to calculate the rpm of the spindle. To get the best measurements we can, we will use the PIO feature of the Pico to count the pulses from the encoder. The `PIO_COUNTER` function does this by keeping a tally of the pulses received in the X register, then using a timer to push out the tally to the ISR after a set amount of time. The timer also sets a flag true to let the main loop of the app know that the sampling period for the number of pulses has finished.

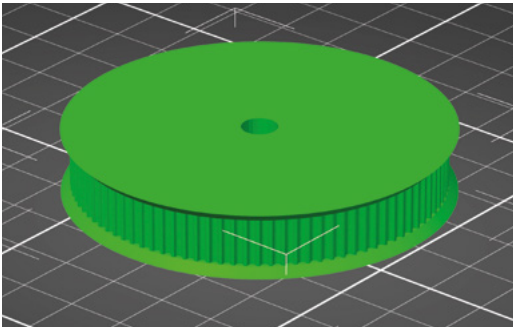
### Above

The cork gasket is one method of reducing vibration and adding a little bit of flexion to the drive system. Getting direct drives to align properly is a challenge, and the old adage about 'make it accurate or make it adjustable' is worth paying attention to

### Right

Cutting holes into a metal cabinet can be awkward. Using a metal nibbler to cut out the hole is fast and easy, and it makes very little mess

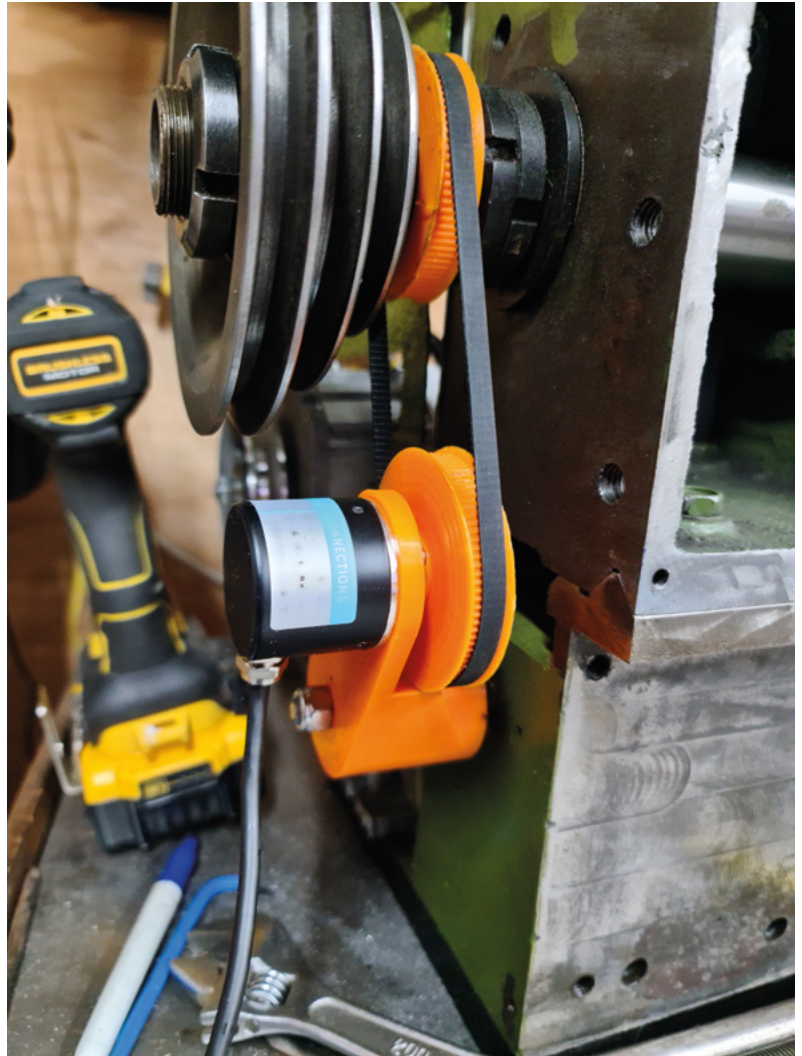




Now that the Pico can count the number of pulses per second, we need to do something useful with that count. First, we want to convert the number of pulses into a number that the user can understand, and display it on the 1602 LCD.

The LCD is connected to the Pico on pins 0 and 1, with power being provided from the VBUS pin. Access to the display is provided by **lcd\_api.py** and **pico\_i2c\_lcd.py**, which you should install on your Pico from **hsmag.cc/PythonLCD**. For more information on how to install this, follow Les Pounder's instructions at **hsmag.cc/LCDDisplayPico**. Most I2C LCD modules use the address 0x27, although with only one item on the I2C bus, you don't need to worry about this and can simply use the command `i2c.scan()[0]` to find the address of the first detected item. We calculate the rpm of the shaft from the number of pulses per sample period, and then display it to the LCD using the `lcd.putstr()` command.

With a known rpm, we can calculate the speed that the motor should be running at to create a thread of a particular pitch, and get the stepper motor running at that speed. To do that, we will use another one of the Raspberry Pi Pico's state machines to send instructions to the stepper motor controller. The DM556T motor controller used in this project is very similar to the A4988 or DRV8825 controller that you find in a 3D printer. While the A4988 is designed to handle smaller motors like the NEMA 17, the DM556T can handle the power requirements of more powerful motors like the



4A NEMA 24 used in this project. The inputs of the DM556T are more flexible than those on the A4988, accepting a range of voltages between 5–24V on the three motor pulse, direction, and enable pins. The inputs also accept both positive and negative connections for each input, which can be useful to filter out electromagnetic interference caused by high-power motors and other sources.

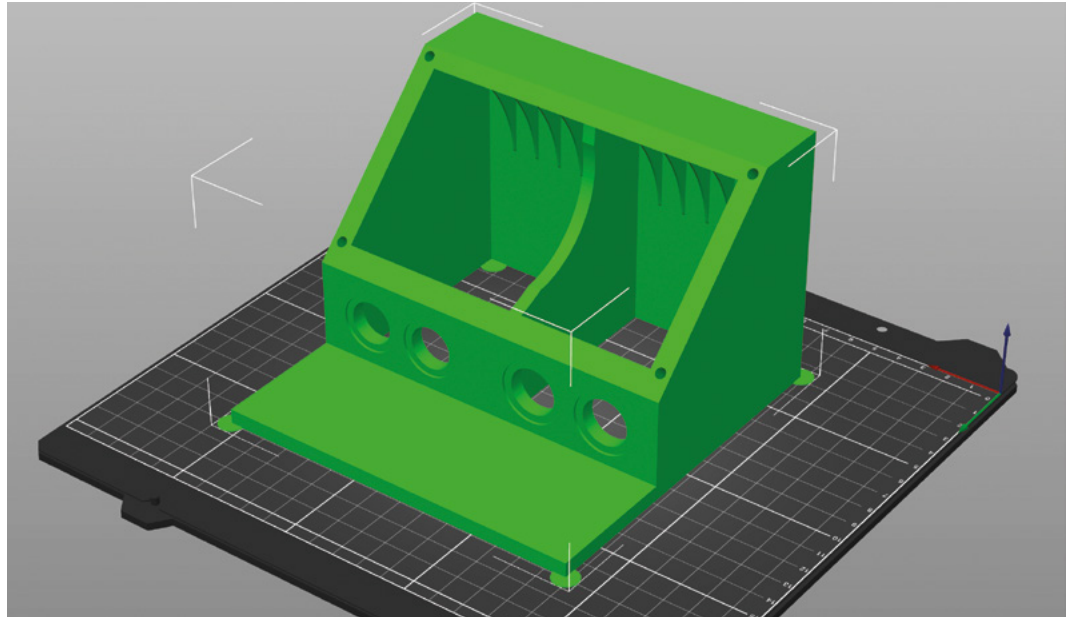
You can use a very simple piece of PIO code to turn one of the Pico's pins into a square wave generator. One instruction will be used to turn the pin on, and one instruction will turn the pin back off again. This regular pulse will be the signal sent to the motor controller to advance the shaft by one step. With the DM556T set to microstep the motor at 1000 steps per revolution, this will rotate the motor at 60 rpm when the state →

## LEVEL SHIFTER

The Raspberry Pi Pico uses 3.3V, but most motor controllers like DM556T need a minimum of 5V to function. You'll need to use a level shifter to bump that 3.3V up to the required 5V. The TXS0108E is a bidirectional level shifter that will take care of this for you, but you'll need to take care with where you position the module. The TXS0108E is designed for logic-shifting signals between chips on the same board, and not for long runs of cable. For this project, it's best to locate the chip close to the DM556T motor controller, so that the distance between the boosted signal and the received signal is kept to a minimum.

**Left** 3D printing is a quick way of making custom gears

**Above** Industrial rotary encoders are not the same as the small encoders you use as a jog or volume control. Industrial encoders are normally optical or magnetic rather than mechanical, and don't usually need debouncing



**Right** ♦  
The housing has holes for buttons and space for a laser cut sheet

machine is started with a clock speed of 2kHz. The 2kHz frequency might at first seem to be double the number you'd expect, but you need to remember that the state machine needs to execute two instructions to pulse the pin on and off, so you need to allow one clock cycle per instruction. To get a minimum speed lower than 60rpm, you can add some extra `nop()` commands or tag some `wait [1]` commands to the end of each instruction, and allow for the extra instructions while calculating the target rpm, as shown in the `setRPM` function.

You'll need to connect some buttons to your control box so that you can set the target rpm of the lead-screw, and perform various other functions like changing the direction of rotation or stopping the carriage. The Pico has built-in pull-up resistors, so you won't need to add resistors to your push-buttons,

and although it's not great practice to debounce your switches in software by adding a delay, for this application it's not really a problem.

With the Pico loaded up with the example code, you should have all of the basic parts needed to get your lathe carriage moving. Before you plug the power cable in, there are some settings you need to check over. First, measure the number of teeth per inch that your lead-screw has. This value is critical for getting the right pitch on any threads you cut, so get hold of a screw gauge, and measure it properly. Most lead-screws are imperial and measure in at 16TPI, but it's possible you've got a different TPI, or even a metric value depending on your lathe. Check the value, and adjust the `shaftTPI` variable to match it.

### RIGHTY TIGHTY, LEFTY EXPLODEY

You'll also need to adjust the DIP switch settings on the DM556T to match your motor and stepping preferences. 1000 steps per revolution is a good place to start, and it's also wise to start out with the motor current set lower than your motor's rated current. This will help make sure that the motor doesn't overheat or get damaged if something goes mechanically wrong. If your motor stalls, you can always check for mechanical reasons first and increase the current rating later. The same principle applies to the motor's holding current. One of the DIP switches reduces the holding current to 50% of maximum. If you find this isn't enough, flip the switch – but keep an eye on the motor temperature until you're sure nothing is going to overheat.

### HOW MANY WIRES?

The DM556T is designed to work with a four-wire bipolar stepper motor. However, you may find that your stepper motor has either six or eight wires connected. For a six-wire motor, you'll just need to use four of the wires and leave the 'centre taps' disconnected. For an eight-wire motor, you'll connect the wires together so that the coils are either connected in series or parallel. Wiring the coils in parallel will maintain torque at higher speeds, while series wound motors will have a better holding torque and less torque at high rpm. For this project, the coils are probably better wired in parallel.

### QUICK TIP

Power wires and control signals don't mix well. Route your cables carefully, and use shielded, twisted pair cables to avoid interference problems.



Finally, raise the half-nut lever on the lathe carriage so that the lead-screw and carriage move independently. Check the lathe is in a safe condition, and power it on at a low speed. Press one of the direction buttons on your control panel, and the lead-screw should start to turn. Check that everything is turning correctly, and the motor isn't making any strange noises or obviously slipping. If the motor doesn't turn, check that the spindle rpms are higher than the minimum required to run the crossfeed (set at 30rpm in the example code, but can be changed by adjusting the square wave PIO to accommodate lower speeds). If the motor still isn't moving, make sure that the level shifter is wired correctly, with the OE pin soldered to the 3.3V line, and that the pulse and direction pins are properly connected. If you still can't get the motor to run, double-check the coil wirings (remember that an eight-wire motor with parallel connections should have the opposite coils wired with reverse polarity, or the two coils will cancel each other out) and make sure you've got a pulse signal coming from the Pico using an oscilloscope if you can. Once you're happy that the motor is working as expected in both directions, increase the spindle speed and check that the lead-screw still looks stable. Finally, reduce the spindle



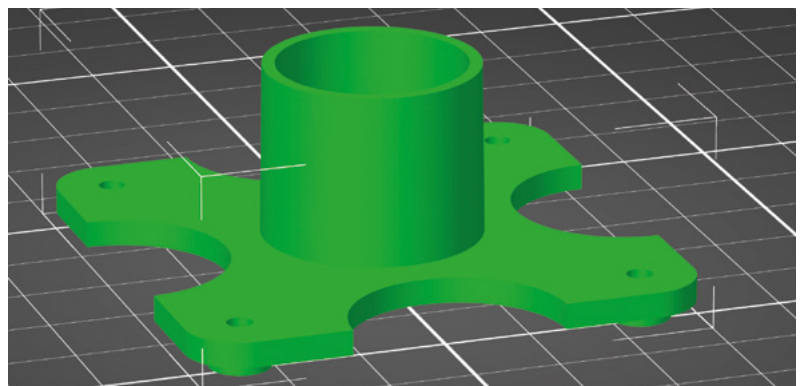
**If the motor still isn't moving, make sure that the level shifter is wired correctly**



speed, and carefully engage the half-nut to interlock the carriage with the lead-screw. If all goes well, the carriage should start to move. If you find your motor starts to skip, you might need to increase the motor power or change settings on the DM556T. With a little work, you should be able to dial in the electric gearbox to match the configuration of your lathe, and even add extra functionality to rapid move the carriage or monitor the direction of the spindle. If you feel particularly ambitious, you could add more CNC-like operations to the lathe with extra motors and DRO sensors. □

**Above** ■ Make sure that you get the right sort of 1620 I2C display to use with the Raspberry Pi Pico. Some are 5V only and might damage the Pico, some use 5V power but 3.3V logic, and some are entirely 3.3V. It's not always clear which sort of display you have in your hand unless you have the original packaging with the description

**Below** ◆ Get the STL files and code from [hsmag.cc/issue50](https://hsmag.cc/issue50)



# All the LEDs

Power up to 26 strips of NeoPixels from a single Raspberry Pi Pico



Ben Everard

@ben\_everard

Ben's house is slowly being taken over by 3D printers. He plans to solve this by printing an extension, once he gets enough printers.

**Above** NeoPixel strips are probably the most common form of addressable LEDs

# W

**S2812B LEDs – sometimes known as NeoPixels – are a great way of adding colour to your project.** They're chainable RGB LEDs, which means that you can connect lots of them

to a single GPIO pin on a microcontroller. If you're adding a few tens of LEDs, this works really well. However, if you try to chain together too many, you get a few problems, including slow updates and the potential for one broken LED to stop your entire project working.

However, even if you have spare GPIO pins, it's not always possible to connect NeoPixels to additional GPIO pins. These LEDs speak a slightly unusual protocol, and it can be resource-intensive to send data out.

Fortunately, Pico has a trick up its sleeve. Its Programmable IO (PIO) lets you create state machines that can send data to external devices using almost any protocol with very little CPU overhead. You can send data to NeoPixels using state

machines. Pico has eight state machines available, so you can send data to NeoPixels from eight GPIO pins. This is a bit better than just one, but what if we want to blaze all the lights. We have 26 GPIO pins; why can't we connect a NeoPixel to each one?

Well, we can! Graham Sanderson – one of the team of software engineers working on the PicoSDK – created a PIO program that can control strings of NeoPixels. We have adapted it slightly to make it easier to understand. If you just want to make LEDs flash, you can grab the code using this link:

[hsmag.cc/PicoParallel](https://hsmag.cc/PicoParallel).

The PIO program is deceptively simple:

```
.wrap_target
out x, 32
mov pins, !null [T1-1]
mov pins, x [T2-1]
mov pins, null [T3-2]
.wrap
```

The protocol is basically a continuous series of pulses. A short high followed by a longer low is a



digital 0, while a long high followed by a short 0 is a logical 1.

It reads in 32 bits of data and then sends them to the GPIO pins. Each 32-bit word of data we send to this PIO program contains 1 bit of data for each of the chains of NeoPixels. Data is handled in 32-bit registers, so it's not possible to make this an arbitrary number. It's possible to set it to be some factor of 32 (such as 16), but this will affect the way data is stored.

The main code has to now create and manage a structure that can be used to send data in this form.

```
uint32_t pixels[NUM_PIXELS*24];

uint32_t set_pixel_colour(int pixel, int channel,
uint8_t r, uint8_t g, uint8_t b) {
    uint32_t colour_value = (b << 16 | r << 8 | g);

    for(int i=0; i<24;i++) {
        if (colour_value & (1u<<i)) {
            pixels[(pixel*24) + i] |= 1u <<
(channel);
        }
        else {
            pixels[(pixel*24) + i]
&= ~(1u<<channel);
        }
    }
}
```

Here, we have a global variable called **pixels** that is an array 24 times the number of pixels (each pixel has 24 bits of data – eight each for red, green, and blue).

To set the colour value in this array, you have to loop through all 24 bits of the colour, and use bit-masks to set the right bit in each 32-bit value. This is done using either:

```
pixels[(pixel*24) + i] |= 1u << (channel);
```

...to set a bit high while leaving the other 31 bits unchanged, or

```
pixels[(pixel*24) + i] &= ~(1u<<channel);
```

...to set it low.

The **|=** and **&=** are used to OR or AND (respectively) the left-hand value with the right-hand value to apply the mask.

We need to fire out a lot of data. We could use the CPU to load data into the PIO state machine, but it would take a lot of the CPU's time, and we can free this up by using Direct Memory Access (DMA). This is an off-CPU system that will shuttle data from one

location to another – in our case, the **pixels** array to the PIO's transmit state machine.

There's a bit of code to set this up (and make sure the relevant interrupts are firing), but the main code to keep it running is:

```
int64_t dma_start() {
    dma_channel_set_read_addr(dma_chan,
pixels, true);
    return 0;
}

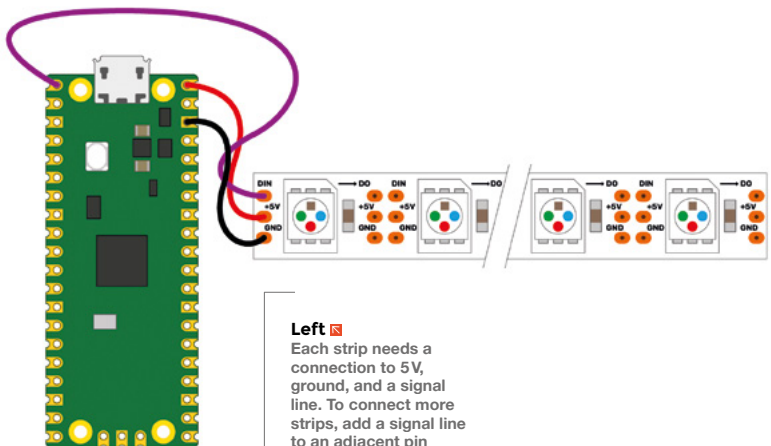
void dma_handler() {
    dma_irqn_acknowledge_channel(DMA_
IRQ_0,dma_chan);

    add_alarm_in_us(RESET_TIME_US, dma_start,
NULL, false);
}
```

Each time it gets to the end of the array, the DMA system raises an interrupt which is caught by **dma\_handler** (see the main code to see how this is set up). We need to pause for 400 microseconds to reset the LED strip before sending more data. You can't use sleep in interrupt handlers (or the program will crash), so we use an alarm to call another function at the appropriate time. The second function (**dma\_start()**) just kicks off the DMA transfer again. These two functions will just keep shuffling the latest data out to the LEDs with almost no CPU resources used.

In the main loop, you can set the pixels to be whatever colour you want, and this DMA/PIO system will update the LEDs as soon as possible.

This is an incredibly powerful way of controlling large numbers of LEDs in a way that's quick and has some redundancy should the hardware in a single LED fail. □



# Sensory world: Build a fire and gas leak alarm system



**Phil King**

Longtime contributor to *The MagPi*, Phil is a freelance writer and editor with a focus on technology.

@philkingeditor

Enable Raspberry Pi to detect flames and gas leaks to raise an alarm

**H**umans experience the world through a range of senses. This enables us to be aware of whatever's happening in our environment so that we can react to it.

So, it makes sense (no pun intended) that your Raspberry Pi would also benefit from being able to sense things. Fortunately, this is made possible using a wide variety of electronic sensors. In this series, we'll explore some of the most commonly available sensors and their use cases.

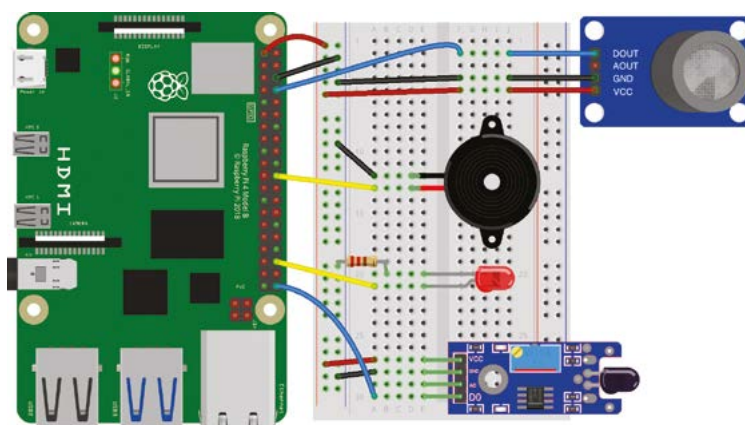
To start off, we'll build a simple fire and gas leak alarm system using a couple of sensors. When either hazard is detected, a visual and audible alert will be triggered.

## 01 Connect flame sensor

For this tutorial, we're using the flame sensor from the Waveshare Sensors Pack, available in the UK from The Pi Hut ([magpi.cc/wavesensors](http://magpi.cc/wavesensors)), and also sold separately, but any similar sensor should work in a similar way. It uses PIR (passive infrared) to detect a change in temperature nearby. While the sensor has pins for both analogue and digital outputs, we only need the latter for our alarm, as a nearby flame will set the digital output to high.

With the power turned off, connect the flame sensor to Raspberry Pi, as in **Figure 1** (where it's at the bottom). We're powering it from Raspberry Pi's 3V3 pin, grounding it with a GND pin (both via the breadboard side rails), and the digital output (marked DOUT on the sensor) is going to GPIO 21.

▼ **Figure 1** The wiring diagram for the complete alarm system, including two sensors, LED, and buzzer

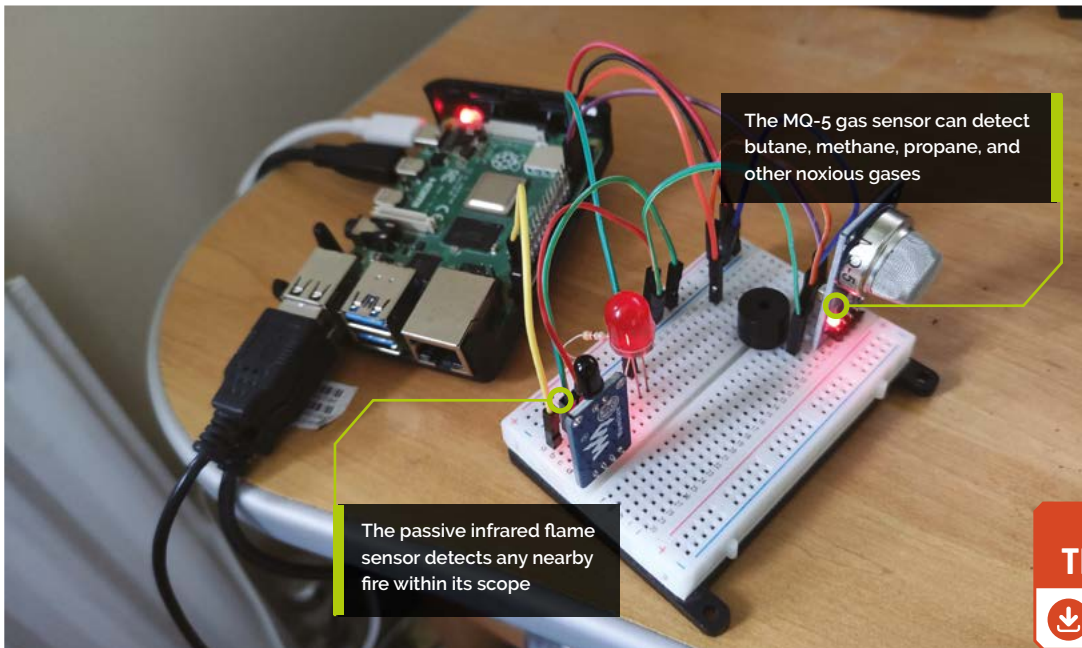


## 02 Flame test code

With the flame sensor wired up, turn on Raspberry Pi. You should see the sensor's red power LED light up if it's connected correctly.

To start with, we'll create a simple Python program, as in the `flame_test.py` listing, to read the sensor and print out a message when triggered, to check that it's working correctly. From the desktop menu, go to Programming and open the Thonny IDE to start coding.

To simplify the setup, we're using the GPIO Zero library rather than `RPi.GPIO`; at the top of



**DOWNLOAD  
THE FULL CODE:**



[magpi.cc/github](https://magpi.cc/github)

our code, we import the `Button` method from it. We'll use this to sense when the digital output from the sensor is high, in effect the equivalent of a push-button being pressed. As it's connected to GPIO 21, we assign the `flame` object to this with `flame = Button(21)`.

In an infinite `while True:` loop, we check whether the pin is high (`if flame.value == 1`) and set the message (`msg1` variable) that we'll be printing to the Thonny Shell area accordingly. In our print statement, we add the `end = "\n"` parameter so that the message is always printed on the same line, which is a lot neater than using a new line each time.

### 03 Flame on!

Now it's time to test our sensor by putting a flame near to it to see if it triggers our alarm message. We used a disposable lighter for this, but you could just light a match. Always be careful with fire, though, and don't get the flame right next to the sensor as it's not fire-proof!

Run your `flame_test.py` Python code and then move the flame towards the sensor. Ours triggered at around 30cm distance, but the sensitivity can be altered by using a small crosshead screwdriver to adjust the screw on the sensor board – other flame sensors may have a potentiometer rotary knob on board for this purpose.

When the flame is close enough to trigger the sensor, another red LED lights on ours to indicate this. The message printed in the Thonny Shell area should change from 'No fire' to 'Fire!'.

## flame\_test.py

► Language: **Python**

```
001. from gpiozero import Button
002.
003. flame = Button(21)
004. msg1 = ""
005.
006. while True:
007.     if flame.value == 1:
008.         msg1 = "Fire! "
009.     else:
010.         msg1 = "No fire"
011.     print(msg1, end = "\n")
```

### 04 Add a gas sensor

So, we have our flame sensor working correctly. Now it's time to add the gas sensor to our setup. We're using a Waveshare MQ-5 sensor for this, as featured in the Sensors Pack, but other similar gas sensors are available. The tin oxide layer inside the sensor has a high sensitivity to the presence of gases such as butane, methane, and propane.

The sensor has pins for analogue and digital outputs, but we only need the digital output for our alarm. We connect that pin (DOUT) to GPIO14, and the VCC and GNC pins to 3V3 and GND (shared with the flame sensor via the breadboard side rails), as in **Figure 1** (gas sensor at the top). →

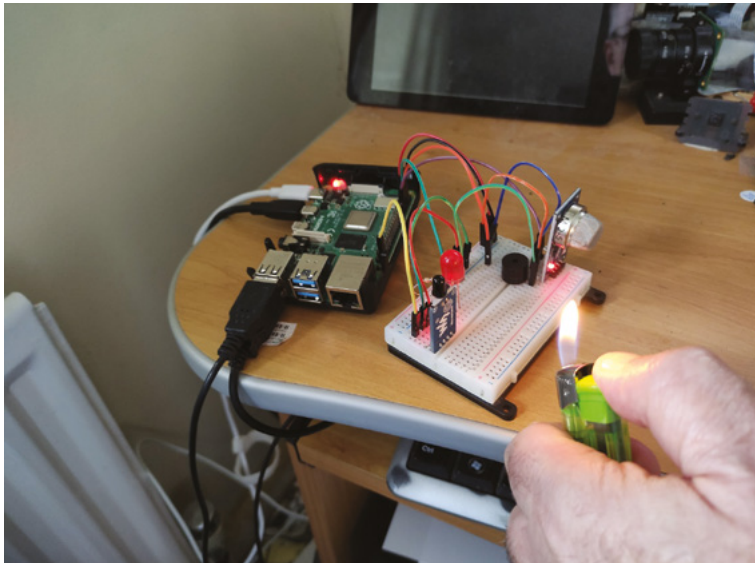
## Top Tip

### Analogue out

For simplicity, we've used the digital outputs to trigger our alarm. To use the analogue outputs, you'll need to add an ADC chip (e.g. MCP3008) to convert them to digital readings.

### You'll Need

- Flame sensor [magpi.cc/flamesensor](https://magpi.cc/flamesensor)
- MQ-5 gas sensor [magpi.cc/gassensor](https://magpi.cc/gassensor)
- LED
- Active piezo buzzer
- Jumper wires



▲ Testing the flame sensor with a lighter. Be careful not to move it too near the sensor or other components!

### Top Tip

#### Off board

We've placed our sensors on the breadboard, but you could keep them separate from the other components and wire them up from there, with the digital outputs wired directly to the GPIO pins.

## flame\_gas\_test.py

► Language: Python

```
001. from gpiozero import Button
002.
003. flame = Button(21)
004. gas = Button(14)
005. msg1 = ""
006. msg2 = ""
007.
008. while True:
009.     if flame.value == 1:
010.         msg1 = "Fire! "
011.     else:
012.         msg1 = "No fire "
013.     if gas.value == 1:
014.         msg2 = "Gas leak!"
015.     else:
016.         msg2 = "No gas "
017.     print(msg1, msg2, end = "\r")
```

### 05 Add gas to code

While we could create a new program to test the gas sensor separately, we'll add it in to our previous code as it will then be simpler to rework it into our final alarm code later.

In the `flame_gas_test.py` listing, we assign the gas object to GPIO18 with `gas = Button(14)`. As before, we're using the `Button` method to detect when the pin is triggered and thus set to high.

We add a new `msg2` variable, which we'll set to the message we want to print in the Shell area. This is done by adding some extra lines to our `while True:` loop. If the gas sensor pin is triggered (`if`

`gas.value == 1`), then the message will be set to 'Gas leak!'; if not, it'll be 'No gas'.

We add `msg2` to our print statement, after `msg1`, again including the parameter `end = "\r"` so the message is always printed on the same line.

### 06 Turn on the gas

Now it's time to test our gas sensor to check it's wired up and working correctly. As before, we're using a disposable lighter for this, pressing the button to release a little gas without igniting it for the flame. You could use gas from a hob or cylinder, but you only need a tiny amount to trigger the sensor, so be sure to turn it off again after a couple of seconds.

Run your `flame_gas_test.py` Python code and then release a little gas in the vicinity of the sensor. As with the flame sensor, the gas sensor's sensitivity can be altered by using a small crosshead screwdriver to adjust the potentiometer screw on the sensor board.

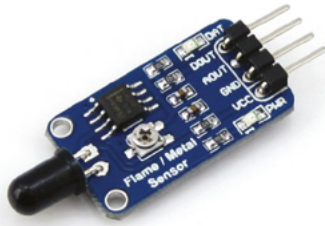
When the presence of gas is detected and the sensor is triggered, another red LED lights on ours to indicate this. The second message printed in the Thonny Shell area should change from 'No gas' to 'Gas leak!'.

## “ The gas sensor's sensitivity can be altered ”

### 07 Let there be light

If your sensors and code are working correctly, and the correct messages are shown when they're triggered, it's time to move on to the next part. Printed messages are all very well, but for a proper alarm you need a visual and/or audible alert.

For the visual side, we'll add a standard red LED to our setup – ours is 5 mm, but you can use any size. As always when using LEDs, a resistor is required to limit the current to make sure it doesn't receive too much and potentially burn out. With the LED placed in the breadboard, with legs in different unconnected rows, we connect a 330Ω resistor between the negative (shorter) leg and the ground rail of the breadboard. The positive (bent, longer) leg is connected to GPIO16 on Raspberry Pi (as in the **Figure 1** wiring diagram).



▲ The Waveshare flame sensor has both analogue and digital outputs. Sensitivity can be adjusted with the screw



▲ The MQ-5 gas sensor can detect several noxious gases in the air and is highly sensitive

## 08 Get a buzz

For our audible alert, we're using a small active piezo buzzer to make a beeping noise. The buzzer will have a longer positive leg and a shorter negative one; their positions may also be marked on top of the buzzer itself. Connect the negative pin to the breadboard's ground rail and the positive pin to GPIO 25 (as in **Figure 1**).

## 09 Alarm code

With everything wired up as per **Figure 1**, you're now ready to program your fire and gas alarm. In the final code, **fire\_gas\_alarm.py**, we add LED and Buzzer to the gpiozero imports at the top. We also import sleep from the time library, to use as a delay.

We create two functions, one for each type of alarm: **fire\_alarm** and **gas\_alarm**. Each uses a **for** loop which toggles the LED and buzzer on and off a set number of times, with a 0.5 sleep delay each time.

Finally, in a **while True:** loop, we check the pin values and trigger the relevant alarm when the pin receives a signal from the sensor. If neither is triggered, we show the default message and ensure the LED and buzzer are turned off.

## 10 Sound the alarm

Now to test the alarm system. As before, try positioning a flame near the fire sensor to check that the alarm is triggered, in which case the LED will blink and the buzzer will beep. Do the same for the gas sensor by releasing a small amount of gas; the alarm will sound again. Each time, an appropriate message will show in the Shell area.

## Taking it further

We now have a simple working fire and gas alarm. To make the alert more obvious, you could add a relay switch to turn on a 12V tower light with

buzzer (e.g. [magpi.cc/towerlight](http://magpi.cc/towerlight)). You could also send an email or push notification alert to your phone whenever the alarm is triggered.

Next time we'll create an intruder alarm using noise and laser sensors. See you then. □



**Warning!**  
Fire and gas

Never play with fire! Be careful when testing your alarm and don't position the lighter flame too close to the sensors or other components. Only release a small amount of gas and do it in a well-ventilated area. Do not rely on this DIY alarm for your safety. In the event of a real fire or gas leak, call the relevant emergency service.

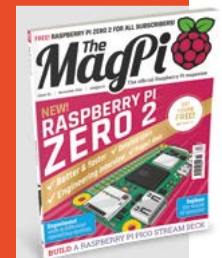
[magpi.cc/firesafety](http://magpi.cc/firesafety)  
[magpi.cc/gassafety](http://magpi.cc/gassafety)

## fire\_gas\_alarm.py

► Language: Python

```
001. from gpiozero import Button, LED, Buzzer
002. from time import sleep
003.
004. flame = Button(21)
005. gas = Button(14)
006. led = LED(16)
007. buzzer = Buzzer(25)
008.
009. def fire_alarm():
010.     print("Fire! ", end = "\r")
011.     for i in range (10):
012.         led.toggle()
013.         buzzer.toggle()
014.         sleep(0.5)
015.
016. def gas_alarm():
017.     print("Gas leak!", end = "\r")
018.     for i in range (10):
019.         led.toggle()
020.         buzzer.toggle()
021.         sleep(0.5)
022.
023. while True:
024.     if flame.value == 1:
025.         fire_alarm()
026.     elif gas.value == 1:
027.         gas_alarm()
028.     else:
029.         print ("All OK ", end = "\r")
030.         led.off()
031.         buzzer.off()
```

## THE MAGPI



This tutorial is from in The MagPi, the official Raspberry Pi magazine. Each issue includes a huge variety of projects, tutorials, tips and tricks to help you get the most out of your Raspberry Pi. Find out more at [magpi.cc](http://magpi.cc)

# Sheet folding in FreeCAD

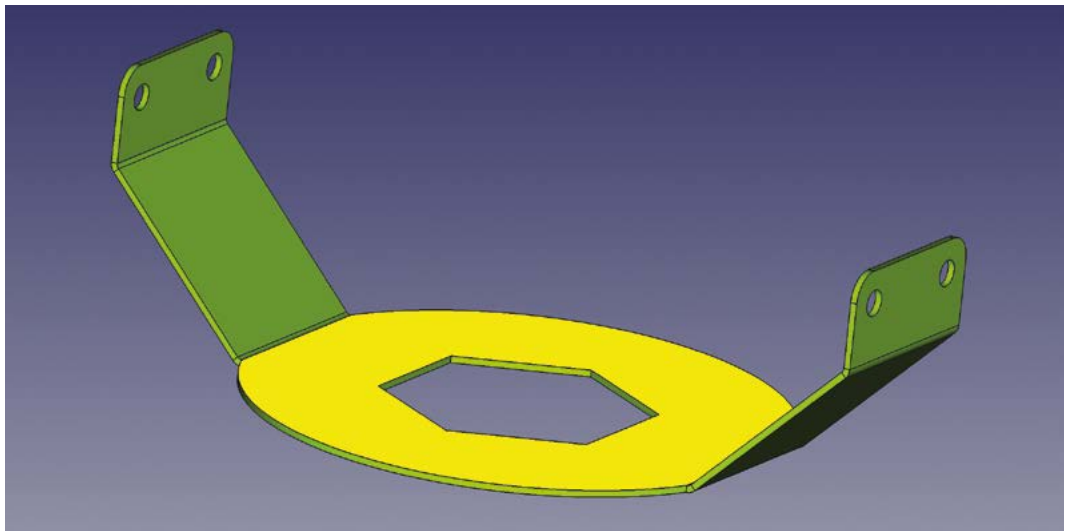
Let's look at an amazing workbench that makes working with sheet metals, or other foldable sheet materials, simple to CAD



Jo Hinchliffe

@concreted0g

Jo Hinchliffe is a constant tinkerer and is passionate about all things DIY. He loves designing and scratch-building both model and high-power rockets, and releases the designs and components as open-source. He also has a shed full of lathes and milling machines and CNC kit!



**In this issue, we are going to work mostly on an add-on workbench called 'Sheet Metal', so let's get that installed.** Open up FreeCAD and click Tools > Addon manager, and then scroll down the list to find 'Sheet Metal'. Click to install the workbench, and then close the Addon manager – you will get prompted to restart FreeCAD.

Once you have restarted FreeCAD, start a new project and, as a very simple first example, let's first go to the Part Design workbench, create a body, and then create a sketch in the XY plane.

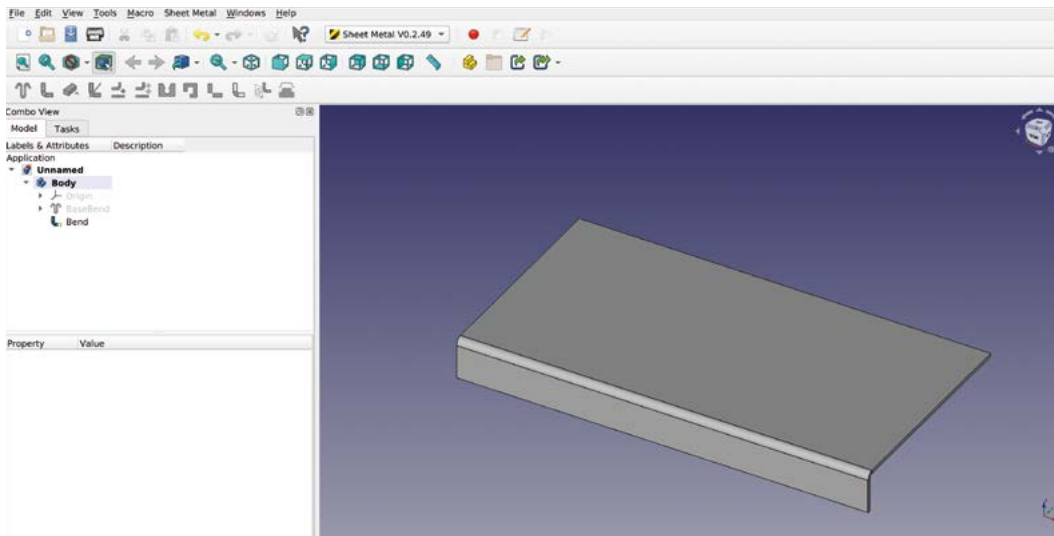
Inside the sketch, let's create a rectangle around the origin point. We don't need to fully constrain this sketch, but let's give it a horizontal and a vertical constraint, making it roughly 12 cm by 6 cm. Once this is done, close the sketch. Without making further changes to this sketch, we can move straight away to the Sheet Metal workbench. In this workbench, with our sketch highlighted in the file tree, let's click the 'Create a sheet metal wall from a sketch' tool icon, which should be the furthest to the left on the Sheet Metal tools toolbar.

You should see that our sketch has been extruded slightly to form a sheet, and that a new object called

'BaseBend' has appeared in our file tree. Similar to if we had extruded our part, we can still make changes to the underlying sketch, and those will be pushed through to the BaseBend object. There are also numerous parameters in the BaseBend object dialog. Notably, you can adjust the thickness of the sheet – this is useful since the BaseBend object, as you will see, defines the sheet thickness for the rest of the attached design.

Next, let's select one of the edges on the BaseBend object. We selected the upmost edge line of one of the longer sides. With that selected, click the 'Extends one or more face, connected by a bend on existing sheet metal' tool icon, which should be second from the left in the Sheet Metal workbench toolbar. You should now see that we have created a new section of our sheet design, folded at 90 degrees to the original sheet (**Figure 2**). This new object appears in the file tree labelled 'Bend' and subsequent bends will be labelled 'Bend001', 'Bend002', etc. Highlighting the 'Bend' object in the file tree, we can adjust plenty of parameters. We'll leave the first parameter, Bend Type, as it is, set at 'Material Outside', but have a glance at the options for later on. You'll note that our new folded section is folded down

**Figure 1** An example design that could be fabricated from a single piece of sheet metal



**YOU'LL NEED**

A computer with FreeCAD 0.19

from the original BaseBend object in the Z axis. If we wanted this section to fold upwards, we can change the 'angle' parameter in the dialog. Setting this to -90 rotates the folded section to point upwards. Similarly, we can set the angle of this fold to any amount we choose. Moving down the parameter list, we can use the 'gap1' and 'gap2' parameters to make the folded object not the full length of our attached BaseBend edge. So, for example, in **Figure 3**, we have added a gap value of 10 mm to each of those parameters.

**Corner relief is a small cutaway that, similar to the earlier notches, stops the metal distorting when folded**

You may need to click the 'Recomputes the current active document' button or press **CTRL+R** to see the changes in your model.

You'll notice that not only does the bend object reduce in length by the gap amount, but also that there are some small 'relief' notches automatically added at the end point of the bend. This is good practice in sheet metal work as, if you fold a bend that connects to a straight edge, the end of the bend will distort the straight edge at the point it joins it. Adding the notch stops this distortion from occurring.

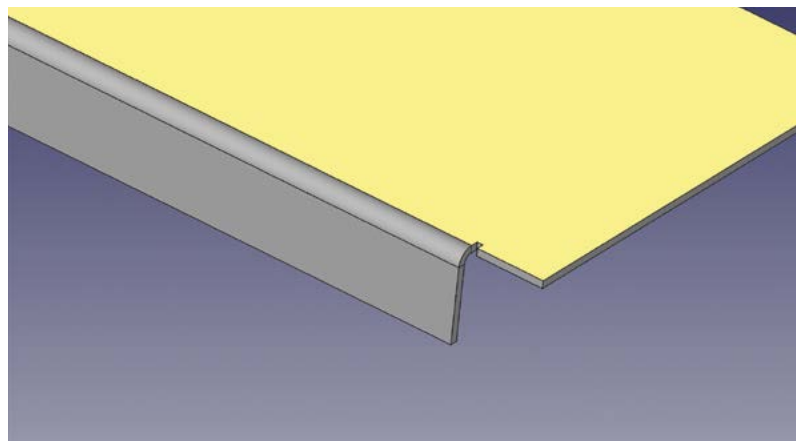
If you wanted to not have a relief notch added, you can scroll down to the 'Parameters relief' section and set the relief factor to '0' and then set the 'use relief factor' setting to 'true'. This option might be useful if you are using the Sheet Metal workbench to design using different materials, such as thin card or plastics. Before we move on, please also note that, in the 'bend' object dialog, you can change the length of the added bend part. Before we add more bends, undo or delete any changes you have made so that we have our simple BaseBend, and our first bend object that is full length with no gaps, etc.

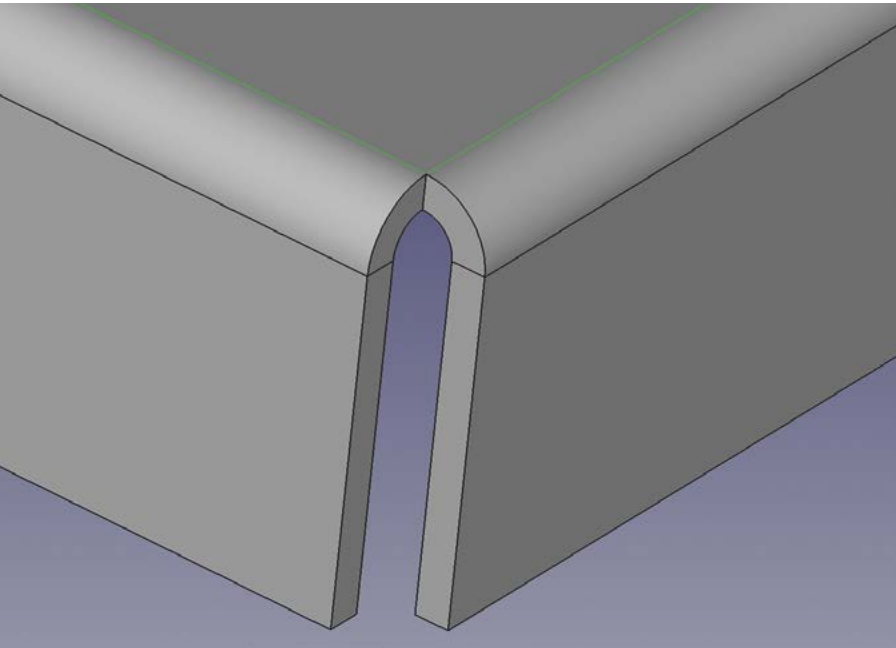
Next, let's select one of the short edges of our BaseBend rectangle sheet and add a second bend to create a wall at 90 degrees. You'll notice that at the corner where the two folds meet, there is a small gap. This is a by-product of working in sheet metal, where the radius of a fold means that folded sections stand slightly off the BaseBend object. You also may note that the two folds join together at a very sharp point where they join the BaseBend object. Again, in real life, that sharp convergence point could create

distortions in the piece as it is folded, so it can be a good idea to add some corner relief. Corner relief is a small cutaway that, similar to the earlier notches, stops the metal distorting when folded. To add corner relief, we need to select the two edges which run into the corner on the BaseBend object. You can see these edges selected in **Figure 4**. →

**Figure 2** Creating an initial 'BaseBend' object and adding our first folded section

**Figure 3** Adding gaps automatically can add notches which would allow sheet metal to be folded without distorting at the fold point

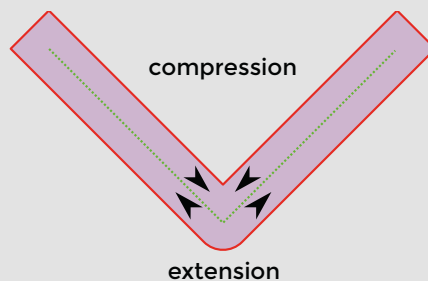




**Figure 4** To set up a corner relief, you must select the two edges that run into a corner point between folds

### FOLD GEOMETRY

When you fold sheet materials, including sheet metals, there are numerous forces in play inside the fold. On the inside of the fold, the material is under a compression force and, on the outside of the fold, the material is being expanded. In the diagram below, the dotted green line represents the line through the material where these forces swap from compression to extension and vice versa. This line is called the neutral axis. In different materials and at different thicknesses of materials, this line will be in different positions. The reason this is important is that it dictates where fold lines are accurately placed to create the overall dimension of a piece accurately. The position of the neutral axis is given as a ratio of the material's thickness; this ratio value is called the K-factor. You can search online for the K-factor of a given material at a given thickness, but also be aware of what industrial standard the K-factor value is being stated in, either ANSI or DIN. We found that a K-factor ratio of 0.4 ANSI was commonly given for 1 mm aluminium sheet. Using this value when using the 'Flatten sheet metal folded object' tool will ensure that all your fold geometry is accurate for the material you wish to use.



With the two lines selected, the 'Corner Relief to sheet metal corner' tool icon should become active (seventh from the left on the Sheet Metal workbench toolbar). Clicking the tool should create a corner relief object in the file tree, and also create a circular hole in the corner of the two folds (Figure 5). There are options for other corner relief geometries in the corner relief object dialog. Whilst a circular relief might be easy to create in a flat sheet design using a drill, you might prefer a square relief or another shape. Finally, there are also options for 'circle scaled' and 'square scaled' geometries. These are useful as, if we use a scaled corner relief but then add other folds around that corner, as we are about to do, the scaled relief is sized so that it won't interfere with the subsequent fold. Therefore, after experimenting, set the corner relief to 'circle scaled'.

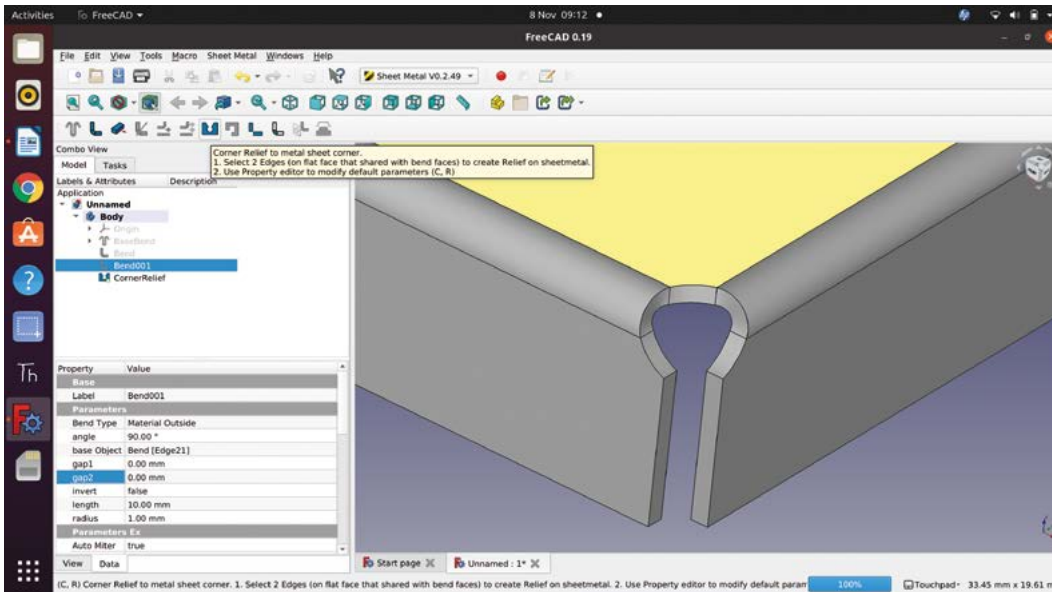
As you can see, we automatically appear to be making a tiny metal tray or lid! We might in real life want to create folds around the corners of the side walls to create a very rigid structure. If we select one of the outer edges of the shorter sides folded wall and click the 'Extends one or more faces' tool again, another bend object appears and we now have a folded metal piece that completes the corner. However, this piece currently sits inside/on top of the other folded wall section (Figure 6). Of course, this would be impossible to make, so we need to use an offset to place this fold correctly.

### ADD AN OFFSET

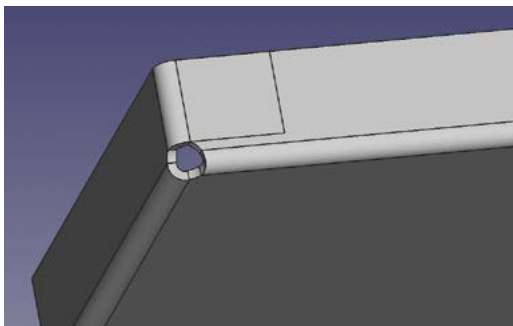
Highlight the new bend object in the file tree and, in the dialog, click the drop-down menu for the 'Bend Type' option. Select 'Offset', and now the new fold will be offset by the amount specified by the 'offset' field further down the dialog. Our material is 1 mm thick, so if we change the offset amount to 1 mm, the new section is on the outside of the two tray walls. Or, if we input -1 mm, then the fold sits on the inside of the walls. Whilst this works, it does mean that our material touches inside the folded overlapping sections. This becomes an issue later in the process when we want to flatten our design, as it requires a clearance between folded surfaces. Therefore, set your offsets to 1.1 mm to create external folds with a small clearance. Having created all the parts to make one corner of our metal tray, we can continue around the BaseBend object, adding further folds and corner reliefs until we have four walls with folded corners.

One interesting thing to note about designs made this way on the Sheet Metal workbench is that they can still be manipulated and worked on by tools on other workbenches as normal. One quick example is to





**Figure 5** Adding corner relief to points where folds adjoin can make it easier to produce your design accurately in sheet metal

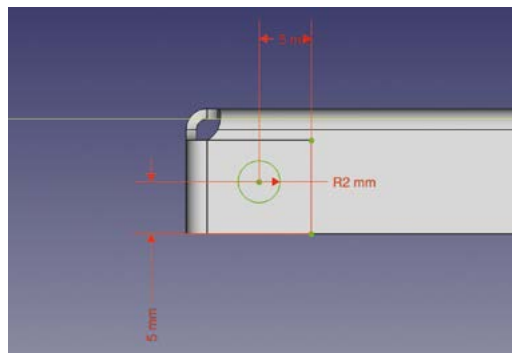


move to the Part Design workbench, select a suitable edge, and apply a chamfer or a fillet. A more useful example is to perhaps add sketches to our metal tray design. If we were to fabricate this tray, we might like to add holes in the design for bolts or rivets to fix the folded corners firmly. To add a sketch to this design, you work exactly as if you were adding a sketch to any face in any design. First, move to the Part Design workbench and select one of the external folded tab faces and click the 'Add a sketch' button. We then drew a 2 mm radius circle, imagining we might use a 4 mm diameter rivet. Again, just like any sketch on a face, we used the 'Create an edge linked to an external geometry' tool to be able to position our circle relative to the end of the folded tab, (**Figure 7**).

Closing the sketch, we then used the pocket tool on the Part Design workbench to create a hole, and selected 'through all' as the type so that the holes would be created on both sides of the design. Whilst we could have done this in a single sketch, we added another sketch to create the same holes at the other end of our tray.

To fabricate an object, such as our tray created from a folded sheet, we need to be able to flatten

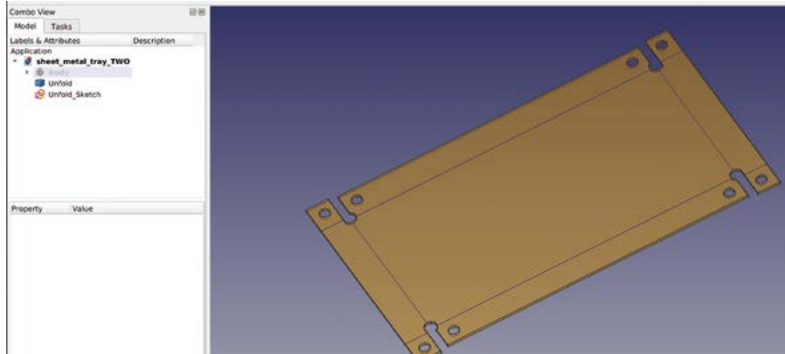
our design back out after we have completed it. Flattening and unfolding the design then allows us to see the basic shape of the flat sheet that we need to cut to create our object. To flatten the design on the Sheet Metal workbench, we need to select a face which will be the reference plane to flatten the part to. With our metal tray design, the obvious choice is to pick the outer large surface of the BaseBend object. With that face highlighted, you then need to click the 'Flatten sheet metal folded object' tool icon, which is fifth from the left on the Sheet Metal workbench toolbar. You should now see a dialog box appear, titled 'unfold sheet metal object'; you may also see that the report window opens at the bottom of the screen with a report that 'engineering mode is not enabled'. Don't worry about the report window message: just close the report window. In the dialog box, make sure that 'generate projection sketch' is ticked and then also tick the 'Manual K-Factor' box. When you tick that box, you will need to input a K-factor value. We read that an 0.4 ANSI value was appropriate for our 1 mm thick sheet metal design when working in aluminium. →



**Figure 6** Initially when you create an overlapping corner, it is placed directly on top of the other folds

**Figure 7** Setting up a sketch to create holes for fixtures in our tabbed metal tray

## TUTORIAL



**Figure 8** Flattening our design creates a flat 3D object of our unfolded sheet, and also a sketch object

Having input 0.4 and ticked 'ANSI', we can then click the 'OK' button. Depending on your computer, it may take a few moments but, once processed, you should now see two new objects in the file tree view – 'unfold' and 'unfold sketch'. These two new items exist outside of the active body containing our folded design; so, to tidy the file tree view, we can close the drop-down menu of the active body so that our file tree just has three visible list items: 'Body' and the two new unfolded items. You can also see in the preview window our two new items: a blue line sketch and a semi-transparent unfolded sheet of our design. Toggling off the Body item in the file tree means we can inspect these items more clearly (**Figure 8**). Of course, like most objects, we can change the appearance and position of these items.

### NUMEROUS USES

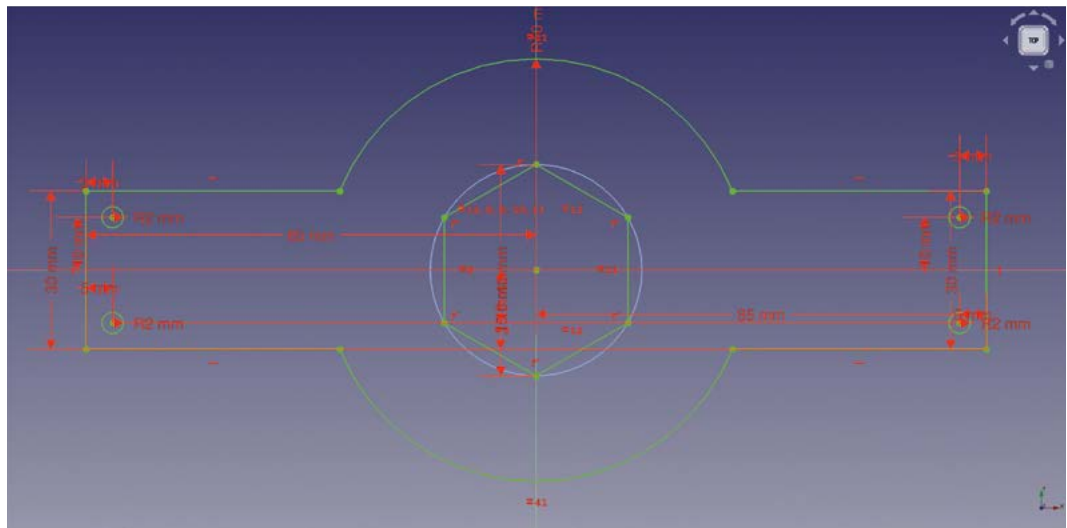
We can use these items in numerous ways. For example, we might use the 'Unfold' object to be the basis of an engineering drawing by pushing views of the object through to the TechDraw workbench and adding dimensions and coordinates. This is useful if you needed to traditionally mark or scribe a layout onto sheet metal. You could also make only the

sketch item visible, and then highlight it and use File > Export to export a variety of file types (DXF, SVG, and many more) to create printable plans, or to use to create G-codes for a milling machine or to cut on a laser cutter.

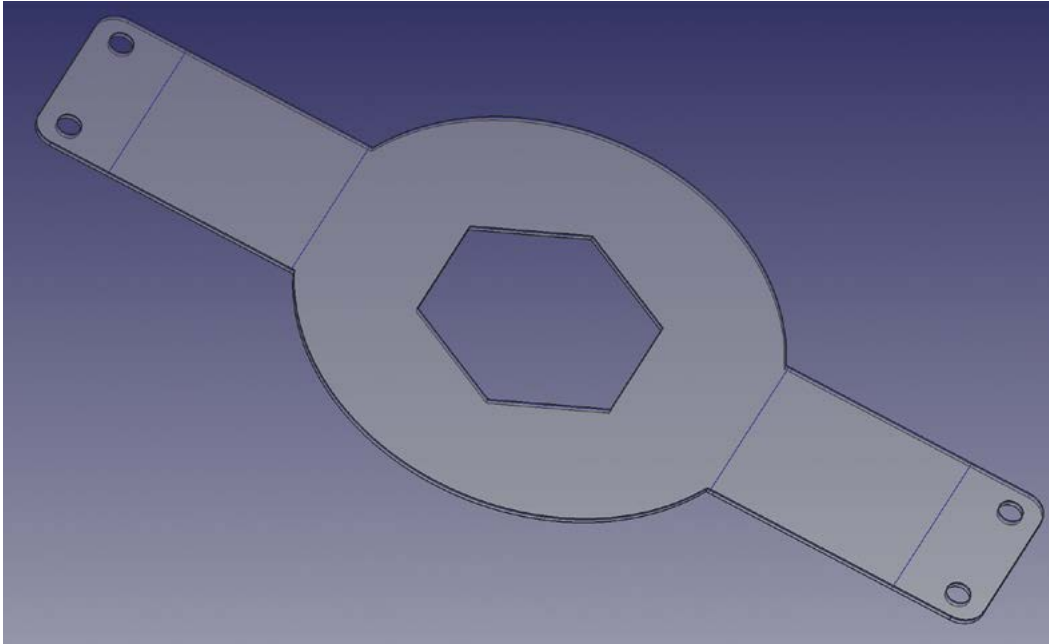
Whilst there is a lot of mileage in what we have looked at so far, there is the fact that everything we designed in our tray example was a fold that started or extended from an existing edge of an object. Let's look at using sketches to create fold lines that are not on the edge of items but inside the face of a sheet. To begin, we created a new project, moved to the Part Design workbench, and created a sketch in the XY plane. In the sketch, we drew the object in **Figure 9**. You don't have to faithfully recreate this sketch, but you can create something similar to play with these techniques.

Moving back to the Sheet Metal workbench for a moment, we selected our sketch and clicked the 'Create a sheet metal wall from a sketch' tool icon again to create a basic BaseBend object. Notice that, similar to padding or extruding a sketch, this tool acknowledges that internal geometry is going to be a void. Next, we want to create some further sketches that will act as folding lines for our project. Let's aim to fold each side wing twice at 45 degrees. Move again to the Part Design workbench, highlight the upper face of our BaseBend object, and create a sketch on it.

For our first fold sketch, we drew a vertical line across one of our wings 15mm in from the edge, which we imported using the 'Create a linked edge' tool. Once this single line was set up, we closed the sketch and returned to the Sheet Metal workbench.



**Figure 9** A sketch that contains a number of internal holes and has side 'wings' to be folded in numerous places



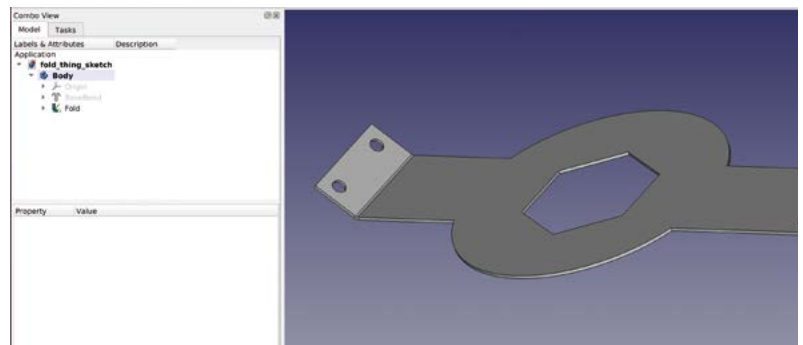
**Figure 11** ♦ Our winged object, flattened, has retained all the additional features and folding points on the sketch and 3D object

**Figure 10** ♦ Our first fold using a sketch line as a fold position

To create this fold, you first need to select the face where the sketch is attached on the BaseBend object in the preview window; this feels a little counter-intuitive and we naturally would select the whole BaseBend object in the file tree, but this doesn't work. With the correct face selected, hold the **CTRL** key and click the sketch in the file tree. With these two items highlighted, you should now see that the 'Fold a wall of metal sheet' tool becomes visible. Click this tool icon and you should see a 90-degree bend appear in your part at the sketched line, a 'fold' item appears in the file tree, and the sketch should be toggled to not visible. Highlighting the fold item, you can then use the dialog to make changes – we set our fold to 45 degrees (**Figure 10**).

## SUMMING UP

For our next fold, we again used the Part Design and the Sketcher workbench to create a sketch containing a line that went across the 'wing' at the point it connected with the circular centre section of our object. Again, we created edges linked to external geometry to be able to draw the line precisely at those points. Moving back to the Sheet Metal workbench, we again selected the upper face of the object and then selected our sketch containing the fold line. Applying the 'Fold a wall of sheet metal' tool, we again set the fold angle to 45 degrees and, this time, we also changed the 'position' to 'backwards' as this meant the radius of the fold lay outside the flat



area of the circle rather than inside it. We repeated the process above for the other side of the object and, as a finishing touch, we added a chamfer to the upper wing corners using the chamfer tool in the Part Design workbench. You can see the completed item in **Figure 1**. One of the reasons we added the chamfers was to prove that even when you add geometry on other workbenches, the 'Flatten folded sheet metal object' will still work correctly and carries through all geometry on the designed object. In **Figure 11**, you can see that we have flattened our designed part, and everything is still present and correct.

It's been a pleasure to explore this workbench and, in the most part, we have found it very straightforward in use. We particularly like that the workbench can accomplish so much with so few tools, and this makes for a pretty straightforward experience. □

## QUICK TIP

When creating sketches that will act as fold lines, you need to create each line in a separate sketch, as you will need to adjust fold parameters individually.

CODE  
THE  
CLASSICS  
VOLUME 1

# CODE THE CLASSICS VOLUME 1



Brimble  
Crookes  
Gillett  
Malone  
Tracey  
Upton



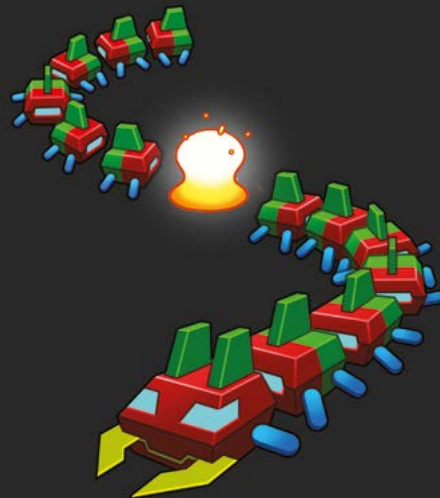


# CODE THE CLASSICS VOLUME 1

This stunning 224-page hardback book not only tells the stories of some of the seminal video games of the 1970s and 1980s, but shows you how to create your own games inspired by them using Python and Pygame Zero, following examples programmed by Raspberry Pi founder Eben Upton.



- *Get game design tips and tricks from the masters*
- *Explore the code listing and find out how they work*
- *Download and play game examples by Eben Upton*
- *Learn how to code your own games with Pygame Zero*



Available now [hsmag.cc/store](https://hsmag.cc/store)

# Digital cutting with craft vinyl

Add some vinyl adornments and beautification to... well, pretty much anything!



Nicola King

@holtonhandmade


Nicola King is a freelance writer and sub-editor who also enjoys trying her hand at new crafts on a very regular basis. Her 'craft room' is looking rather full...



**Over recent years, digital cutting machines have become hugely popular amongst the crafting and making communities.** Brands such as Brother, Silhouette, Cricut, to name a few, have developed

a range of machines that enable users to cut bespoke shapes from all sorts of materials, including cardstock, foam boards, leather, and even thin metal sheets. The key advantages to using such a machine are the degree of precision and uniformity that you get, the ability to cut extremely complex shapes, along with the speed of cutting – you could certainly try cutting such things by hand, but the results achieved with a digital cutting machine would be far more impressive in comparison.

Finally arriving at the digital cutting party earlier this year, this author purchased a Cricut Joy ([hsmag.cc/CricutJoy](http://hsmag.cc/CricutJoy)), one of the smaller and less expensive options in the marketplace. This particular machine is useful if you want to cut vinyl (one of the most used materials in the crafting and design industry), and provides an easy way of adding a graphical element to just about anything you want. So, for those new to cutting vinyl, in this tutorial we'll take an introductory look at how to use a digital cutting machine to add some vinyl embellishments to everyday items, with a warning that once you start messing about with vinyl cutting, it's difficult to stop – the world of digital cutting is something of a rabbit hole. You'll find yourself looking around the house for things to label, decorate, and generally

**Above**  The results of our labours: the finished HackSpace mug, ready for our next coffee break



**Above** You can add your designs to a vast array of items

improve with some colourful vinyl images, graphics, and pearls of wisdom.

### THE BASICS

Firstly, it only seems fitting for this tutorial that we embellish something with the HackSpace logo, so we've chosen an inexpensive, plain white mug that was idling in the back of the cupboard as our base. Ceramics are an easy item to stick vinyl to, and they make great personalised gifts.

In terms of the vinyl we've used here, it's simply the branded Cricut adhesive-backed, permanent vinyl that can be found online. However, don't feel that you need to stick with a certain brand, as vinyl choices are wide, and a search on Amazon will soon throw up many different options. We've also used a holographic, non-brand vinyl on a couple of items, and it worked just as well. With our cutting machine plugged in, and our iPad to hand to control the cutting process, we're almost ready to start.

### DESIGN

Many of the digital cutting machine manufacturers have created design 'spaces' for users of machines to upload to and create their designs in. Some you need to pay for and subscribe to; others are free for a certain number of image uploads – it really depends on the manufacturer and machine you are using.

In terms of this tutorial, we will be using the Cricut Design Space, which you can get as a free companion app on your smartphone or iPad, and it's designed to work specifically with machines

from the Cricut family. This author does purchase a monthly subscription to Cricut Access, which enables access to a huge number of extra designs, one of which we've used on a bath bomb holder (see image below). It's not necessary to sign up to these subscriptions, but it often provides access to thousands of designs and projects that you'd otherwise have to pay for.

In order to digitally cut your vinyl, whatever design you have needs to be a vector (directional) image, in our case an SVG file – it's a common type of vector file that many cutting machines use to determine in which direction to send the blade. For this tutorial, we initially used Adobe Illustrator vector-based software. We took our logo into Illustrator and edited it slightly before saving it as an SVG file. You can do the same thing in Inkscape – many of you will already be familiar with these pieces of software. Once you have done that and your file is ready to go, the rest is easy!



**Above** This is the Cricut Design Space, on the iPad, in which we adjusted and positioned the logo

## BLANK CHECK

Whilst it's obviously a good idea to upcycle/improve an item that you already own, if you don't already possess anything that you'd like to enhance with some vinyl flourishes, or you are considering making gifts for people, then craft blanks may be the answer, and we've used some of these as examples within this tutorial.

There is a huge array of various bases available in the marketplace, including acrylic (think coasters, key rings, baubles, drinking bottles), glass blanks (such as vases, tea light holders, storage jars), ceramic bases (such as mugs, money boxes, tiles, plant pots), along with wooden, metal, and textile blanks. A search on the internet will soon give you plenty of options, and websites such as [amazon.co.uk](http://amazon.co.uk) and [hobbycraft.com](http://hobbycraft.com) have a host of choices. With a craft blank you are starting from scratch, and the world is your oyster in terms of how far you go in personalising or embellishing your item.



### YOU'LL NEED

- ◆ Access to a digital cutting machine (and a device to control your cutting machine, e.g. iPad)
- ◆ An item to be embellished
- ◆ Craft vinyl
- ◆ Transfer tape
- ◆ Weeding tool and scraper
- ◆ Scissors



**Above** ♦ Our digital cutting machine in action, its blade following the vector design

**Below** ♦ 'Weeding' is the process of removing excess vinyl from the design

### QUICK TIP

Think about the colour of the object you're decorating before choosing a vinyl colour that will stand out well against it – a darker colour works well on glass and acrylic.



### VINYL VARIETY



For this tutorial, we've used a permanent, adhesive-backed vinyl – the design you create with this will stick to your item, and can't be moved, and this is particularly useful if you are embellishing plant pots, for example, or anything that might sit outdoors. It's also perfect for mugs that might go through a dishwashing cycle. However, that's not your only option, as the range of vinyl types available is ever-growing, and they come in a range of colours and finishes, from holographic to glitter to chalkboard.

If you want to remove a design from something, then there are adhesive types of vinyl that are specifically for temporary application, and these are a great idea for a first project, since they are easier to work with as the adhesive is not as strong. There is also adhesive vinyl that is temperature-sensitive, so will change colour if placed on a mug that's filled with hot water. In addition, as well as adhesive-backed, you've also got the option of using heat-transfer vinyl, which you iron on to textiles such as bags, cushions, and T-shirts – something that we looked at recently in HackSpace, issue 46 ([hsmag.cc/issue46](http://hsmag.cc/issue46)).

### UPLOAD AND PREPARE TO CUT

Using your smartphone or whatever device you have linked up to your cutting machine, upload your image. In Design Space, on the 'Canvas', we sized our image to fit the mug and just tweaked it until we were happy with the dimensions, 'ungrouping' it so that we could edit it properly. Edit your image at this point if you need or want to. Of course, you don't need to upload an image from somewhere else; you can design your own in Design Space for example, or use the free or purchasable images available to you there – it's your choice. Easy example: you could just choose a font and create someone's name, ready for printing onto an item.

### CUTTING

Happy with the design? Now, let's cut it. With our machine, and using the design facilities available to us, there's an option at the bottom of the screen to 'Make it'.

It's then just a case of following the directions given. Our machine asked us if we would be using a mat or not to cut. With the roll of vinyl we were using, this wasn't necessary, so we proceeded to the next step, which was selecting the type of vinyl we were going to use – in our case 'Smart Vinyl – Permanent'.

At this point, we found that it wanted to cut out the HackSpace logo as separate, rearranged letters, as shown in the on-screen preview – this can be resolved by selecting the Actions > Attach option for the selected image on the Canvas, so it then prints as a single entity, with the letters in the correct order.

The machine then asks you to load the materials required, and all that involves is feeding the end of the vinyl roll into the mouth of the machine. The machine grabs the end of the vinyl, pulls it in and checks the size is adequate for cutting desired image, and then all you have to do is select 'Go' for the machine to begin the cutting process. Watching the blade deftly cut back and forth, up and down, knowing exactly where it has to go, is a mesmerizing and decidedly quick process. We actually cut two of our HackSpace image – one for either side of the mug.

### PREPARING TO STICK!

Once your machine has finished cutting, you'll normally be given an option to unload the vinyl, then it's back to you, and time to prepare the vinyl in readiness for sticking. Cut off, from the rest of the roll, the section of vinyl that's been worked on. Now, we need to 'weed' the vinyl – nothing to do with gardening, it just means removing the excess vinyl from the piece. Specialist weeding tools can





be substituted with a pair of tweezers or similar implement. Carefully pull off the vinyl around the image (it should come away pretty easily) and you should just be left with your design.

Next, we need to transfer the design to our mug; for that, we need some form of transfer tape. We are using the branded version here but, again, there are non-branded tapes available if you look for them. Cut a piece of tape to the size of your image, and remove the sticky part from the backing paper. Then carefully place this, sticky side down, on top of your image so that it is completely covered. The transfer paper usually has grid lines on it to help you line things up.

### TRANSFERRING YOUR IMAGE

Now we need to make sure that the tape picks up the image, so we need some sort of scraper to push over the top of the tape (and image) to ensure full adhesion. This can take a little bit of time, but scrape backwards and forwards until the image is stuck to the tape – you can pull the tape off slightly to check it's worked. If not, stick back down and give it another sweep.

When fully adhered, remove the tape, with the image, from the vinyl backing and position the image on your item. Do this slowly and carefully to ensure you place it correctly – once it's stuck down, permanent vinyl will be difficult to remove. (Removable vinyl gives you more flexibility – see the Vinyl Variety box for more info). Press the image and tape down until it's stuck, remove the transfer tape, and there you have it – in our case, one super-cool mug to take pride of place on the mug tree.

### TAKE THE PLUNGE

If you are particularly keen on the idea of bedecking mugs, Cricut actually recently brought out a specialised mug press ([hsmag.cc/mugpress](http://hsmag.cc/mugpress)). This machine is basically

a heat press that works with Cricut's specialist ink to transfer designs onto mugs, and it might be an attractive option for some makers. However, simply adding vinyl to mugs, as we've done here, is still a pretty effective way of customising a piece of crockery.

Just think of the possibilities – gifting is made so much easier when you can tailor items to an individual, and when our son knows who he's got in this year's Secret Santa at school, we plan on personalising their gift with an abundance of vinyl! This small machine and the long rolls of vinyl also make it easy to make banners – so wishing your nearest and dearest a happy birthday with a banner you've made yourself is achievable.

Cutting vinyl could also be a new business idea for you; plenty of people make money from crafting vinyl – just take a look on [etsy.com](http://etsy.com) for some examples. Whichever brand of cutting machine you have access to, get vinyl cutting, add some colour to your world, and see what designs your creativity can dream up. ▣

**Left** ▣  
We've successfully transferred our vinyl design to the tape

**Below** ▣  
Transferring the design from the tape to the mug – be careful how you line it up



## SOME SOURCES OF INSPIRATION

There is a multitude of online resources to get those creative ideas flowing. Here are just a few:

- Hobbycraft Ideas Hub – [hsmag.cc/HobbycraftIdeas](http://hsmag.cc/HobbycraftIdeas)
- YouTube (just search for 'digital vinyl cutting' and be amazed by what pops up) – [youtube.com](http://youtube.com)
- Cricut homepage – [cricut.com](http://cricut.com)
- Pinterest (here's an inspirational page) – [hsmag.cc/PinterestVinyl](http://hsmag.cc/PinterestVinyl)
- Crafts Selection (some easy ideas here) – [hsmag.cc/CraftSelectionVinyl](http://hsmag.cc/CraftSelectionVinyl)


### QUICK TIP

See what you already own that could be enhanced with a bit of vinyl flair... you'll be amazed at how many items you can find.

# Twinkling LEDs


Light up your Christmas tree



Right  Just set a few parameters and your LEDs will start to flash



Ben Everard

 @ben\_everard

Ben's house is slowly being taken over by 3D printers. He plans to solve this by printing an extension, once he gets enough printers.

**L**ast year this author wrote some code to control some NeoPixel lights on his Christmas tree. He wanted an organic-looking 'twinkling' display.

In a given length of lights, he wanted individual LEDs to fade in and out in a random-looking pattern. He wanted the length of each flash to be independent of the others and to be a different colour. Since then, he's reused this code quite a few times as he likes the effect it gives. While the code isn't perfect, it's quite battle-hardened, and it might be useful for other people working on Christmas lights.

Here's the code in full (you can download it from [hsmag.cc/ChristmasLights](http://hsmag.cc/ChristmasLights)). We'll go through it in a bit more detail later, but if you just want to steal it for your own purposes, we'll first have a look at how to tweak the parameters.

```
import time
import board
import neopixel
try:
    import urandom as random
except ImportError:
    import random
bright_div = 20
numpix = 42 # Number of NeoPixels
pixpin = board.A1
# Pin where NeoPixels are connected
strip = neopixel.NeoPixel(pixpin, numpix,
    brightness=1, auto_write=False)
colors = [
    [232, 100, 255], # Purple
    [200, 200, 20], # Yellow
    [30, 200, 200], # Blue
]
max_len=5
min_len = 2
flashing = []
num_flashes = 5
for i in range(num_flashes):
    pix = random.randint(0, numpix - 1)
    col = random.randint(1, len(colors) - 1)
    flash_len = random.randint(min_len, max_len)
    flashing.append([pix, colors[col], flash_len,
        0, 1])
strip.fill((0,0,0))
while True:
    strip.show()
    for i in range(num_flashes):
        print(flashing[i])
        pix = flashing[i][0]
        brightness = (flashing[i][3]/flashing[i][2])
        colr = (int(flashing[i][1][0]*brightness),
            int(flashing[i][1][1]*brightness),
            int(flashing[i][1][2]*brightness))
        strip[pix] = colr
        if flashing[i][2] == flashing[i][3]:
            flashing[i][4] = -1
        if flashing[i][3] == 0 and flashing[i][4]
```

```

    == -1:
        pix = random.randint(0, numpix - 1)
        col = random.randint(0, len(colors)
            - 1)
        flash_len = random.randint(min_len,
            max_len)
        flashing[i] = [pix, colors[col],
            len, 0, 1]
flash_
    len, 0, 1]
        flashing[i][3] = flashing[i][3] +
            flashing[i][4]
        time.sleep(0.1)

```

### The key things you'll probably need to tweak are:

- The pin you have attached the NeoPixels to (saved as **pixpin**). In this example it's A1, but it should be whatever you have physically connected.
- The number of NeoPixels in your chain. This is stored in **numpix**.
- The different colours you want to flash. This is stored in the list **colors**. Different types of NeoPixel can have very different appearances for the same colour value, so it's worth having a play about here with the particular hardware you're using.
- **max\_len** and **min\_len** are the maximum and minimum length of a flash. These are related to the **time.sleep()** value at the bottom. It can make sense to increase the lengths of the flashes and decrease the sleep value, as this will give a smoother transition in and out of the flash. This depends on the speed of the processor running the animation, though, as in some cases the calculation can take a long time to run.
- The number of LEDs you want on at a given time (this is held in **num\_flashes**). You can balance this for either the effect you want, or the amount of juice your power supply can push out.

Tweak those above values and you can customise this code for your particular project. Let's now take a look at how it works. Everything is controlled by the **flashing** list. Each entry in this list is a five-item list that contains:

1. The number of the NeoPixel to flash
2. The colour to flash it to

```

Mu 1.0.3 - untitled *
untitled * =
1 import time
2 import board
3 import neopixel
4
5 try:
6     import urandom as random
7 except ImportError:
8     import random
9
10 bright_div = 20
11 numpix = 42 # Number of NeoPixels
12 pixpin = board.A1
13 # Pin where NeoPixels are connected
14 strip = neopixel.NeoPixel(pixpin, numpix, brightness=1, auto_write=False)
15 colors = [
16     [232, 100, 255], # Purple
17     [200, 200, 20], # Yellow
18     [30, 200, 200], # Blue
19 ]
20
21 max_len=5
22 min_len = 2
23 flashing = []
24
25 num_flashes = 5
26
27 for i in range(num_flashes):
28     pix = random.randint(0, numpix - 1)
29     col = random.randint(1, len(colors) - 1)
30     flash_len = random.randint(min_len, max_len)
31     flashing.append([pix, colors[col], flash_len, 0, 1])
32
33 strip.fill((0,0,0))
34

```

3. The length of this flash
4. The current position in the flash
5. The increment or decrement (basically, 1 if it's starting to flash or -1 if it's ending the flash) to the next position

Each iteration of the main loop then goes through each entry in the list in turn, and moves it one more position along, calculates the colour it should be, and then sets the pixel to this colour. If the pixel reaches the end of its flash, then a new pixel, colour, and length are selected at random.



**If the pixel reaches the end of its flash, then a new pixel, colour, and length are selected at random**



**Above** ♦  
The code works for any NeoPixel-compatible LEDs, but looks particularly good on LEDs that are spaced out

This code is non-blocking. That means for each iteration of the loop, you're free to do other things. This could be control other lights, read sensor values, send data to other hardware, or anything else. Obviously you might have to adjust the timings to account for that.

That's the code that's powering a surprising amount of our Christmas (and non-Christmas) lights. If it's useful to you, we'd love to see your projects. Get in touch via email or social media. □

DON'T MISS THE **BRAND NEW** ISSUE!



**SUBSCRIBE FROM JUST £5**

- **FREE!** 3 issues for the price of one
- **FREE!** Delivery to your door
- **NO OBLIGATION!** Leave any time



**WORTH  
£20**

**FREE  
PI ZERO 2 W\***

With your 12-month subscription to the print magazine

**magpi.cc/12months**

\* While stocks last

**Buy online: [store.rpipress.cc](https://store.rpipress.cc)**

# FIELD TEST

HACK | MAKE | BUILD | CREATE

Hacker gear poked, prodded, taken apart, and investigated

PG  
108



## HEAT GUN

We test a budget-friendly, surface-mount soldering solution

PG  
112



## SEESAW

Get extra features for your microcontroller

PG  
102



## BEST OF BREED

The best development boards for RP2040



ONLY THE BEST

# Raspberry Pi's RP2040 revisited

What's happened since launch?

By Marc de Vinck

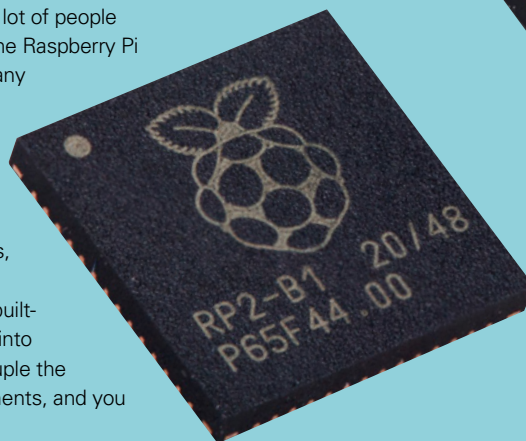
 @devinck

**J**anuary of 2021 was an interesting time for the Raspberry Pi Foundation. It had announced the new 32-bit dual Arm Cortex-M0+ microcontroller integrated circuit, dubbed the RP2040. It was a bold move from a company known for making single-board computers and not microcontrollers. And, as usual from the Raspberry Pi Foundation, it's powerful and affordable, at only \$1 for the bare integrated circuit.

With the introduction of the new microcontroller, the Raspberry Pi Foundation could grab more customers and grow their community. There are a lot of people that love working on a computer, and the Raspberry Pi is an amazing product for them. But many people also find themselves wanting the simplicity of a microcontroller, myself included.

What we didn't expect was the power of the RP2040. It's blazingly fast compared to other microcontrollers, with its 32-bit Arm Cortex-M0+ dual-core processor. It also has lots of built-in features, making it easy to integrate into development boards and products. Couple the RP2040 IC with a few external components, and you have a winning microcontroller.

We covered the new Raspberry Pi Pico and accessories in an earlier roundup. And since the announcement back in January, a robust ecosystem has continued to grow, despite all the supply chain issues going on around the world. In this Best of Breed, we'll look at some of the new development boards that have been built around the RP2040.



# Adafruit ItsyBitsy RP2040 vs Wio RP2040 mini Dev Board

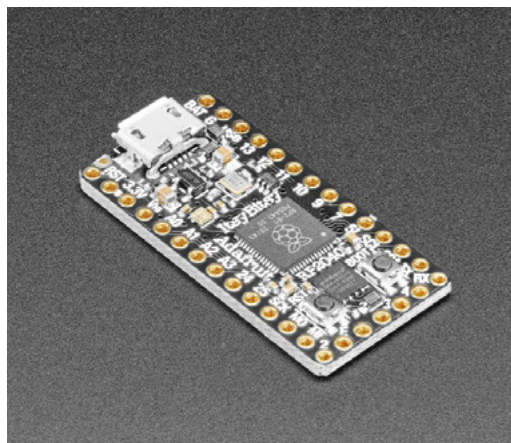
ADAFRUIT ◆ \$9.95 | [adafruit.com](https://adafruit.com)

SEEDSTUDIO ◆ \$12.95 | [seedstudio.com](https://seedstudio.com)

## It's itsy and it's bitsy – it's the Adafruit

**ItsyBitsy RP2040.** At only 1.4" × 0.7" (36mm × 18mm) in size, it's amazing that they were able to pack in so many features and breakout so many pins. Just like all the RP2040 board variants out there, it features a fast dual Arm Cortex-M0+ processor, along with a few other nice features.

They have added an 8MB SPI flash chip for storing all your CircuitPython code, along with an RGB NeoPixel, a red LED connected to pin 11, and both a reset button and bootloader select button, so you don't have to unplug it to launch your code. There are a few other more technical features too, so head on over to the website to learn more about this powerful little board.



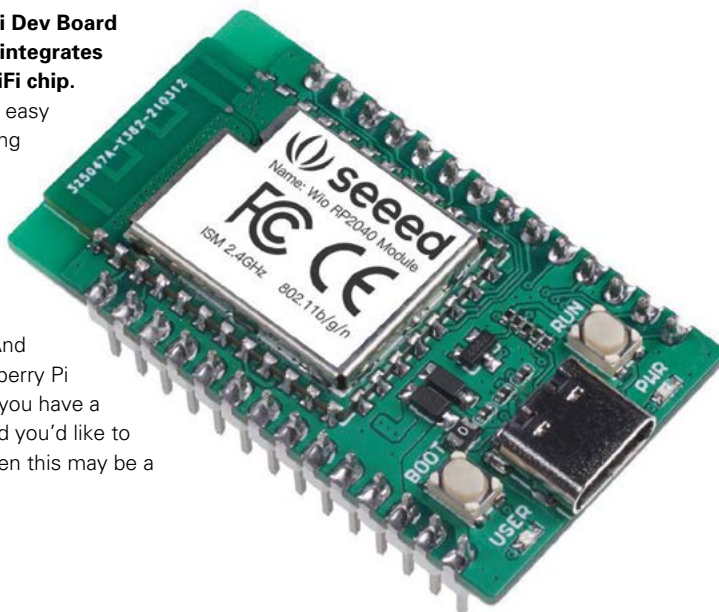
**Left** ◆  
Small, but not too small

**Below** ▣  
Take your RP2040 online

## The Wio RP2040 mini Dev Board from Seeed Studio integrates an RP2040 and a WiFi chip.

Getting connected is easy since it's just like using a Raspberry Pi Pico,

but you get added functionality with integrated WiFi, thanks to an included ESP8285. The available pins on the RP2040 are broken out for easy access, and they are breadboard-friendly. And you can program it just like a Raspberry Pi Pico via the Thonny code editor. If you have a project designed around a Pico, and you'd like to get it connected to the internet, then this may be a good plug-and-play solution. →



## VERDICT

Adafruit ItsyBitsy RP2040

So small and so awesome!

**10**/10

Wio RP2040 mini Dev Board

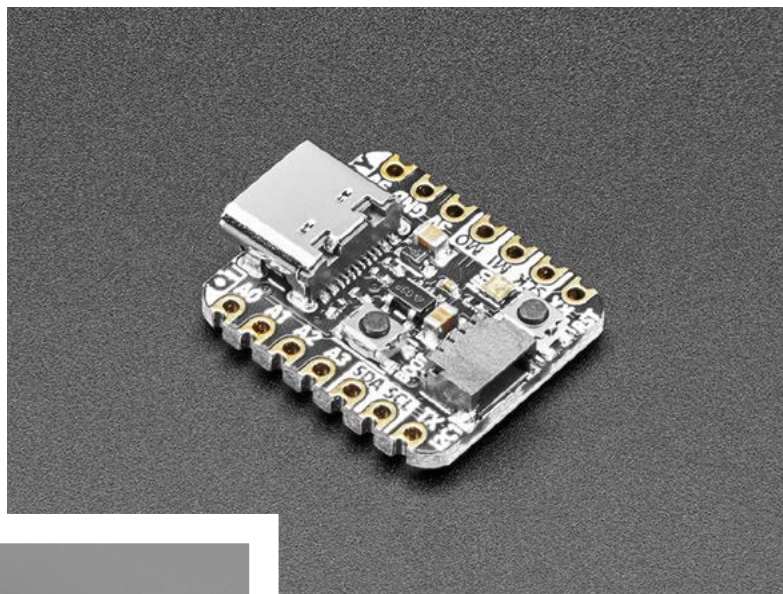
Small and connected.

**9**/10

# Adafruit QT Py RP2040

ADAFRUIT ◆ \$9.95 | adafruit.com

**S**uper-small, and super-cute, it's the Adafruit QT Py RP2040. Much smaller than the ever-popular Feather format, yet it still packs a punch. The board features a USB Type-C port for data and power, a STEMMA QT connector for accessories, and an 8MB SPI flash chip for storing any necessary files and code. My favourite feature is having both a reset button and a bootloader select button for quick restarts. You don't have to unplug the board to start running your code. Adafruit has a growing selection of RP2040 boards, so be sure to check out its site for more information and options.



## VERDICT

Adafruit QT Py RP2040

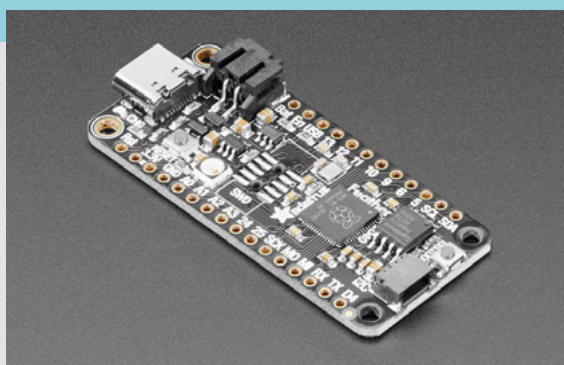
Extra-small but still powerful.

9/10

## ADAFRUIT FEATHER RP2040

ADAFRUIT ◆ \$11.95 | adafruit.com

'You can't go wrong with a Feather' was the tag line for my review of this product in an earlier *Best of Breed* article, and that statement still stands. The RP2040 is powerful, but you'll need it to be integrated into a PCB to use it, and the Adafruit Feather RP2040 is the perfect solution. If you'd like to try out the power of the RP2040, this is a great place to start.



Above ◆  
For when you're short of space



# SparkFun MicroMod RP2040

SPARKFUN ◆ \$11.95 | [sparkfun.com](https://sparkfun.com)

**T**he SparkFun MicroMod Pi RP2040 Processor board is a use-case-specific, low-cost, and high-performance add-on board featuring the RP2040 microcontroller. What makes this board special, and potentially a bit more limited, is the MicroMod interface. That is, unless you already have a MicroMod Carrier Board.

So, what is MicroMod? It's SparkFun's ecosystem of Main Boards, Function Boards, and Processor Boards that all have M.2 form factor connectors. It works by allowing Processor boards to plug into Main Boards or Function boards to add additional

“

What makes this board special, and potentially a bit more limited, is the MicroMod interface

”

capabilities. You could plug the SparkFun MicroMod into an Input and Display Carrier board to add a TFT display and other functions to your RP2040 – all without soldering any components. It's a robust system with lots of options. Learn more about this modular ecosystem on the SparkFun website. →



Above ◆  
Swappable CPUs  
for your projects

## VERDICT

SparkFun  
MicroMod  
RP2040

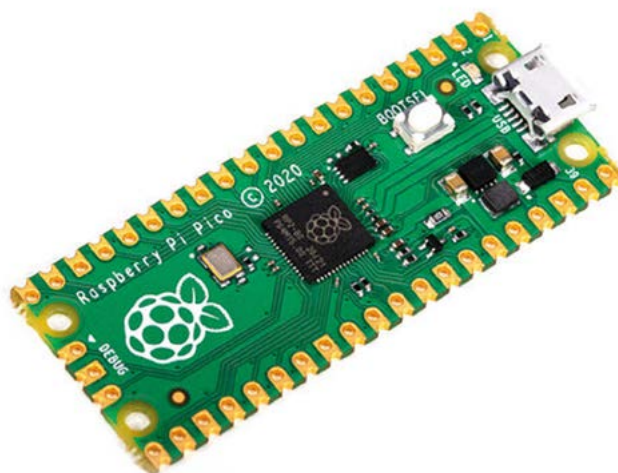
An M.2-  
compatible  
RP2040.

8/10

## RASPBERRY PI PICO

RASPBERRY PI ◆ \$4 | [raspberrypi.com](https://raspberrypi.com)

The Raspberry Pi Pico is the original RP2040 board brought to you from the Raspberry Pi Foundation itself. It's low-cost, powerful, and features a dual-core Arm Cortex-M0+ processor with 264kB internal RAM. Since it's brought to you by Raspberry Pi, it's a must-have for getting started with the RP2040 microcontroller.

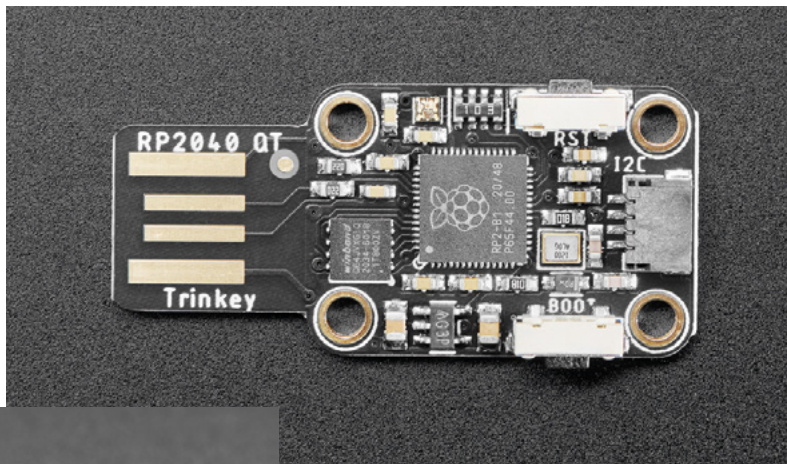
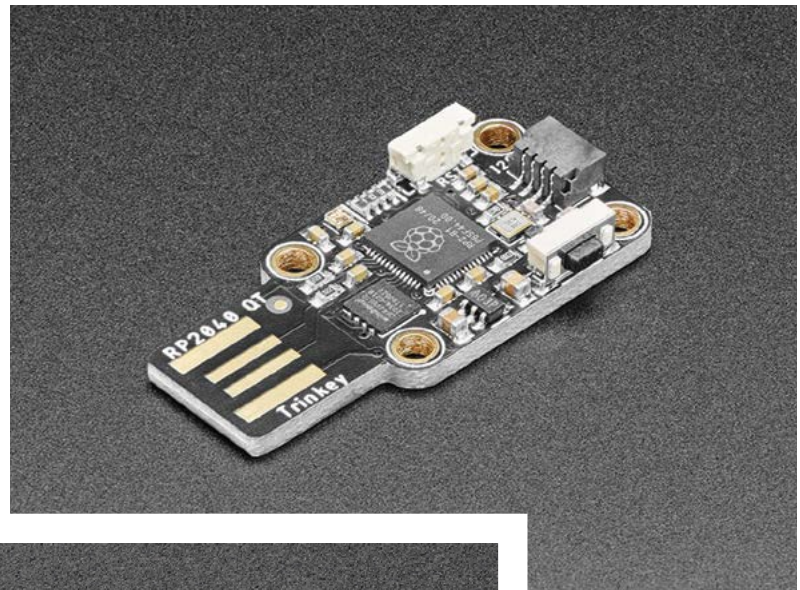


# Adafruit Trinkey QT2040

ADAFRUIT ◆ \$7.50 | adafruit.com

**Is this a USB key, or microcontroller?** The answer is both! Adafruit has packed an RP2040 onto a PCB that allows you to simply plug it directly into any available USB port. No cables required! Or, at least, not for connecting the RP2040. The board, however, will most likely have some wires coming off it, since there is also an integrated STEMMA QT port on the end of the PCB. This allows you to simply plug and play with dozens of different sensors, displays, and electronic components.

And in such a small package, you'd think there wasn't anything more else. But there is! You also get an RGB NeoPixel LED, and 8MB SPI flash for storing your CircuitPython code, and all the components needed to keep your RP2040 running. Simply plug in your Trinkey and get to coding. Easy! □



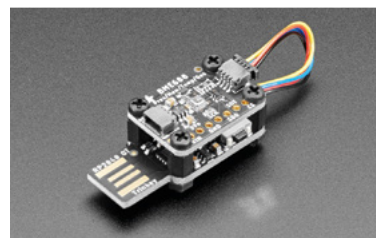
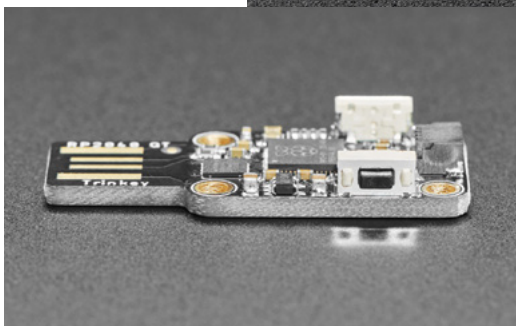
## VERDICT

Adafruit Trinkey QT2040

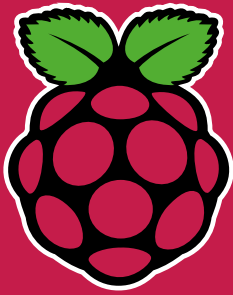
No cable required!

9/10

Left ◆ Add extra features to your computer



THE *Official*

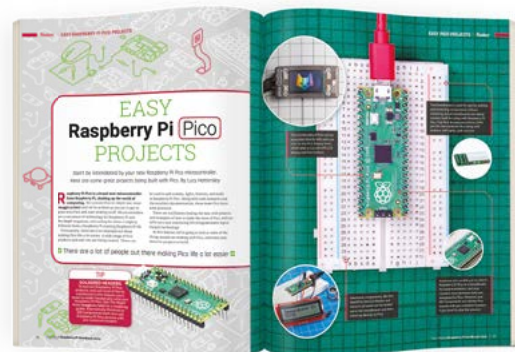


# RASPBERRY PI HANDBOOK

2022

## 200 PAGES OF RASPBERRY PI

- QuickStart guide to setting up your Raspberry Pi computer
- Updated with Raspberry Pi Pico and all the latest kit
- The very best projects built by your Raspberry Pi community
- Discover incredible kit and tutorials for your projects



Buy online: [magpi.cc/store](https://magpi.cc/store)



# Heat gun

We test out a budget soldering tool

By Ben Everard

 @ben\_everard

**S**oldering irons are great, but if you start to work with smaller and more complex components, you might find you reach a point where a hot stick no longer has the dexterity to do what you need.

At this point, you'll need another way of applying heat to your soldered joints. The most flexible and affordable way of doing this is with a heat gun that blasts hot air at your PCBs. We decided to test one of the cheapest ones we could find to see if it was worth the money.

We got a 'JCD Hot air gun 8858 Micro Rework soldering station LED Digital Hair dryer for soldering

700W Heat Gun welding repair tools', from JCD store on AliExpress. It's a little concerning that this is labelled a hair-dryer. It's nowhere near powerful enough for that (but can get hot enough to cause serious injury). It cost £19.94 (including delivery to the UK), which makes it just about the cheapest of the serious hot air tools. You can get cheaper hot air guns, but they tend to be the on/off kind with no control over temperature or airflow, which makes it difficult to use them for soldering.

At just under £20, this tool comes with three nozzles (5, 8, and 10mm), and can fire air at between 100 and 480°C. Once you power it on, press the

**Below** ♦  
The controls are minimal, but functional



Setup button to start, then select the force (for some reason the scale goes from 5 to 10) and temperature. Hold Setup to power off the heater, and the fan will turn off once the temperature drops to 70 degrees.

We were able to solder and remove surface-mount components with this gun without problems, which we'd imagine would be the main use of this. It can also do heat-shrink without any issues. If you're after a heat gun for paint stripping, or other more DIY-y tasks, you might need a more powerful model.

### IN THE HAND

The hand-held part is a bit chunkier than some hot air tools, as the heater and fan are both in the portable part. In others, you often find that the fan is desk-mounted, and it pipes air to the hand-held portion. However, it's not big or heavy enough to cause us any real problems.

With a lot of the functionality in the hand-held part, the desk-mounted part is just a power supply and control panel – it's no larger than a standard laptop power brick. If you're a hobbyist with limited storage space, this can be tucked away in a drawer much more easily than most hot air stations.

There are a couple of drawbacks. The mount for the gun is a bit of a hack. It can be cable-tied onto the top of the device, but this interferes with the controls. Having hot parts exposed this close to where you need to put your hands isn't, in our view, a particularly safe idea. There's nothing to stop you mounting it somewhere else, but you'll need to find a heavy base to make it stable enough.

The second major issue we had was airflow. Unsurprisingly for such a small device, there's quite limited airflow. It was fine for simple use, but it will



**Left** ♦ The hand-held unit is large, but quite light

limit how useful the device is. The website claims 150 L/min which, frankly, is a lie. We don't have the equipment to test this, but it's nowhere near this level. It's about equivalent to a moderate to gentle blow. This author blows harder when whistling.

We also have some concerns about how long this will last. While it worked fine for our test, heat guns are fickle beasts. It takes a lot of power to produce that much

hot air, and the temperature can also take its toll on the parts.

While this hot air gun may lack some features, and we'd like a bit more airflow, there's still plenty here for most uses. Balanced against the price and size, this can be a good choice for light hobbyist use. □

“ **Unsurprisingly for such a small device, there's quite limited airflow** ”

DIRECT FROM SHENZHEN

# THE OFFICIAL Raspberry Pi Beginner's Guide

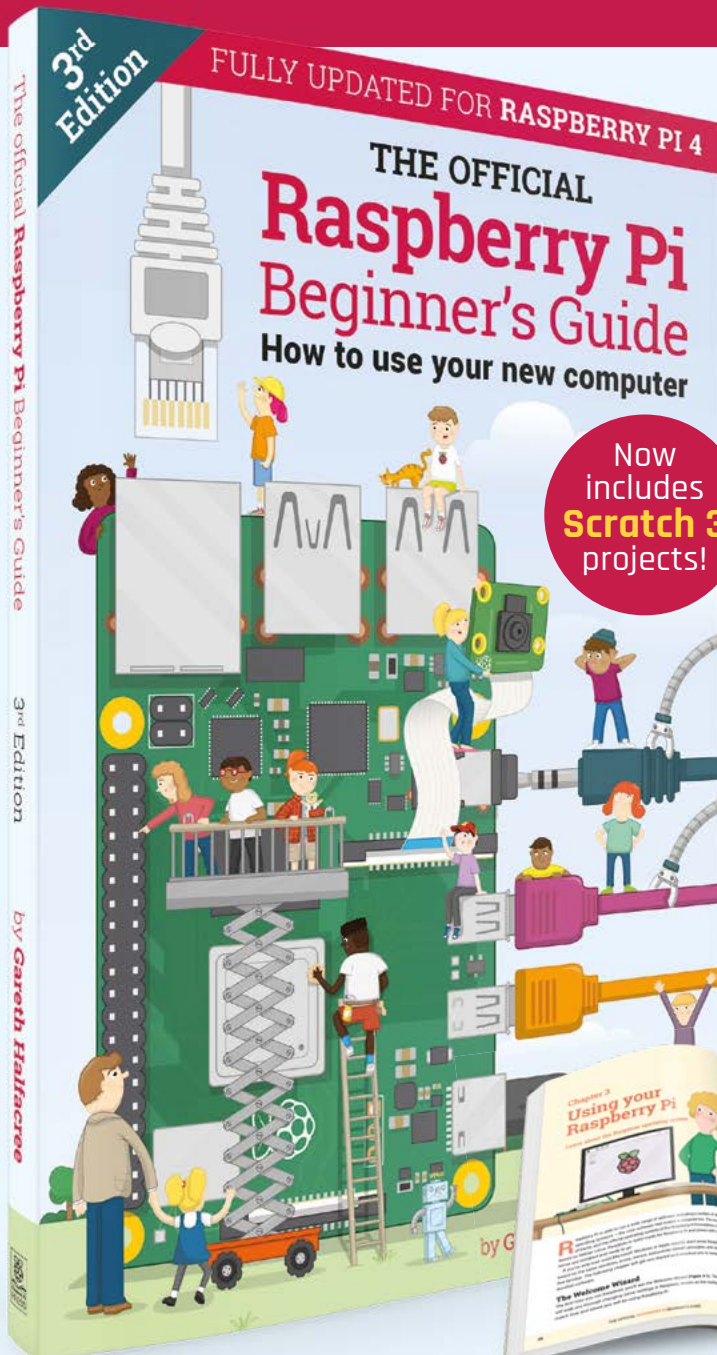
The only guide you  
need to get started  
with Raspberry Pi

## Inside:

- Learn how to set up your Raspberry Pi, install an operating system, and start using it
- Follow step-by-step guides to code your own animations and games, using both the Scratch 3 and Python languages
- Create amazing projects by connecting electronic components to Raspberry Pi's GPIO pins

Plus much, much more!

£10 with **FREE**  
worldwide delivery



Buy online: [magpi.cc/BGbook](http://magpi.cc/BGbook)



# Build a Makerspace for Young People

Join our **free online training course on makerspace design** to get expert advice for setting up a makerspace in your school or community.

Sign up today: [rpf.io/makerspace](https://rpf.io/makerspace)

# Adafruit ATtiny817 Breakout with seesaw

Add more I/Os to your projects

ADAFRUIT  \$4.95 | [adafruit.com](https://adafruit.com)

By Ben Everard

 @ben\_everard

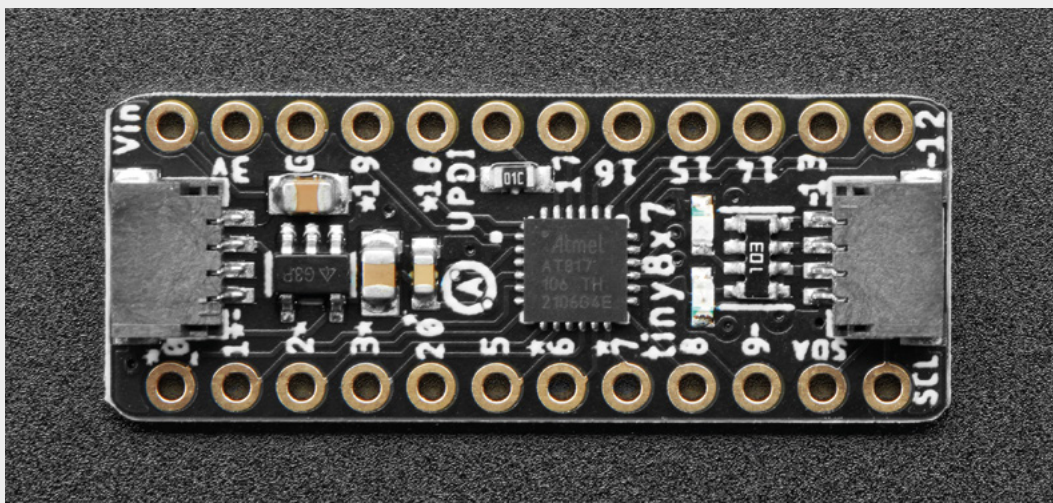
**T**here are literally hundreds of development boards to choose from, with a mind-blowing range of processors, memory, storage, pin count, and size. Why is it, then, that we always seem to be missing a feature when we get to our projects? Sometimes it's because we start with one design and keep adding bits until we run out of pins; other times, it's because we use the dev board we have on hand rather than the most suitable one.


Fortunately, there's a stock of components that can help us. Port expanders, I2C analogue-to-digital converters, and more can be tacked onto most microcontrollers to give us the extra features we

need. They're not too hard to use if you plan them in from the start, but you need space, a PCB, and generally have to spend time thinking about circuits rather than the awesome stuff you want to achieve with your circuits.

Enter the Adafruit ATtiny817 Breakout with seesaw. This is basically a configurable STEMMA QT/Qwiic to almost anything bridge. If you want to add digital I/Os, there are 14 you can use. Nine of them can also be analogue inputs, and five can be PWM outputs.

What we like about this board, though, isn't the specs; it's how easy it is to use. Just plug it in via the STEMMA QT/Qwiic cable and it's all set up. There are libraries for CircuitPython and Arduino, so you can get it working on most maker-level hardware.



**Right**  The ATtiny817 is, as the name suggests, quite small, meaning that this board can also be kept very small



Once the board is plugged in and initialised, you can access the pins almost as though they are native on your main board. Take a look at this CircuitPython example:

```
import time
import board
from adafruit_seesaw.seesaw import Seesaw

ss = Seesaw(board.I2C())

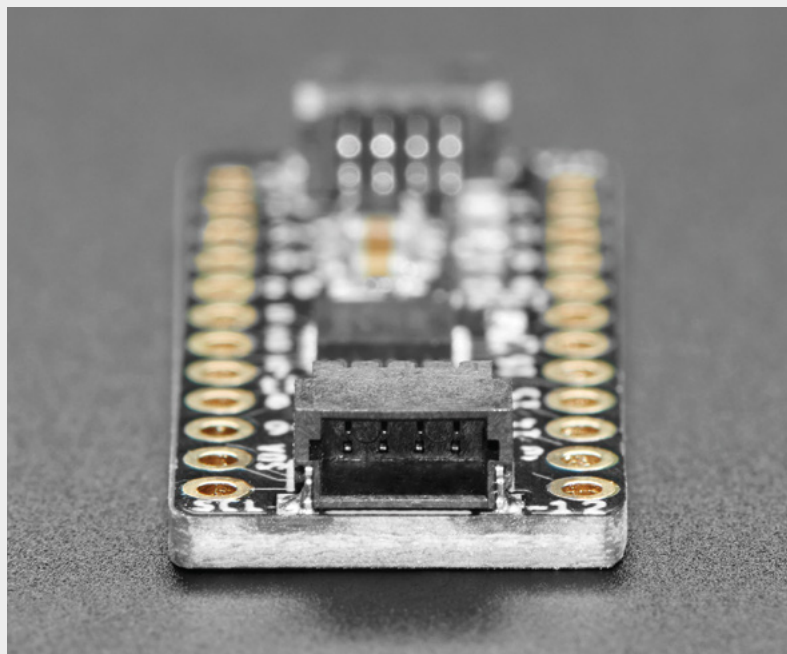
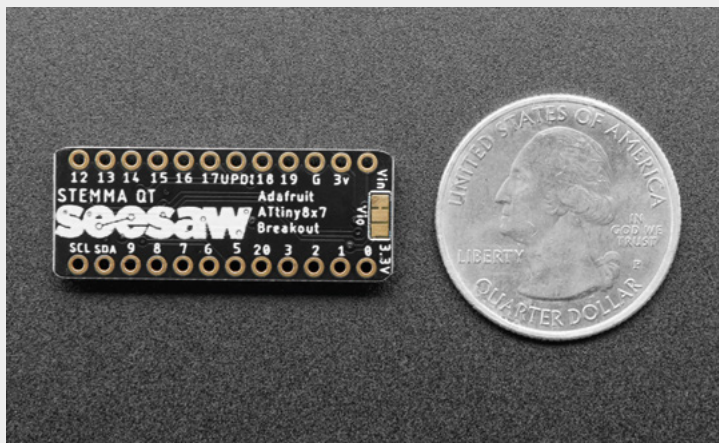
ss.pin_mode(5, ss.OUTPUT)

while True:
    ss.digital_write(5, False)
    time.sleep(1)
    ss.digital_write(5, True)
    time.sleep(1)
```

There's also a buffer for a 60-LED NeoPixel string to let you output to LEDs without having to worry about the timings on your main processor. If you need more features, there are two pins for selecting I2C addresses and two STEMMA QT ports, so you can chain together up to four of them on a single port.

What's nice about this board is how little there is to write about it. There are the specs, and they work. If those specs are what you need in your project, then this board is likely to be a good choice. Often reviews are about caveats and considerations, but in this case, there's not a lot for us to add.

We could talk about how you can use this as a more general ATtiny817 development board, but honestly, don't bother. It's not really designed for this, and you'll need a UPDI programmer – there are better options for only slightly more money. Instead of wasting words on this, we'll leave the space for some lovely pictures of the board in action.



## UPDATE

This board is an updated version of a previous Adafruit product based on the SAM D09. While Arm processors are typically considered an upgrade over AVRs (as in this product), the newer board has more peripherals. Nine ADCs replace the three previously available (although the resolution has dropped from 12 bits to 10 bits), and five PWM pins replace the three on the older board. These extra features, as well as the two STEMMA QT ports, make it a big improvement.

At \$4.95, it's a bit more expensive than using the equivalent specialist IC for a task (such as an I2C port expander for extra GPIO), but it will save you time. How much depends on how familiar you are with the other solutions. It also makes assembly easier as you don't need a PCB or breadboard. How those two things stack up – cost and time – depend on a few things: how familiar you are with the alternatives; what

else is in the projects; whether or not you're likely to reuse the board in another project; how interesting you find spending time learning about alternatives.

We can see it being particularly useful as a way of adding analogue inputs to a Raspberry Pi, but that's really only one part of what it can do. The beauty of this board is its flexibility, ease of use, and its price. It's one of those boards that you'll almost certainly find yourself reaching for time and again. □

**Above** □  
The two Qwiic-compatible STEMMA QT connectors mean you can daisy-chain this board with other sensors

**Below** □  
By default, the I/Os will operate at whatever voltage you supply, or you can use the jumper on the back to select 3.3V

## VERDICT

Does exactly what you'd expect it to.

9/10

issue

#51

ON SALE  
20 JANUARY

# ASSISTIVE TECHNOLOGY

## ALSO

- PCB DESIGN
- 3D PRINTING
- CIRCUITPYTHON
- LEDS
- AND MUCH MORE

DON'T MISS OUT

[hsmag.cc/subscribe](http://hsmag.cc/subscribe)

Next Issue



MAKE BUILD HACK CREATE

# HackSpace

TECHNOLOGY IN YOUR HANDS



**FREE  
SHIPPING**  
ON ORDERS OVER  
£33 OR \$50 USD\*



# Enabling the World's Ideas<sup>®</sup>

**0800 587 0991**  
**DIGIKEY.CO.UK**



**100,000+ new products added in past 90 days**

\*A shipping charge of £12.00 will be billed on all orders of less than £33.00. A shipping charge of \$18.00 USD will be billed on all orders of less than \$50.00 USD. All orders are shipped via UPS, Federal Express, or DHL for delivery within 1-3 days (dependent on final destination). No handling fees. All prices are in British pound sterling or United States dollar. Digi-Key is a franchised distributor for all supplier partners. New products added daily. Digi-Key and Digi-Key Electronics are registered trademarks of Digi-Key Electronics in the U.S. and other countries. © 2022 Digi-Key Electronics, 701 Brooks Ave. South, Thief River Falls, MN 56701, USA

**ECIA MEMBER**  
Supporting The Authorized Channel