

THE *Official*

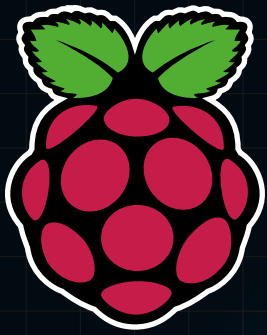

# RASPBERRY PI HANDBOOK

2021



Radio  
Globe



Magic  
Mirror



Reachy  
Robot



Hot  
Spotter Drone

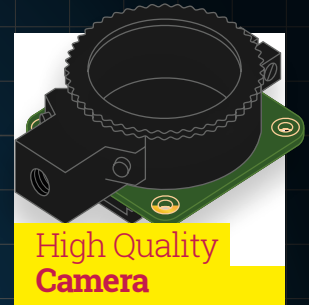
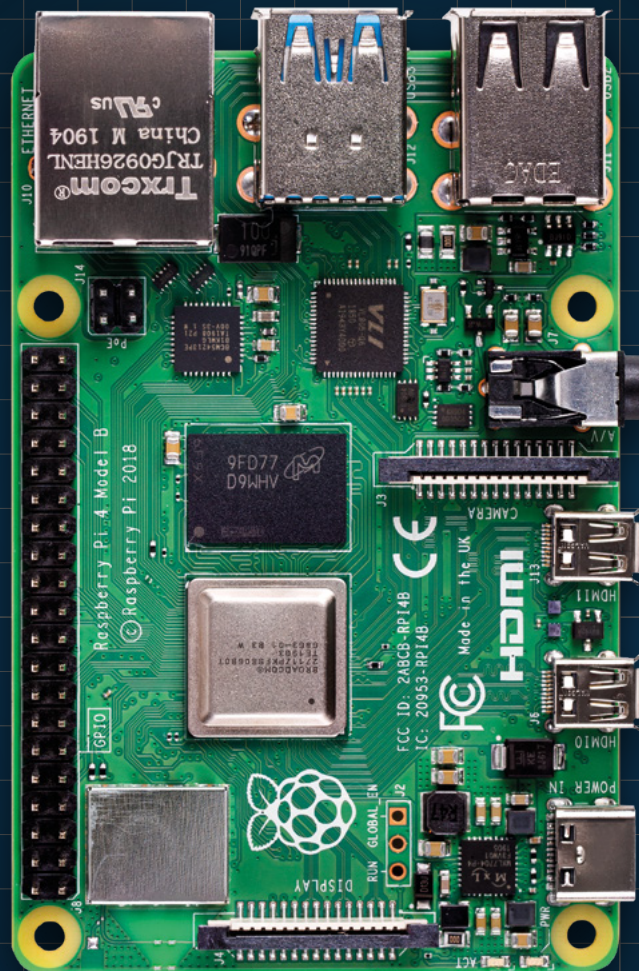

High Quality  
Camera

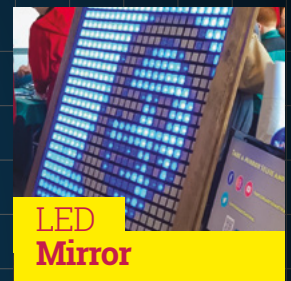

LED  
Mirror



Dual-screen  
Instaclock

Make amazing things  
with **Raspberry Pi**



Introducing  
**RASPBERRY PI 400**

FROM THE MAKERS OF *The MagPi* THE OFFICIAL RASPBERRY PI MAGAZINE

# American Raspberry Pi Shop

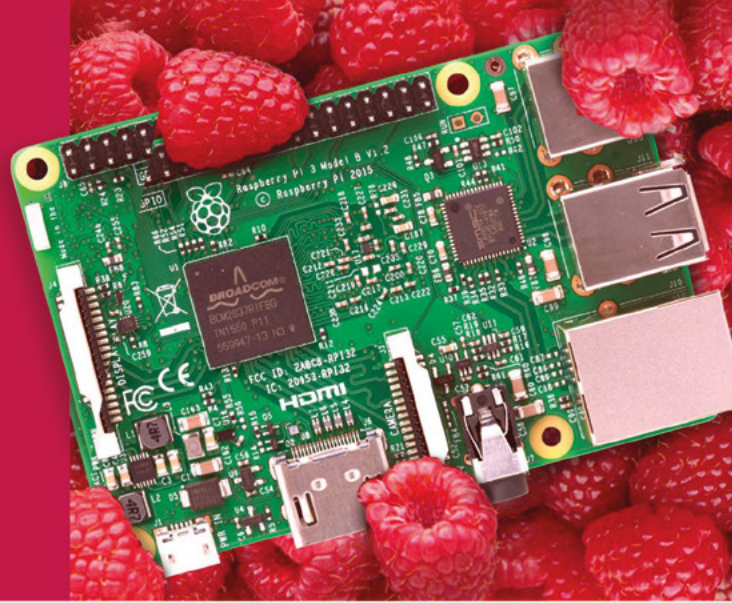

- Displays
- HATs
- Sensors
- Cases
- Arcade
- Swag
- Project Kits
- Cameras
- Power Options
- Add-on Boards
- Cables and Connectors
- GPIO and Prototyping

Partner and official reseller for top Pi brands:



and many  
others!

Price, service, design,  
and logistics support for  
**VOLUME PROJECTS**

USA



Canada



BuyaPi.ca

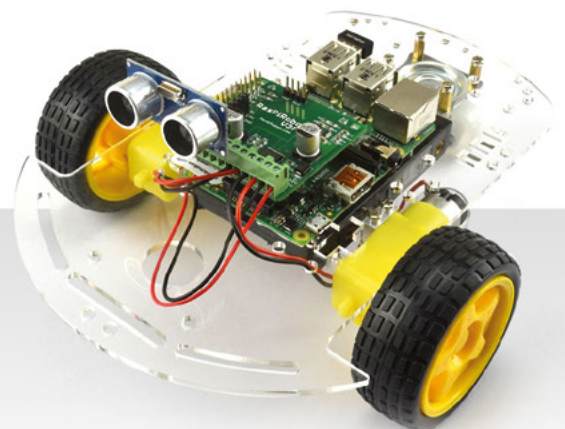

Raspberry Pi

APPROVED RESELLER

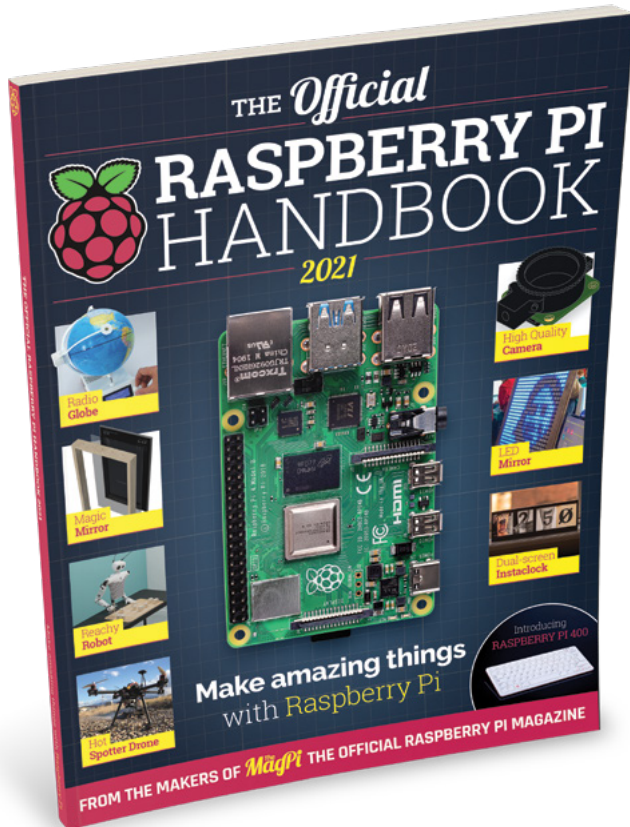

# WELCOME!

**A**s we reach a huge milestone with 100 issues of *The MagPi* magazine, we have more projects and guides than ever to choose from for this new *Official Raspberry Pi Handbook*. Squeezing in as many amazing projects as we could, we hope they provide great inspiration for your own makes.

The imagination and talent on show from the maker and Raspberry Pi community never ceases to amaze us. This book is a testament to just what people can do with a little knowledge and the perseverance to succeed, and I hope it inspires you for years to come.

If you're new to Raspberry Pi, then welcome! You've joined us at an exciting time with the release of Raspberry Pi 400, and you can still do amazing things with a standard Raspberry Pi model. We'll show you how to get yourselves set up, then you can find out exactly what you can do with your amazing new computer.

With that, I'll leave you all to enjoy the book. Happy making!

**Rob Zwetsloot**

**FIND US ONLINE** [magpi.cc](http://magpi.cc)

**GET IN TOUCH** [magpi@raspberrypi.com](mailto:magpi@raspberrypi.com)

**The MagPi**

Available on the  
**App Store**

GET IT ON  
**Google Play**

**CC BY NC SA**

## EDITORIAL

Editor: **Lucy Hattersley**  
Features Editor: **Rob Zwetsloot**  
Book Production Editor: **Phil King**  
Contributors: **David Crookes, PJ Evans, Gareth Halfacree, Rosie Hattersley, Nicola King, Simon Monk, Mark Vanstone**

## DISTRIBUTION

**Seymour Distribution Ltd**  
2 East Poultry Ave, London,  
EC1A 9PT | +44 (0)207 429 4000

## DESIGN

Critical Media: [criticalmedia.co.uk](http://criticalmedia.co.uk)  
Head of Design: **Lee Allen**  
Designers: **Sam Ribbits, James Legg**  
Illustrator: **Sam Alder**

## MAGAZINE SUBSCRIPTIONS

Unit 6, The Enterprise Centre,  
Kelvin Lane, Manor Royal,  
Crawley, West Sussex,  
RH10 9PE | +44 (0)207 429 4000  
[magpi.cc/subscribe](http://magpi.cc/subscribe)  
[magpi@subscriptionhelpline.co.uk](mailto:magpi@subscriptionhelpline.co.uk)

## PUBLISHING

Publishing Director: **Russell Barnes**  
[russell@raspberrypi.com](mailto:russell@raspberrypi.com)

Advertising: **Charlotte Milligan**  
[charlotte.milligan@raspberrypi.com](mailto:charlotte.milligan@raspberrypi.com)  
Tel: +44 (0)7725 368887

Director of Communications: **Liz Upton**  
CEO: **Eben Upton**



This bookazine is printed on paper sourced from sustainable forests and the printer operates an environmental management system which has been assessed as conforming to ISO 14001.

This official product is published by Raspberry Pi (Trading) Ltd., Maurice Wilkes Building, Cambridge, CB4 0DS. The publisher, editor and contributors accept no responsibility in respect of any omissions or errors relating to goods, products or services referred to or advertised in the magazine. Except where otherwise noted, content in this magazine is licensed under a Creative Commons Attribution-NonCommercial-ShareAlike 3.0 Unported (CC BY-NC-SA 3.0). ISBN: 978-1-912047-88-8.

# Contents

26



## Project Showcases

### 26 RadioGlobe

This globe rotates and plays a radio station for the selected location

### 32 WeatherMan

A classic Sony Walkman upcycled into a weather-predicting smart device

### 36 Pi Commander

Converting an old electronic toy into a retro games machine

### 38 Oktoberfest Pinball Machine

By the power of Raspberry Pi, you can play real pinball online

### 42 Astrophotography Autoguider

Keep your telescope steady to take perfect pictures of the night sky

### 46 Hot Spotter

An autonomous drone that can detect and report smouldering fires

### 50 Aquatic Mini Observation System

This solar-powered, autonomous boat measures water quality

### 52 Airdrum

This drum kit can be played with a hover of your hands

### 54 Cheeseborg

A dedicated, hands-free grilled cheese making robot

60



### 58 Bit Time – Rotary Dial Phone Project

Using two upcycled retro phones to explore how people communicate

### 60 NeoPixel LED Mirror

A magic mirror that shows you your reflection in LEDs

### 64 AdventurePi

Portable arcade project lets you choose your own adventure

### 66 Reachy

Meet this surprisingly expressive and flexible open-source robot

### 68 El Carrillon

Hacking the bells of an enormous tower to ring the changes

### 72 Bellagio Water Show

This miniature fountain features water jets synchronised to music

### 74 Raspberry Pine

The desktop computer with a wooden-framed display

### 76 Instaclock

A unique digital clock using two Raspberry Pi computers and screens

### 80 CNC Etch-A-Sketch

Using rotary encoders to control the knobs on a classic drawing toy

### 82 Solar-powered Raspberry Pi Camera

This home CCTV system is powered by the sun

06

## Get started with Raspberry Pi



### 06 QuickStart Guide

Step-by-step instructions to set up your Raspberry Pi

### 12 Introducing Raspberry Pi 400

Meet the brand new Raspberry Pi with integrated keyboard

### 18 Get Started with the High Quality Camera

Equip the HQ Camera with a lens and start shooting

42



86

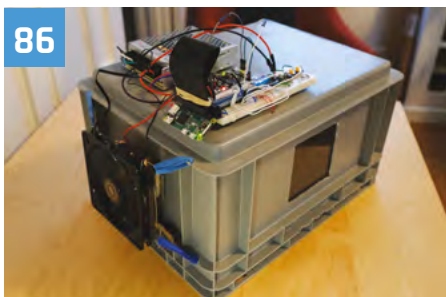

## 84 Flying Saucer Clock and NAS

An out-of-this-world way to tell the time and store your files

## 86 Chamber: Sourdough Incubator

Regulate the temperature of your sourdough starter to perfection

## 88 DropStitch

Creating amazing embroidery with wireless file transfer

## 90 RIoT Brick

Track a runner's progress with this portable sensing station

## 94 HAL 9000 Google Assistant

A voice assistant with the looks and personality of a film star!

## 98 Apollo Pi

Thermal sensing camera disguised as a 1970s microwave scanner

## 102 BeeMonitor

Keeping an eye on bee life cycles with Raspberry Pi

### Maker Guides

## 136 50 Raspberry Pi Tips and Tools

A huge range of physical and digital tools to improve your making skills

## 144 Starter Electronics with Raspberry Pi

If you bought a Raspberry Pi to learn how to make electronic gizmos, you're in for a treat

## 154 Build the Ultimate Magic Mirror

Everything you need to make this popular Raspberry Pi project

## 104 Giant Battleships

Play the classic board game on a giant LED matrix

## 106 Coffee Maker 'Greenhouse'

Upcycle an old coffee maker to water plants

## 108 Piano-Playing Robot

It can play scales, chords, and tunes and even read music

## 110 Singing Toilet

A choir of loo rolls start singing when the paper is pulled

## 112 Migration Museum

Celebrating the diversity of London with interactive artefacts

## 116 Project Zed

Sci-fi inspired large robot made from old printer parts

## 120 PiMowBot

Raspberry Pi-powered robotic lawn-mower

## 124 Retro gaming NES frame

Displaying pixel art on an old game cartridge

## 126 Black Lives Matter projection

Thought-provoking video projection powered by Raspberry Pi

## 130 The Swirl Machine

Make fantastic artworks by spinning and sloshing wine

## 174 Raspberry Pi Problems Solved

Diagnose and fix issues on your Raspberry Pi



136

### Reviews

## 186 M.A.R.S. Rover

Explore new territory with this sophisticated six-wheeled robot kit

## 188 SmartPi Touch 2

Smart-looking case for the discerning touchscreen user

## 189 Enviro

Environment-sensing board with a mini LCD screen

## 190 Argon Neo & Fan HAT

Stylish protective case with optional fan add-on

## 192 RedBoard+

Feature-packed robotics board with plenty of power

## 194 Unicorn HAT Mini

Versatile mini RGB LED matrix with bright pixels



## 195 HAT Hacker HAT

Two sets of 40 GPIO pins to connect multiple boards

## 196 RetroFlag GPi Case

Eighties handheld-inspired case with screen

## 197 Maker pHAT

A board to help you get started with physical computing

## 198 10 Best: Raspberry Pi cases

Keep your Raspberry Pi safe with these amazing cases

## 200 10 Best: Starter kits

Get started with your Raspberry Pi journey

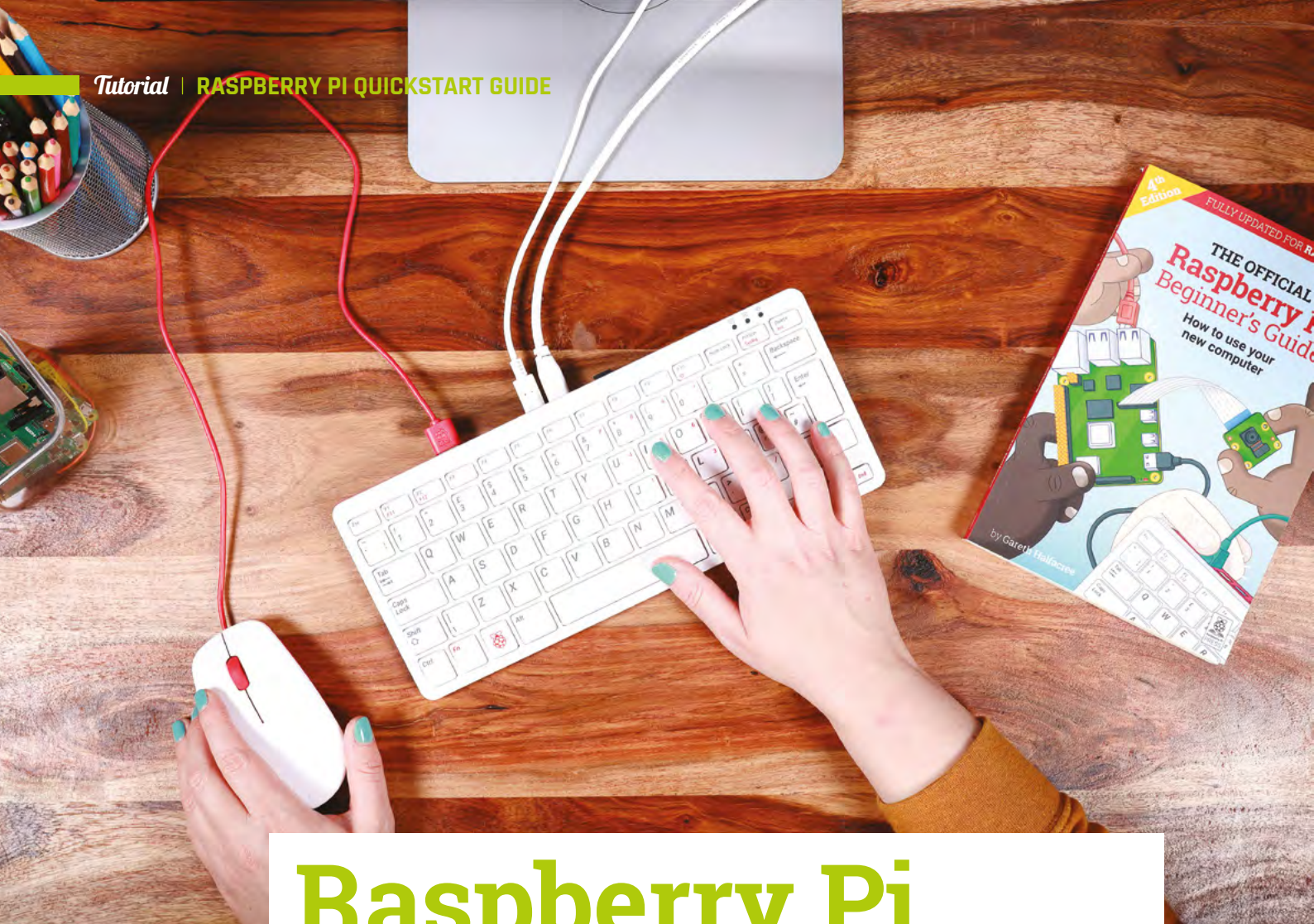

# Raspberry Pi QuickStart Guide

Setting up Raspberry Pi is pretty straightforward. Just follow the advice of **Rosie Hattersley**

**C**ongratulations on becoming a Raspberry Pi explorer. We're sure you'll enjoy discovering a whole new world of computing and the chance to handcraft your own games, control your own robots and machines, and share your experiences with other Raspberry Pi fanatics.

Getting started won't take long: just corral the extra bits and bobs you need on our checklist. Useful additions include some headphones or speakers if you're keen on using Raspberry Pi as a media centre or a gamepad for use as a retro games console.

To get set up, simply use your pre-written microSD card (or use Imager to set up a card) and connect all the cables. This guide will lead through each step. You'll find the Raspberry Pi OS, including coding programs and office software, all available to use. After that, the world of digital making with Raspberry Pi awaits you.

## What you need

**All the bits and bobs you need to set up a Raspberry Pi computer**

### A Raspberry Pi

Whether you choose the new Raspberry Pi 400; or a Raspberry Pi 4, 3B+, 3B, Pi Zero, Zero W, or Zero WH (or an older model of Raspberry Pi), basic setup is the same. All Raspberry Pi computers run from a microSD card, use a USB power supply, and feature the same operating systems, programs, and games.



### 8GB microSD card

You'll need a microSD card with a capacity of 8GB or greater. Your Raspberry Pi uses it to store games, programs, and boot the operating system. Many Raspberry Pi computer kits come with a card pre-written with Raspberry Pi OS. If you want to reuse an old card, you'll need a card reader: either USB or a microSD to full-sized SD (pictured).

### Raspberry Pi, Mac or PC computer

You'll need a computer to format the microSD card and copy Raspberry Pi OS. It doesn't matter what operating system this computer runs, because it's just for copying the files across.

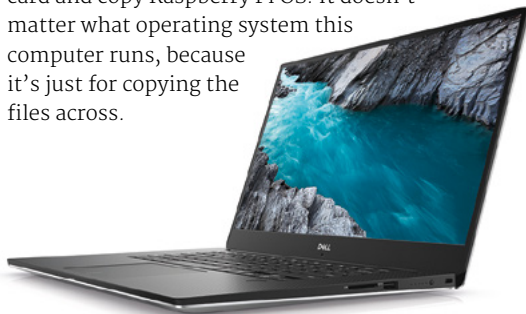

### USB keyboard

Like any computer, you need a means to enter web addresses, type commands, and otherwise control Raspberry Pi. The new Raspberry Pi 400 comes with its own keyboard. Raspberry Pi sells an official Keyboard and Hub ([magpi.cc/keyboard](https://www.raspberrypi.com/products/keyboard-and-hub)) for other models.

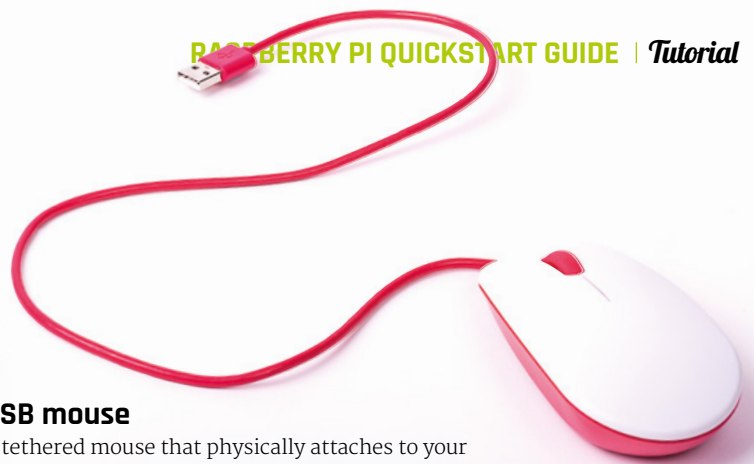

### USB mouse

A tethered mouse that physically attaches to your Raspberry Pi via a USB port is simplest and, unlike a Bluetooth version, is less likely to get lost just when you need it. Like the keyboard, we think it's best to perform the setup with a wired mouse. Raspberry Pi sells an Official Mouse ([magpi.cc/mouse](https://www.raspberrypi.com/products/official-mouse)).

### Power supply

Raspberry Pi 4 and Raspberry Pi 400 need a USB Type-C power supply. Raspberry Pi sells power supplies ([magpi.cc/usbcpower](https://www.raspberrypi.com/products/usb-c-power-supply)), which provide a reliable source of power. Raspberry Pi 1, 2, 3 and Zero models need a micro USB power supply ([magpi.cc/universalpower](https://www.raspberrypi.com/products/micro-usb-power-supply)).



### Display and HDMI cable

A standard PC monitor is ideal, as the screen will be large enough to read comfortably. It needs to have an HDMI connection, as that's what's fitted on your Raspberry Pi board. Raspberry Pi 4 and 400 can power two HDMI displays, but require a micro-HDMI to HDMI cable. Raspberry Pi 3B+ and 3A+ both use regular HDMI cables; Raspberry Pi Zero W needs a mini HDMI to HDMI cable (or adapter).



### USB hub

Raspberry Pi Zero and Model A boards have a single USB socket. To attach a keyboard and mouse (and other items) you should get a four-port USB hub (or use the official USB Keyboard and HUB keyboard with a hub built in). Instead of standard-size USB ports, Raspberry Pi Zero has a micro USB port (and usually comes with a micro USB to USB-A adapter).



The USB-C socket is used to connect power to the Raspberry Pi 400. You can use a compatible USB-C power adapter (found on recent mobile phones) or use a bespoke power adapter such as the Raspberry Pi 15.3W USB-C Power Supply.

The Ethernet socket can be used to connect Raspberry Pi 400 directly to a network router (such as a modem/router at home) and get internet access. Alternatively, you can choose a wireless LAN network during the welcome process.



## Set up Raspberry Pi 400

Raspberry Pi 400 has its own keyboard – all you need to connect is the mouse and power

### 01 Connect a mouse

Connect a wired USB mouse to the white USB connection on the rear of Raspberry Pi 400. The two blue USB 3.0 connectors are faster and best reserved for external drives and other equipment that need the speed.

### 02 Attach the micro-HDMI cable

Next, connect a micro-HDMI cable to one of the micro-HDMI sockets on the rear of Raspberry Pi 400. The one next the microSD card slot is the first one, but either connection should work. Connect the other end of the HDMI cable to an HDMI monitor or television.

### 03 The microSD

If you purchased a Raspberry Pi 400 Personal Computer Kit, the microSD card will come with Raspberry Pi OS pre-installed. All you need to do is connect the power and follow the welcome instructions. If you do not have a Raspberry Pi OS pre-installed microSD card, follow the instructions later in ‘Set up the software’.





# Set up Raspberry Pi

Raspberry Pi 4 / 3B+ / 3 has plenty of connections, making it easy to set up

## 01 Hook up the keyboard

Connect a regular wired PC (or Mac) keyboard to one of the four larger USB-A sockets on a Raspberry Pi 4 / 3B+ / 3. It doesn't matter which USB-A socket you connect it to. It is possible to connect a Bluetooth keyboard, but it's much better to use a wired keyboard to start with.

## 02 Connect a mouse

Connect a USB wired mouse to one of the other larger USB-A sockets on Raspberry Pi. As with the keyboard, it is possible to use a Bluetooth wireless mouse, but setup is much easier with a wired connection.

## 03 HDMI cable

Next, connect Raspberry Pi to your display using an HDMI cable. This will connect to one of the micro-HDMI sockets on the side of a Raspberry Pi 4, or full-size HDMI socket on a Raspberry Pi 3/3B+. Connect the other end of the HDMI cable to an HDMI monitor or television.

A HDMI cable, such as ones used by most modern televisions, is used to connect Raspberry Pi to a TV or display. You'll need a micro-HDMI to HDMI cable (or two) to set up a Raspberry Pi 4. Or a regular HDMI cable for Raspberry Pi 3B+ / 3 (or older) models.

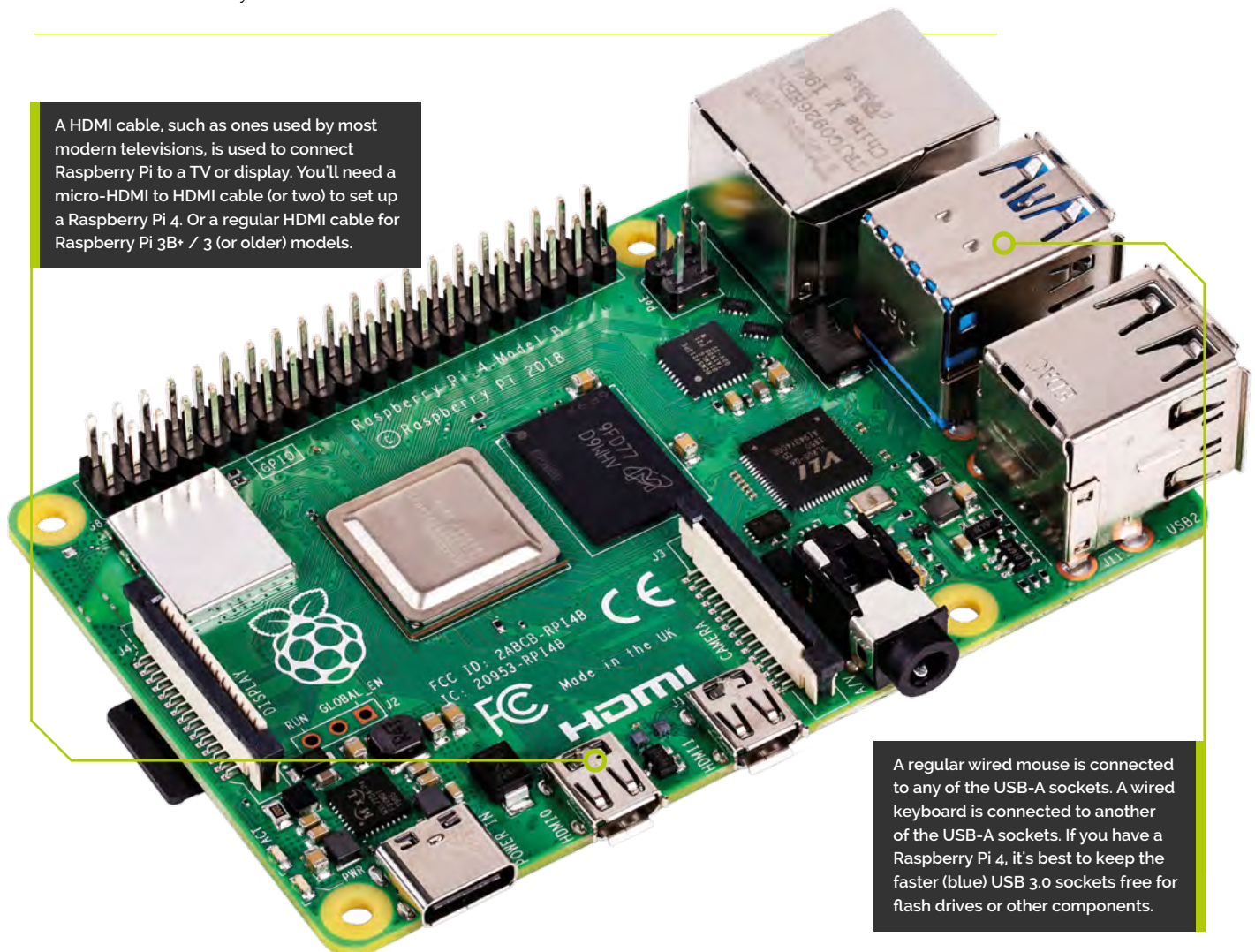

A regular wired mouse is connected to any of the USB-A sockets. A wired keyboard is connected to another of the USB-A sockets. If you have a Raspberry Pi 4, it's best to keep the faster (blue) USB 3.0 sockets free for flash drives or other components.

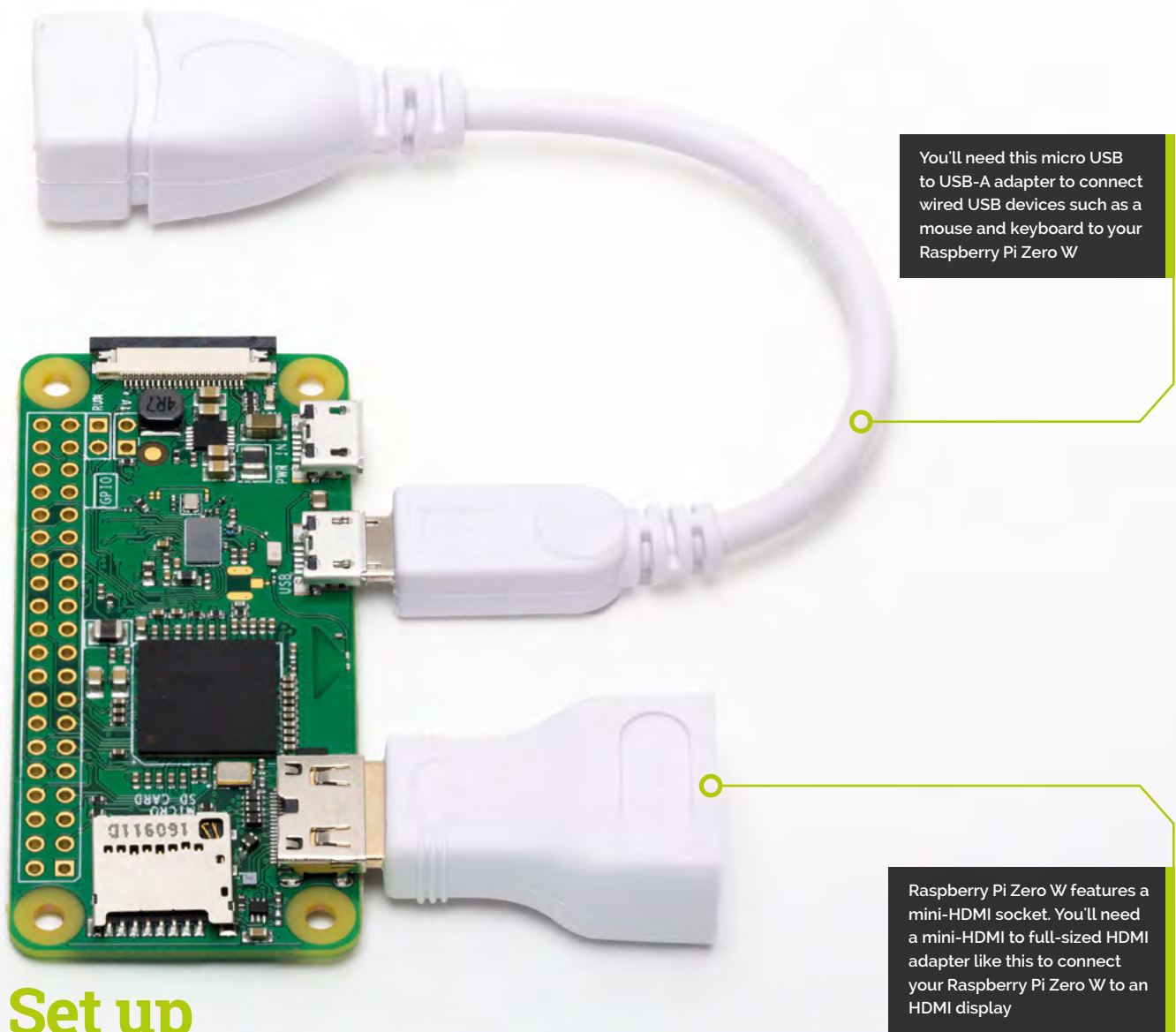

# Set up Raspberry Pi Zero

You'll need a couple of adapters to set up a Raspberry Pi Zero / W / WH

## 01 Get it connected

If you're setting up a smaller Raspberry Pi Zero, you'll need to use a micro USB to USB-A adapter cable to connect the keyboard to the smaller connection on a Raspberry Pi Zero W. The latter model has only a single micro USB port for connecting devices, which makes connecting both a mouse and keyboard slightly trickier than when using a larger Raspberry Pi.

## 02 Mouse and keyboard

You can either connect your mouse to a USB socket on your keyboard (if one is available), then connect the keyboard to the micro USB socket (via the micro USB to USB-A adapter). Or, you can attach a USB hub to the micro USB to USB-A adapter.

## 03 More connections

Now connect your full-sized HDMI cable to the mini-HDMI to HDMI adapter, and plug the adapter into the mini-HDMI port in the middle of your Raspberry Pi Zero W. Connect the other end of the HDMI cable to an HDMI monitor or television.

First, insert your microSD card into Raspberry Pi

With the microSD card fully inserted, connect your power supply cable to Raspberry Pi. A red light will appear on the board to indicate the presence of power

# Set up the software

Use Imager to install Raspberry Pi OS on your microSD card and start your Raspberry Pi

**N**ow you've got all the pieces together, it's time to install an operating system on your Raspberry Pi so you can start using it. Raspberry Pi OS is the official software for Raspberry Pi, and the easiest way to set it up on your Raspberry Pi is to use Raspberry Pi Imager.

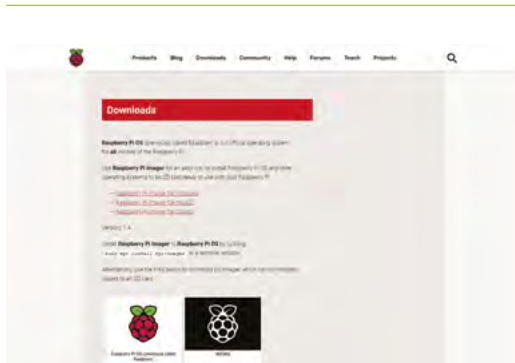

## 01 Download Imager

Raspberry Pi Imager is available for Windows, Mac, and Linux computers. You can also install it on Raspberry Pi computers, to make more microSD cards once you are up-and-running. Open a web browser on your computer and visit [magpi.cc/imager](http://magpi.cc/imager). Once installed, open Imager and plug your microSD card into your computer.

## 02 Choose OS

Click on 'Choose OS' in Raspberry Pi Imager and select Raspberry Pi OS (32-bit). Click 'Choose SD card' and select the microSD card you just inserted (it should say 8GB or the size of the card next to it). Click on 'Write'.

Your computer will take a few minutes to download the Raspberry Pi OS files, copy them to the microSD card, and verify that the data has been copied correctly.

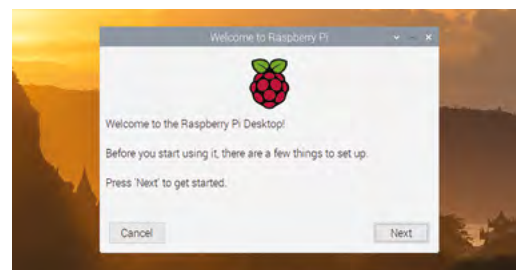
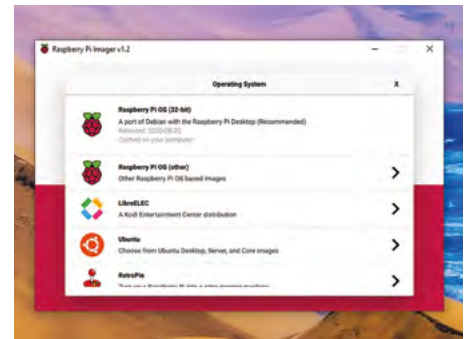

## 03 Set up Raspberry Pi

When Raspberry Pi Imager has finished verifying the software, you will get a notification window. Remove the microSD card and put it in your Raspberry Pi. Plug in your Raspberry Pi power supply and, after a few seconds, a blue screen will appear with 'Resizing Filesystem'. It will quickly vanish and be replaced by 'Welcome to Raspberry Pi'. Click on Next and follow the on-screen instructions to set up Raspberry Pi OS and start using your new computer.

### You'll Need

- ▶ A Windows/Linux PC or Apple Mac computer
- ▶ A microSD card (8GB or larger)
- ▶ A microSD to USB adapter (or a microSD to SD adapter and SD card slot on your computer)
- ▶ Imager [magpi.cc/imager](http://magpi.cc/imager)

```
print("Hello, World!")
```

# Raspberry Pi

An all-in-one system, **Raspberry Pi 400** is the only desktop you need

**W**hen is a keyboard not a keyboard? When it contains an entire personal computer. On the surface, Raspberry Pi 400 marks a return to the early days of personal computing, when bedroom programmers and office staff plugged all-in-one keyboards directly into their TVs and monitors for everything from gaming to coding.

Raspberry Pi 400 packs a measurable speed boost over Raspberry Pi 4, thanks to a clever passive cooling system which offers enough headroom for a processor jump from 1.5GHz to 1.8GHz.

Join us as we dive into the latest, and most impressive, Raspberry Pi ever made.

▣ Raspberry Pi 400 packs a measurable speed boost over Raspberry Pi 4" ▣

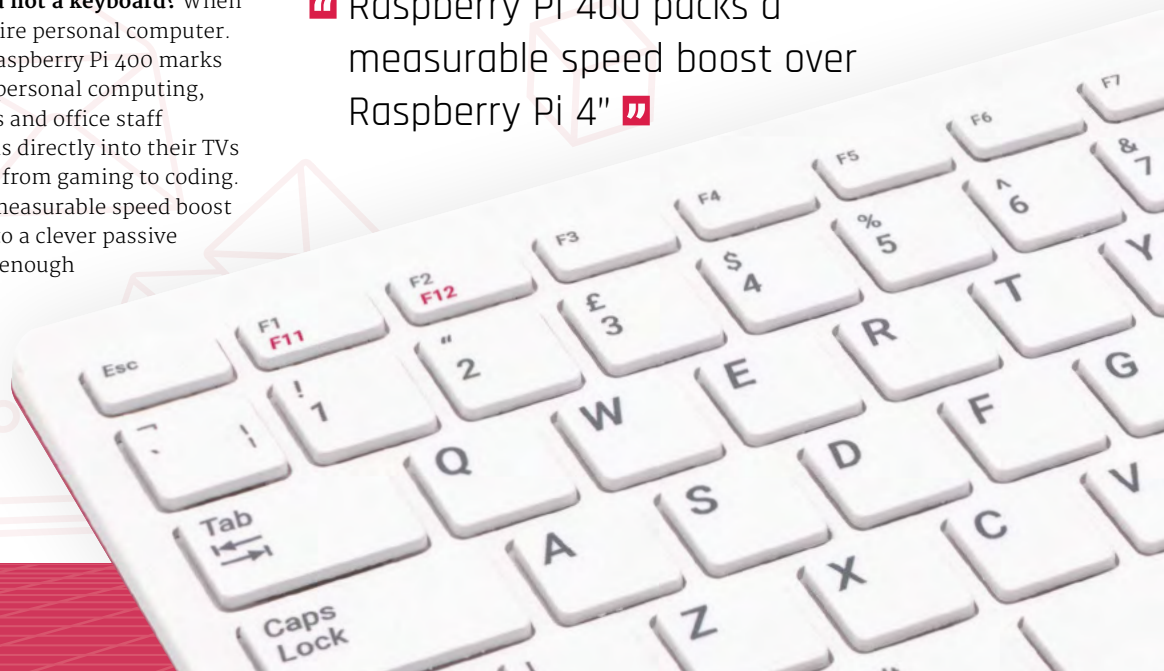

## Personal Computer Kit

You can buy Raspberry Pi 400 on its own, or as part of a Personal Computer Kit bundle with all the accessories you need. Inside the box you'll find:

- ▶ Raspberry Pi 400 computer
- ▶ USB mouse
- ▶ Power supply
- ▶ microSD card
- ▶ HDMI cable
- ▶ Beginner's Guide book



▶ Raspberry Pi 400 computers being built in the Sony factory in Pencoed, Wales



400

# PLACES TO BUY

## UK & Ireland



**Raspberry Pi Store**  
magpi.cc/retail-store



**The Pi Hut**  
thepihut.com



**CPC**  
cpc.farnell.com



**OKdo**  
okdo.com



**Pimoroni**  
pimoroni.com

## North America



**OKdo**  
okdo.com



**PiShop.us**  
pishop.us



**Adafruit**  
adafruit.com



**Newark**  
newark.com



**Micro Center**  
microcenter.com



**Canakit**  
canakit.com

## Europe



**OKdo**  
okdo.com



**Sertronic**  
digitec.ch



**Kiwi Electronics**  
kiwi-electronics.nl



**SEMAF**  
electronics.semaf.at



**Kubii**  
kubii.fr



**Totonic**  
pi-shop.ch



**Melopero**  
melopero.com



**Electrokit**  
electrokit.com



**pi3g**  
pi3g.com



**Jkollerup**  
raspberrypi.dk

## Asia



**element14**  
element14.com



**Cytron**  
cytron.io



**RS**  
rs-online.com



**Hangzhou Junroc**  
junroc.com



**Silverline**  
silverlineelectronics.in



**Beijing iVision**  
ivision-tech.world.taobao.com

For a full list of approved resellers, please go to [rpf.io/products](http://rpf.io/products)

```
print("Hello, World!")
```

# Meet Raspberry Pi 400

**O**n the first inspection, Raspberry Pi 400 is deceptively similar to the Raspberry Pi keyboard and hub. The rear of Raspberry Pi 400 tells a different story, with an array of sockets and connectors. Inside Raspberry Pi 400 is hardware based upon Raspberry Pi 4, but with a different design to reposition all the connections.

## Specifications

**PRICE:** £65 / \$70 (Raspberry Pi 400), £93.00 / \$100 (Raspberry Pi 400 Personal Computer Kit)

**SoC:** Broadcom BCM2711C0 quad-core A72 (ARMv8-A) 64-bit @ 1.8GHz

**GPU:** Broadcom VideoCore VI

**RAM:** 4GB LPDDR4 SDRAM

**NETWORKING:** 2.4GHz and 5GHz 802.11b/g/n/ac wireless LAN, Gigabit Ethernet

**BLUETOOTH:** Bluetooth 5.0, Bluetooth Low Energy (BLE)

**GPIO:** 40-pin GPIO header, populated

**STORAGE:** microSD

**PORTS:** 1× USB Type-C power input, 2× micro-HDMI 2.0, 1× USB 2.0, 2× USB 3.0, 1× RJ45 Ethernet, 1× Kensington locking slot

**COOLING:** Built-in passive heatsink

**DIMENSIONS:** 286 mm × 122 mm × 23.7mm, 385 g



### A GPIO PINS

The 40-pin GPIO header is used to connect Raspberry Pi 400 to electronic devices and to experiment with electronics and coding. Look closely and you'll see PIN1 and PIN40 imprinted on the case next to the first and last pin



### E USB 3.0

Two USB 3.0 sockets are used to connect devices to fast throughput, such as external storage drives



### F USB-A 2.0

A single USB 2.0 socket can be used with the mouse





**B MICRO SD CARD**

This push-click microSD socket acts as the main drive. A 16GB microSD card with Raspberry Pi OS pre-installed is included in the Personal Computer Kit



**C MICRO-HDMI**

Two micro-HDMI connectors are used to connect Raspberry Pi 400 to up to two 4K monitors



**D USB-C POWER**

Raspberry Pi 400 is powered via this USB-C Power connection using a Raspberry Pi 15.3W USB-C Power Supply (also included)



**G ETHERNET**

Gigabit Ethernet provides a fast direct network connection



**H KENSINGTON LOCK SOCKET**

Secure Raspberry Pi 400 to a table with the security lock socket



## Using HAT hardware with Raspberry Pi 400

Raspberry Pi 400 has the same 40-pin GPIO header as all current Raspberry Pi models. Only now it's positioned on the rear of the case.

You can connect HAT hardware directly to the 40-pin GPIO header, but it will be pointing backwards and down. A ribbon cable can be used to extend the GPIO pins and most will connect to Raspberry Pi 400 and extend with the pins facing upwards. You can pick up ribbon cables from The Pi Hut and other stores for around £3. Here we're using a 40-Pin GPIO Ribbon Cable – Rainbow 150 mm from The Pi Hut ([magpi.cc/ribboncable](http://magpi.cc/ribboncable)).



# Eben Upton and Simon Martin on Raspberry Pi 400

Raspberry Pi Foundation founder **Eben Upton** and principal hardware engineer **Simon Martin** wax lyrical about the new product

“It’s the most exciting product,” Raspberry Pi Foundation founder Eben Upton enthuses of Raspberry Pi 400’s birth. “Every now and then we do a product which brings together everything that we’ve learned, about technology and about business. Raspberry Pi 400 is another one of those summary products.

“I think it’s important to make beautiful things, and it’s just beautiful. It’s designed to be an object of desire. It just looks great.

“It’s faster than Raspberry Pi 4, and it’s thermally a lot better because it’s got more space and there’s some clever passive thermal design. So, although it runs 20% faster, it runs a lot cooler. That’s cool, but really, for me, it’s just the feel of it in your hand, the weight. It just feels like a consumer product, and it’s the first time we’ve ever made anything that’s like that.”



▲ Eben Upton, creator of Raspberry Pi and founder of Raspberry Pi Foundation

## Project Gamma

“I was hired at Raspberry Pi to do just such a product, back in summer 2017,” Raspberry Pi 400 designer Simon Martin explains. “At the time, Raspberry Pi 3 was the thing and I set about making a ‘Raspberry Pi 3 in a keyboard’ product.

“I think it’s important to make beautiful things, and it’s just beautiful”

“The project was called the Commodore 64 Project, and I thought, ‘Well, it’s a bit risky calling something the Commodore 64 Project, because everybody knows what we’re doing!’ So I took the letter C, in C64, and replaced it with Project Gamma, as in alpha, beta, gamma.

## What’s in a name?

“Somebody asked me, ‘Is it named after the Atari 400?’ I mean,” Eben explains, “it’s a nod to the ‘three-digit number that ends in zero’ as a pretty common naming convention with Atari, both 8-bit and 16-bit with the 520, Amiga with various hundreds, Acorn with the Archimedes 305s, 310s, 440s, yeah. It was a pretty common naming convention.

“It is obviously appealing that if, in the far future, we do a Raspberry Pi 5, then a Raspberry Pi 5 version will be called Raspberry Pi 500, which as an Amiga person is quite nice.

“It gives you a natural extension of the name scheme: we can still do plus models, we can still do major revisions, and it preserves the ‘if you don’t know anything about Raspberry Pi, get the largest number you can see’ rule.”





“It was clear it was going to be ready in production after Raspberry Pi 4 was announced, so we decided to move to Raspberry Pi 4. It was February last year I started work on making this Raspberry Pi 4-based Raspberry Pi 400 product.”

### Keeping cool

“I spent about six months working on the thermal side of it,” Simon continues. “That was the key to getting this thing to be a successful product: to make something that didn’t need any external cooling, it was going to deal with it itself. So, I spent a lot of time doing a thermal solution for it, and we came up with this metalwork inside it.

“If you see inside one, there’s a metal plate that runs across the entire board and keeps everything cool. I involved some consultants in thermal design, and they said that if the power consumption was, say, under 10 watts, then a passive cooling solution would be possible.

“Sure enough, there were some improvements to power draw that went on with Raspberry Pi 4 before it was announced, getting it down to the sort of 6 to 7 watt level. All of those improvements have kept the power budget to a useful level such that we can overclock Raspberry Pi 400 to 1.8GHz.”



▲ Simon Martin, Senior Principal Hardware Engineer at Raspberry Pi and designer of Raspberry Pi 400

## Pi Drop

“We’ve been doing bits of outreach to help kids who’ve been sent home from school with no computer,” says Eben. “It’s a programme called Pi Drop, that the Raspberry Pi Foundation is running.

“Ease of setup is very important to that customer base. It sounds trivial, but getting rid of Raspberry Pi, its case, and the cable between Raspberry Pi and the keyboard, it takes three things off the table.

“There’s also much less misconfiguration possibility with Raspberry Pi 400 than there is with Raspberry Pi 4. So we’ll be rolling over all of our charitable work from Raspberry Pi 4 to Raspberry Pi 400.”

# Get started with the High Quality Camera



Phil King

Phil is Raspberry Pi Press's books editor, as well as being a sub-editor and contributor for *The MagPi*.

[magpi.cc](http://magpi.cc)

Find out how to set up the new Raspberry Pi camera, connect it, and take your first shots and videos

**T**he new Raspberry Pi High Quality Camera (HQ Camera for short) can capture higher-resolution images than the standard Camera Module. Unlike the latter, it doesn't have a lens already attached. Instead, it can be used with any standard C- or CS-mount lens; 6 mm and 16 mm lenses are available to purchase with the camera to help you get started.

In this tutorial, we'll show you how to attach a lens to the HQ Camera and adjust its focus and aperture settings. We'll then use the supplied ribbon cable to connect it to Raspberry Pi, enable it in Raspbian, and enter some commands in a Terminal window to start capturing photos and video.

## Using the 6 mm CS-mount lens

A low-cost 6 mm lens is available for the HQ Camera. This lens is suitable for basic photography. It can also be used for macro photography because it can focus objects at very short distances.



### You'll Need

- ▶ Raspberry Pi High Quality Camera and lens  
[magpi.cc/hqcamera](http://magpi.cc/hqcamera)

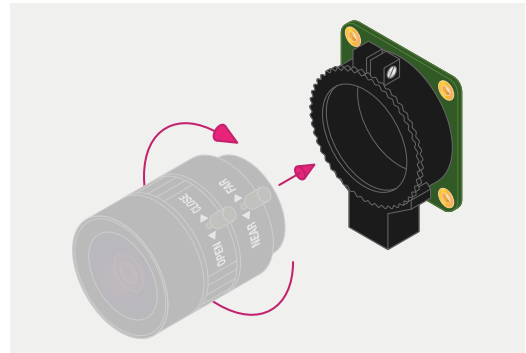

### 01 Fit the lens to the camera

The lens is a CS-mount device, so it has a short back focus and does not need the C-CS adapter that comes with the HQ Camera. Rotate the lens clockwise all the way into the back focus adjustment ring.

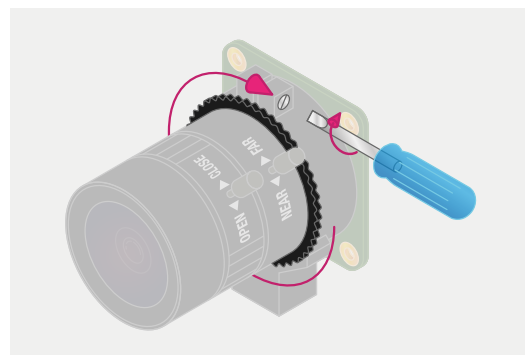

### 02 Back focus adjustment ring

The back focus adjustment ring should be screwed in fully for the shortest possible back-focal length. Tighten the back focus lock screw to

make sure it does not move out of this position when adjusting the aperture or focus.

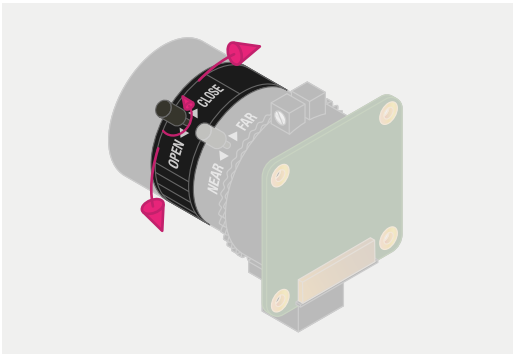

### 03 Adjust aperture

Hold the camera with the lens facing away from you. Turn the middle ring while holding the outer ring, furthest from the camera, steady. Turn clockwise to close the aperture and reduce image brightness. Turn anti-clockwise to open the aperture. Tighten the screw to lock the setting.

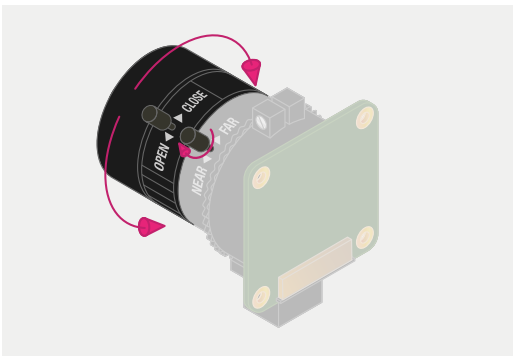

### 04 Adjust focus

First, lock the inner focus ring, labelled 'NEAR ◀▶ FAR', in position by tightening its screw. Now hold the camera with the lens facing away from you. Hold the outer two rings of the lens and turn them both clockwise until the image comes into focus – it'll take four or five whole turns. To adjust focus, turn the outer two rings clockwise to focus on a nearby object. Turn them anti-clockwise to focus on a distant object. You may need to adjust the aperture again after this.

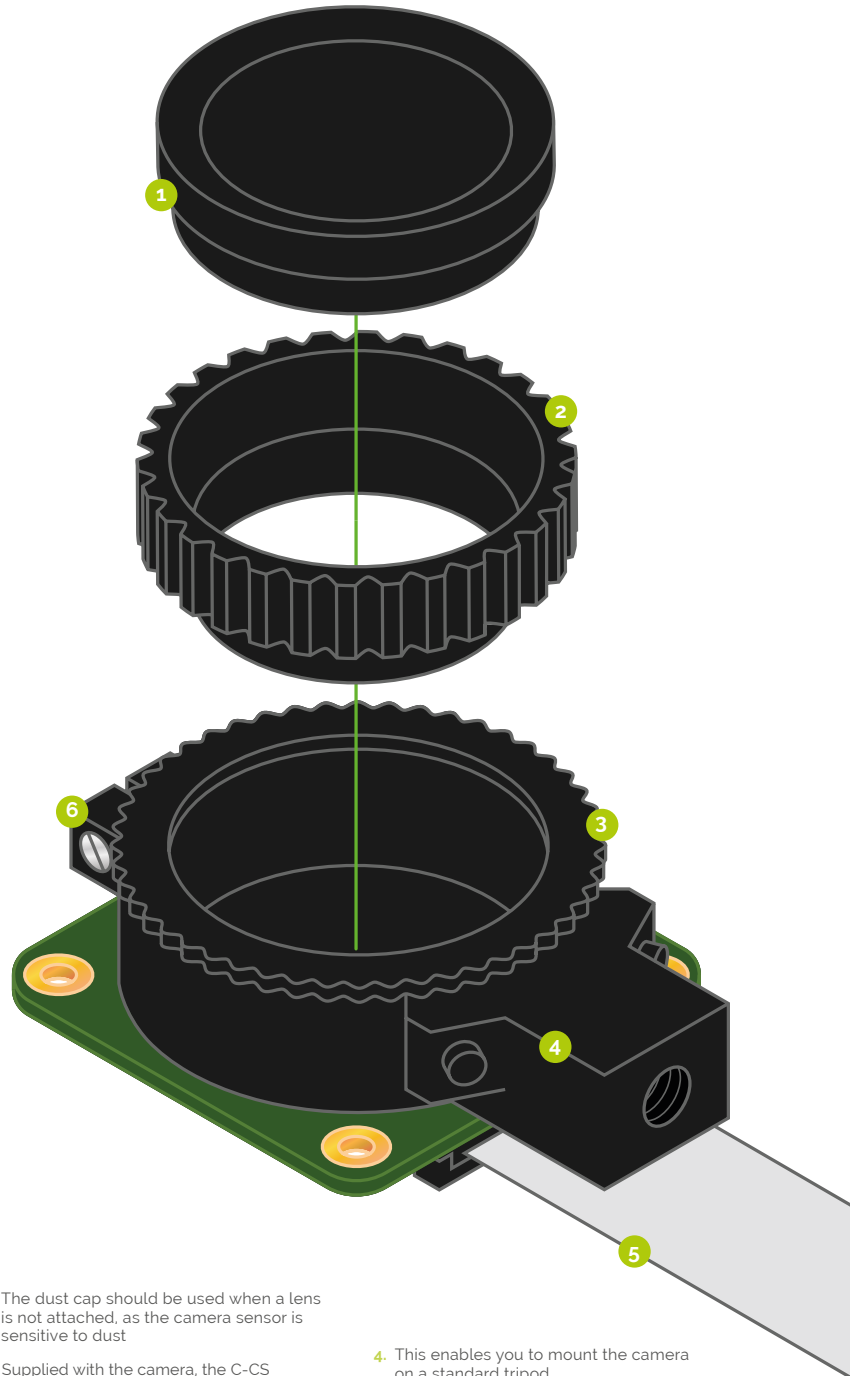

1. The dust cap should be used when a lens is not attached, as the camera sensor is sensitive to dust

2. Supplied with the camera, the C-CS adapter should be used when attaching a C-mount lens

3. The back focus adjustment ring can be used to alter the focus when using a fixed-focus lens, or to change the focal range of an attached adjustable-focus lens

4. This enables you to mount the camera on a standard tripod

5. The camera is supplied with a 20 cm ribbon cable to connect it to Raspberry Pi's Camera port

6. Tighten this screw to lock the back focus adjustment ring in position



## Using the 16 mm C-mount lens

The 16 mm lens provides a higher-quality image than the 6 mm lens. It has a narrow angle of view which is more suited to viewing distant objects.

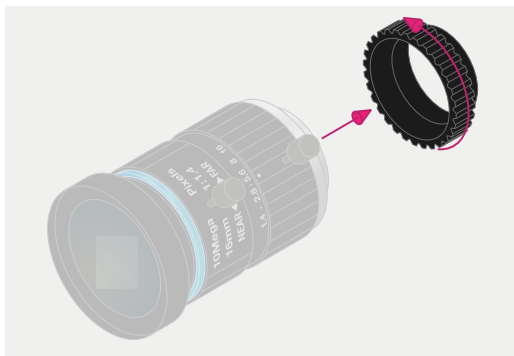

- 01 Fit the C-CS adapter**  
Ensure the C-CS adapter that comes with the HQ Camera is fitted to the lens. The lens is a C-mount device, so it has a longer back focus than the 6 mm lens and therefore requires the adapter.

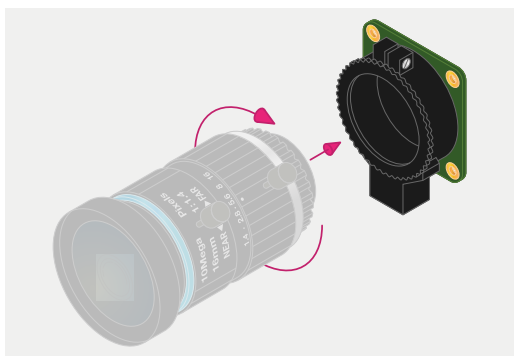

- 02 Fit the lens to the camera**  
Rotate the lens and C-CS adapter clockwise all the way into the back focus adjustment ring.

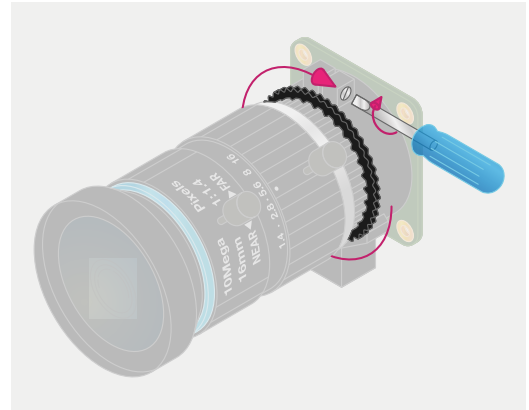

- 03 Back focus adjustment ring**  
The back focus adjustment ring should be screwed in fully. Tighten the back focus lock screw to make sure it does not move out of this position when adjusting the aperture or focus.

- “Tighten the back focus lock screw to make sure it does not move out of this position”

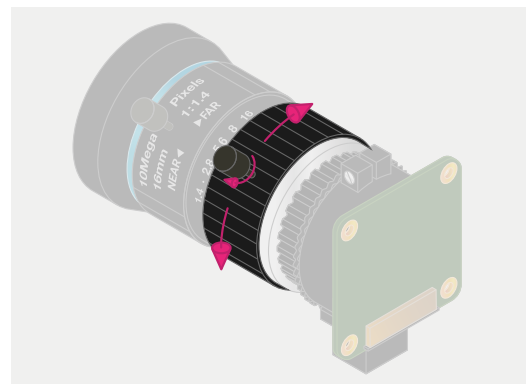

- 04 Adjust aperture**  
To adjust the aperture, hold the camera with the lens facing away from you. Turn the inner ring, closest to the camera, while holding the camera steady. Turn clockwise to close the aperture and reduce image brightness. Turn anti-clockwise to open the aperture. Once you are happy with the light level, tighten the screw on the side of the lens to lock the aperture ring into position.

### Top Tip

#### Longer cable

The HQ Camera is supplied with a standard 20 cm ribbon cable for connection to Raspberry Pi. However, longer camera cables are available from the usual online retailers.

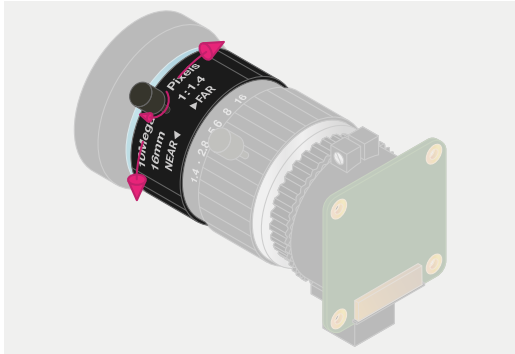

## 05 Adjust focus

To adjust the focus, hold the camera with the lens facing away from you. Turn the focus ring, labelled 'NEAR ◀▶ FAR', anti-clockwise to focus on a nearby object. Turn it clockwise to focus on a distant object. You may find you need to adjust the aperture again after this.

## Connecting and using the camera

With your HQ Camera and mounted lens ready, it's time to connect it to your Raspberry Pi and start capturing some images.

### 01 Connect ribbon cable to camera

On the bottom of the HQ Camera board, you'll find a black plastic flap (**Figure 1**). Carefully pull the sticking-out edges until the flap pulls part-way out. Slide the ribbon cable, with the silver edges downwards and the blue plastic facing upwards, under the flap you just pulled out, then push the flap gently back into place with a click; it doesn't matter which end of the cable you use. If the cable is installed properly, it will be straight and won't come out if you give it a gentle tug; if not, pull the flap out and try again.

### 02 Connect cable to Raspberry Pi

Find the Camera port on Raspberry Pi and pull the plastic flap gently upwards. With Raspberry Pi positioned so the HDMI port is facing you, slide the ribbon cable in so the silver edges are to your left and the blue plastic to your right, then gently push the flap back into place. As before, if the cable is installed properly, it'll be straight and won't come out if you give it a gentle tug; if not, pull the plastic flap out and reinsert the cable.

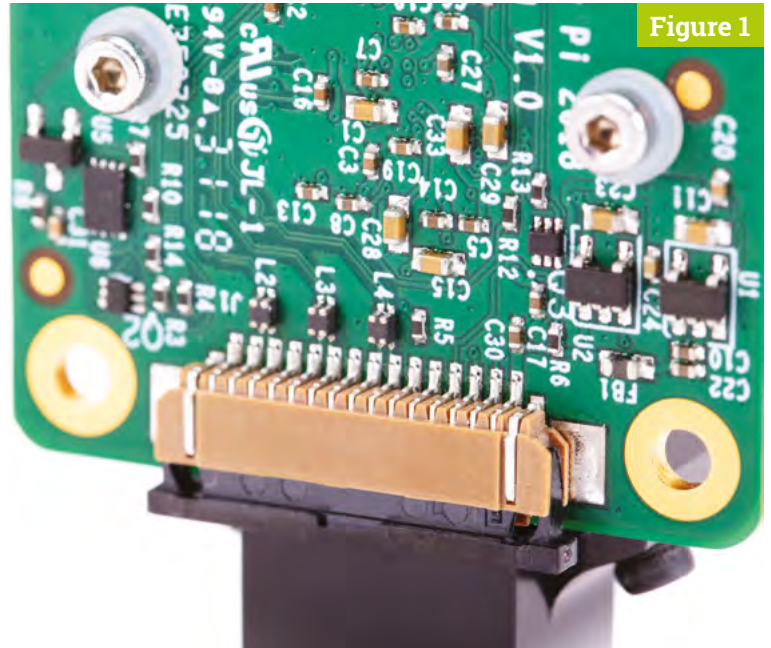

Figure 1

If using a Raspberry Pi Zero, its Camera port is found on the edge of the board. However, as it's a smaller size than the regular one on other Raspberry Pi models, you'll need a camera adapter cable to use it ([magpi.cc/zerocamcable](http://magpi.cc/zerocamcable)).

### 03 Enable the camera

Connect the power supply back to Raspberry Pi and let it load Raspbian. Before you can use the camera, you'll need to tell Raspberry Pi it has one connected: in the Raspbian menu, select Preferences, then Raspberry Pi Configuration. When the tool has loaded, click the Interfaces tab, find the Camera entry in the list, and click on the round radio button to the left of 'Enabled' to switch it on (**Figure 2**, overleaf). Click OK, and the tool will prompt you to reboot your Raspberry Pi. Do so and your camera will be ready to use.

### 04 Test the camera

To confirm that your camera is correctly installed, you can use the `raspistill` tool. This, along with `raspivid` for videos, is designed to capture images from the camera using Raspberry Pi's command-line interface (CLI). In the Raspbian menu, select Accessories, then Terminal. A black window with green and blue writing in it will

## Top Tip

Permanent preview

To keep the preview window showing on screen, then take a photo whenever the **ENTER** key is pressed, use this command:  
`raspistill -t 0 -k -o my_pics%02d.jpg.`  
 Press **CTRL+C** to exit.

## Top Tip

### Using VNC

By default, you won't be able to view the camera preview window when accessing your Raspberry Pi remotely from another computer via VNC. However, there is a setting to make the window appear. Open the VNC Server menu on Raspberry Pi and go to Options > Troubleshooting, then select 'Enable direct capture mode'.

appear: this is the Terminal, which allows you to access the command-line interface.

To take a test shot, type the following into the Terminal:

```
raspistill -o test.jpg
```

As soon as you hit **ENTER**, you'll see a large picture of what the camera sees appear on-screen (**Figure 3**). This is called the live preview and, unless you tell raspistill otherwise, it will last for five seconds. After those five seconds are up, the camera will capture a single still picture and save it in your home folder under the name **test.jpg**. If you want to capture another, type the same command again – but make sure to change the output file name, after the **-o**, or you'll save over the top of your first picture.

Figure 2

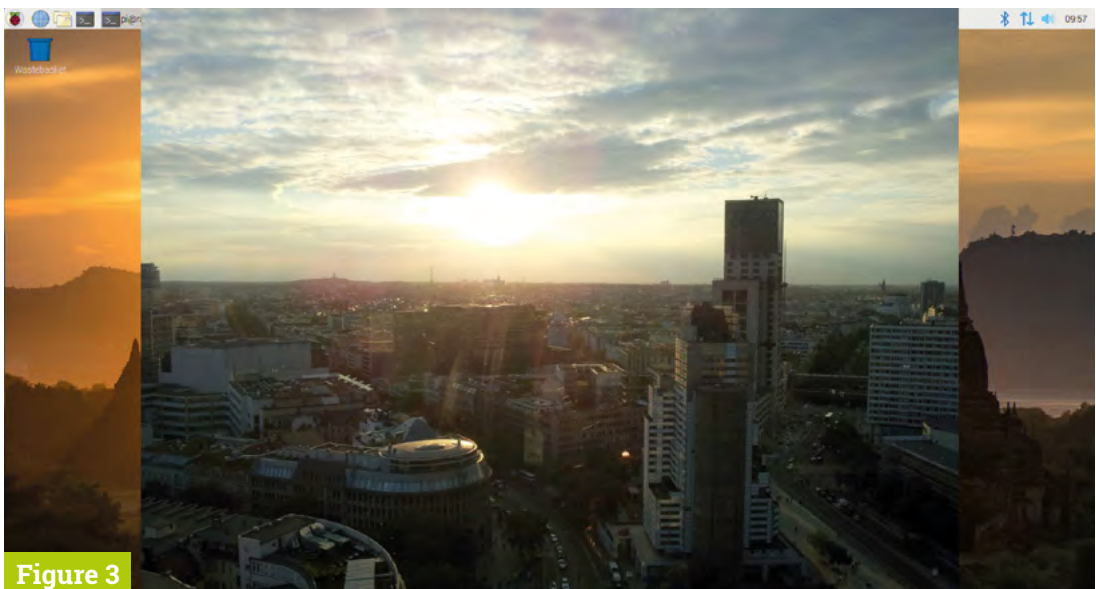
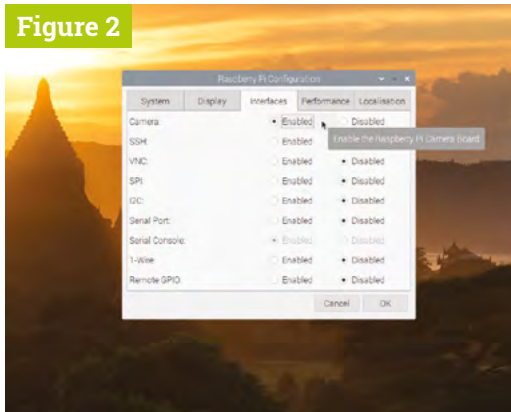

Figure 3

## 05 More advanced commands

The raspistill command has a list of options so long that it borders on the intimidating. Have no fear, though: you won't need to learn them all, but there are a few that might be useful to you, such as:

```
raspistill -t 15000 -o newpic.jpg
```

The **-t** option changes the delay before the picture is taken, from the default five seconds to whatever time you give it in milliseconds – in this case, you have a full 15 seconds to get your shot arranged perfectly after you press **ENTER**.

## 06 Capture video

For shooting video, raspivid is what you need. Try it out with this Terminal command:

```
raspivid -t 10000 -o testvideo.h264
```

This records a ten-second video (10,000 milliseconds) at the default 1920 × 1080 resolution. You can also shoot slow-mo video at 640 × 480 by using:

```
raspivid -w 640 -h 480 -fps 90 -t 10000 -o test90fps.h264
```

You can use VLC to play the videos back. This application is pre-installed in the Raspbian 'Full' version. If it's not, you can use the Recommended Software tool to install it. [M](#)



*The* **MagPi**

**HackSpace**  
TECHNOLOGY IN YOUR HANDS

**CUSTOMPC**

**3 ISSUES FOR £10**



**FREE BOOK**



[magpi.cc/freebook](http://magpi.cc/freebook)

Subscribe to The MagPi, HackSpace magazine, or Custom PC. Your first three issues for £10, then our great value rolling subscription afterwards. Includes a free voucher for one of five fantastic books at [store.rpiexpress.com/collections/latest-bookazines](http://store.rpiexpress.com/collections/latest-bookazines)  
UK only. Free delivery on everything.

# Project Showcases



## 26 RadioGlobe

This globe rotates and plays a radio station for the selected location

## 32 WeatherMan

A classic Sony Walkman upcycled into a weather-predicting smart device

## 36 Pi Commander

Converting an old electronic toy into a retro games machine

## 38 Oktoberfest Pinball Machine

By the power of Raspberry Pi, you can play real pinball online

## 42 Astrophotography Autoguider

Keep your telescope steady to take perfect pictures of the night sky

## 46 Hot Spotter

An autonomous drone that can detect and report smoldering fires

## 48 Aquatic Mini Observation System

This solar-powered, autonomous boat measures water quality

## 52 Airdrum

This drum kit can be played with a hover of your hands

## 54 Cheeseborg

A dedicated, hands-free grilled cheese making robot

## 58 Bit Time – Rotary Dial Phone Project

Using two upcycled retro phones to explore how people communicate

## 60 NeoPixel LED Mirror

A magic mirror that shows you your reflection in LEDs

## 64 AdventurePi

Portable arcade project lets you choose your own adventure

## 66 Reachy

Meet the expressive and flexible open-source robot

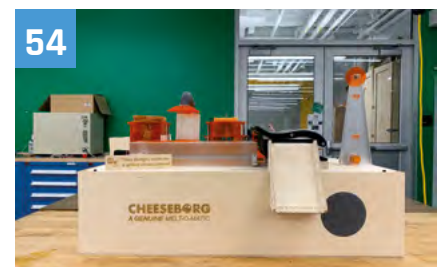



78

**68 El Carrillon**

Hacking the bells of an enormous tower to ring the changes

**72 Bellagio Water Show**

This miniature fountain features water jets synchronised to music

**74 Raspberry Pine**

The desktop computer with a wooden-framed display

**76 Instaclock**

A unique digital clock using two Raspberry Pi computers and screens

**80 CNC Etch-A-Sketch**

Using rotary encoders to control the knobs on a classic drawing toy

**82 Solar-powered Raspberry Pi Camera**

This ingenious home CCTV system is powered by the sun

**84 Flying Saucer Clock and NAS**

An out-of-this-world way to tell the time and store your files

**86 Chamber: Sourdough Incubator**

Regulate the temperature of your sourdough starter

**88 DropStitch**

Creating amazing embroidery with wireless file transfer

**90 RiOT Brick**

Track a runner's progress with this portable sensing station

**94 HAL 9000 Google Assistant**

A voice assistant with the looks and personality of a film star!

**98 Apollo Pi**

Thermal sensing camera disguised as a 1970s microwave scanner

**102 BeeMonitor**

Keeping an eye on bee life cycles with Raspberry Pi

**104 Giant Battleships**

Play the classic board game on a giant LED matrix

124



84



120

**106 Coffee Maker 'Greenhouse'**

Upcycle an old coffee maker to irrigate pot plants

**108 Piano-Playing Robot**

It can play scales, chords, and tunes and even read sheet music

**110 Singing Toilet**

A choir of loo rolls start singing when the paper is pulled

**112 Migration Museum**

Celebrating the diversity of London's residents with interactive artefacts

**116 Project Zed**

Sci-fi inspired robot made from old printer parts

**120 PiMowBot**

Raspberry Pi-powered robotic lawn-mower

**124 Retro gaming NES frame**

Displaying pixel art on an old game cartridge

**126 Black Lives Matter projection**

Thought-provoking video projection powered by Raspberry Pi

**130 The Swirl Machine**

Make fantastic art by spinning and sloshing wine

# RadioGlobe

Want to know what's playing on the radio anywhere in the world? **Rob Zwetsloot** goes on tour with RadioGlobe



**Jude Pullen**

Self-proclaimed 'prototyping expert' and 'technologist' with an impressive resume of work designing concepts for Dyson, Sugru, Lego, DesignSpark, and even TV.

[magpi.cc/radioglobe](http://magpi.cc/radioglobe)



## Alert! Drill safety

Please use safety goggles and a desk clamp when drilling.

[magpi.cc/drillsafety](http://magpi.cc/drillsafety)

**P**eople sometimes ask us 'why?' when we share projects online. Why make something that already exists in an easier format, or isn't very functional? The simple answer is: because we can. It can be very fun to make stuff, and the RadioGlobe is an excellent example of this.

"It's a globe which you spin to search web radio stations," creator Jude Pullen summarises. "It's really simple to use (even my four-year-old son gets it!), but the tech inside is pretty clever to make it work. It has a very special component called a rotary encoder, which has the ability to know the position of a rotating axis (in this case the longitude and latitude) to an accuracy of 0.3 degrees. It means we can navigate to all the major cities in the world and listen to their local stations."

## Bringing radio to life

The idea for the project arose through a combination of concepts that were on Jude's mind at once. "I think I'd been reading books about space travel, and the emergence of communications while working on a Channel 4 show called *David Jason's Great British Inventions*," he says. "My job was to build a replica of the Bell telephone (using some scrap wood, piping, wires, tracing paper, and vinegar!), and it kinda blew my mind to consider the advent of this technology in the world. This led me to explore a lot of technology we take for granted, like radio. I was discussing this with a friend who then mentioned a website called RadioGarden [[radio.garden](http://radio.garden)] which allows you to look up all radio stations on Google Earth. It's a clever mash-up of two powerful technologies, and I guess my 'build' on this was to make it physical."

Information about where you're pointing and what radio station you're listening to are listed on the display





The rotary encoders are set so they know the position of the reticule over the globe

Quick FACTS

- ▶ Jude usually works with Arduino, but Raspberry Pi was more suited to this project
- ▶ The basic design was created in cardboard first...
- ▶ ... before being 3D-printed in Jude's home workshop
- ▶ Jude's friend Don Robson helped with the code
- ▶ The rotary encoders remember where they are when you next turn it on!

The globe spins just like a toy version!

16.86N, 99.88W  
 Acapulco, MX  
 < XHKJ Radio Vida >

RADIOGLOBE DESIGNSPARK RS

- ▶ Just a few of the tools and items you need to build such a device
- ▼ A Raspberry Pi and all the other main electronics are stored in the base

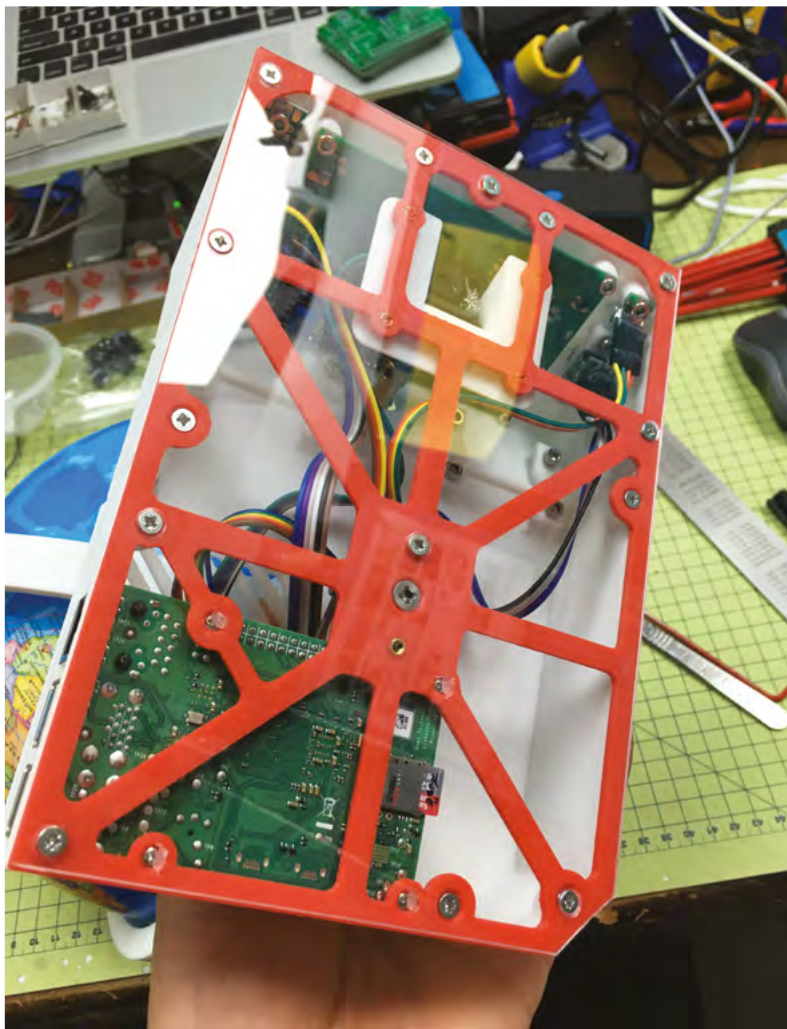

### Proof is in the concept

The world is a big place – Jude tells us there are 44,000 radio stations around the world, and not all of them have great broadcast quality. For what he’s managed to achieve, he seems pretty happy, though.

“There is a phrase in design called ‘proof of concept’ or in code it’s sometimes called ‘minimum viable product,’” he notes. “RadioGlobe is that in terms of its physical design (3D-printed)

“ We can navigate to all the major cities in the world and listen to their local stations ”

and code (V1.0 on GitHub). It works really well in that most of the 2000-odd radio stations do play, but yes there are bugs – in that some radio station links are in countries where broadcast is not perfect, so this can ‘trip up’ the code, and it stops playing.”

Jude has some updates in the works for the RadioGlobe, some of which sound fairly obvious and genuinely useful, such as a recall function for favourites in case you stumble upon a K-pop station you really like, as well as a Shazam button to identify the latest Austrian hit.

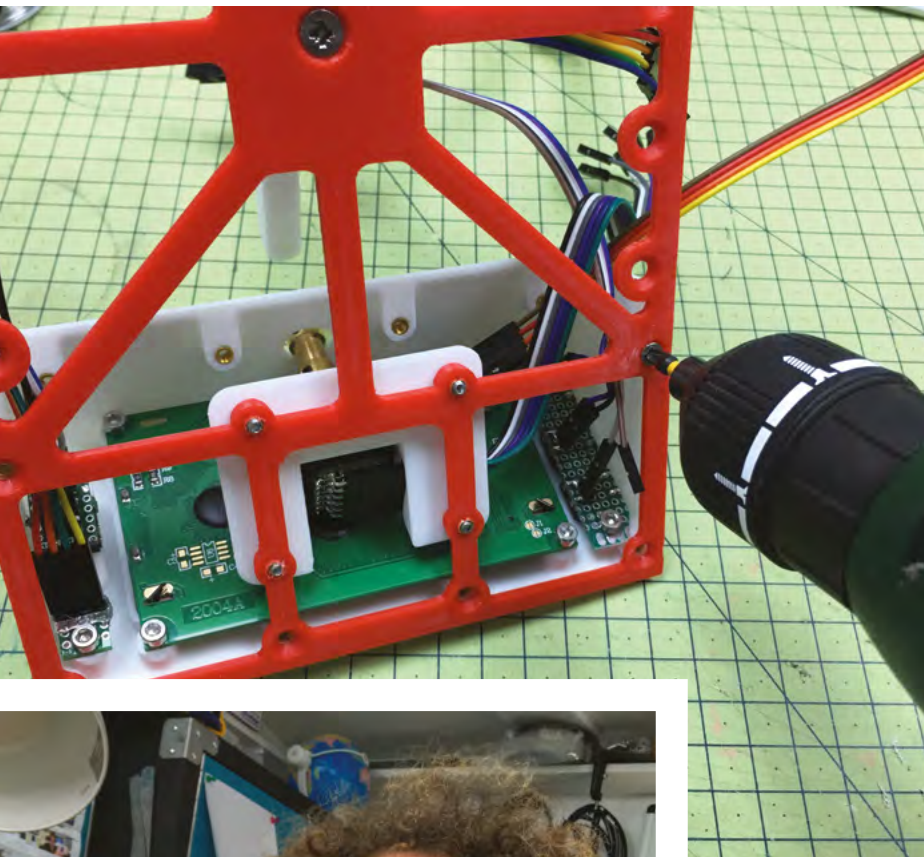

- ▲ The electronics are hidden from the top but visible from below
- ◀ Final adjustments

## Find a radio station



- 01 Spin the globe – this is your longitude control – to get to a rough area. Then use the arm to centre the reticule on an exact location. A light will turn from flashing white to red when it's got a location.

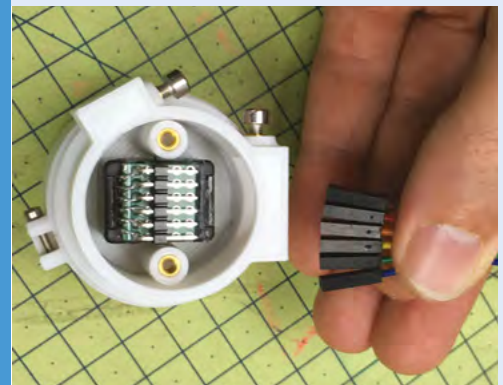

- 02 Two rotary encoders are used to determine the position of the reticule on the globe (that longitude and latitude again), which checks against locations. This turns the light to red when it syncs up with somewhere with playable radio stations.



- 03 You can scroll through a list of stations at the location, but otherwise it will display what the station is on the screen and start playing from it.

“This is possible because the project is open source, and the code can be contributed to be total strangers from around the world,” Jude explains. “I love the poetic-loop of this! And this has very much been the best of my experience in working with exciting companies like DesignSpark and Raspberry Pi who have championed new ideas that literally might come from anyone, anywhere in the world. Perhaps we’ll have RadioUniverse one day! I joke, but of course RadioGlobe would have seemed crazy 100 years ago too.” [M](#)



- ▲ Attaching the globe is one of the final steps
- ▶ Some modification of the globe is required
- ▼ We'll excuse Jude for saying it's "child's play" to use because, well, he's right





STRIKE | ATTACK  
FAST | STRONG

Coollest Cases.  
Fastest Raspberry Pi ever.



Argon ONE  
M.2

The Argon ONE M.2 Case ups the ante by providing Two full-sized HDMI ports, Power Management Modes, Built-in IR support, Integrated M.2 SATA SSD support through the USB 3.0 Ports of Raspberry Pi 4.

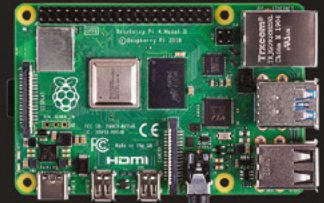

www.argon40.com



POLY+  
W/ MINI FAN



ARGON NEO



ARGON ONE  
PI 4 V2

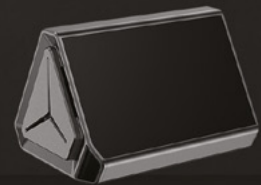

ARGON PI NAS  
(COMING SOON)

MADE IN AFRICA



PROUDLY SERVING

AFRICA

RASPBERRY PI and lots more

SINCE 2014



PISHOP

www.pishop.co.za



# WeatherMan



**Martin Mander**

Martin works in the Intelligence & Analytics Department at Norfolk County Council. He's passionate about giving old tech a new lease of life, especially projects involving Raspberry Pi.

[magpi.cc/oldtechprojects](http://magpi.cc/oldtechprojects)

A shiny music box with a clear door for a screen proves an ideal upcycling candidate for an eighties tech fan keen to keep tabs on the weather. **Rosie Hattersley** hears more

**M**artin Mander is no stranger to repurposing outdated tech. “I started converting and upcycling vintage technology about ten years ago, after a brief stint blogging for Wired’s GeekDad column,” he tells us. Discovering he enjoyed documenting projects as much as building them, he began specialising in giving new purpose to broken old tech – “especially items I remember being ‘the latest thing’ during the 1970s and 1980s when I was a child.”

Martin became enamoured of all things Raspberry Pi-flavoured in 2014. Looking for a one-box alternative to a PC for converted gadgets, he was tipped off by a reader that Raspberry Pi might work. He duly made a Raspberry Pi-powered VCR. Numerous ‘fruitful’ projects followed. There’s now a sizeable archive at [magpi.cc/oldtechprojects](http://magpi.cc/oldtechprojects).

The Walkman, of course, fits that description to a tee. Sony alone sold 200 million, while other brands of cassette player were also legion.

“I immediately fell in love with it... It had a great retro look”

### Press play

Martin’s chance to ‘rescue’ one came when his mother-in-law sent him a broken old Hitachi player that she found during a clear-out.

“I immediately fell in love with it,” Martin recalls. “It had a great retro look that drew me in”. On closer examination he realised the window in



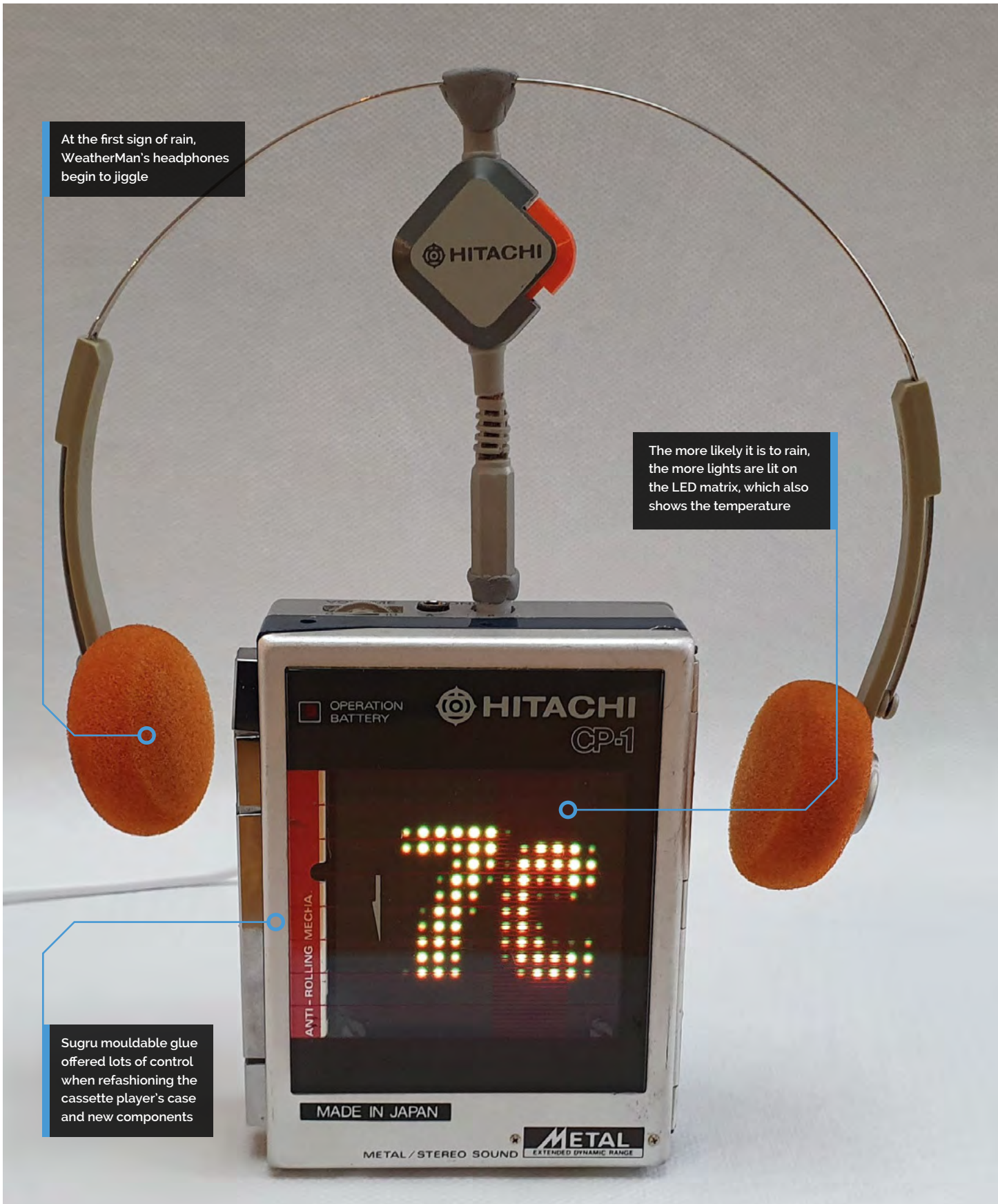

At the first sign of rain, WeatherMan's headphones begin to jiggle

The more likely it is to rain, the more lights are lit on the LED matrix, which also shows the temperature

Sugru mouldable glue offered lots of control when refashioning the cassette player's case and new components

Quick **FACTS**

- ▶ Martin's first tech encounter was with a BBC Micro at school
- ▶ He half expected singers to appear if music cassettes were used with it
- ▶ Martin's home has 25 Raspberry Pi devices for both security and entertainment duties
- ▶ He has a 'lovely but trashed' 1960s Dansette radio ripe for conversion...
- ▶ Key attraction: it perfectly matches the colour scheme in his bathroom

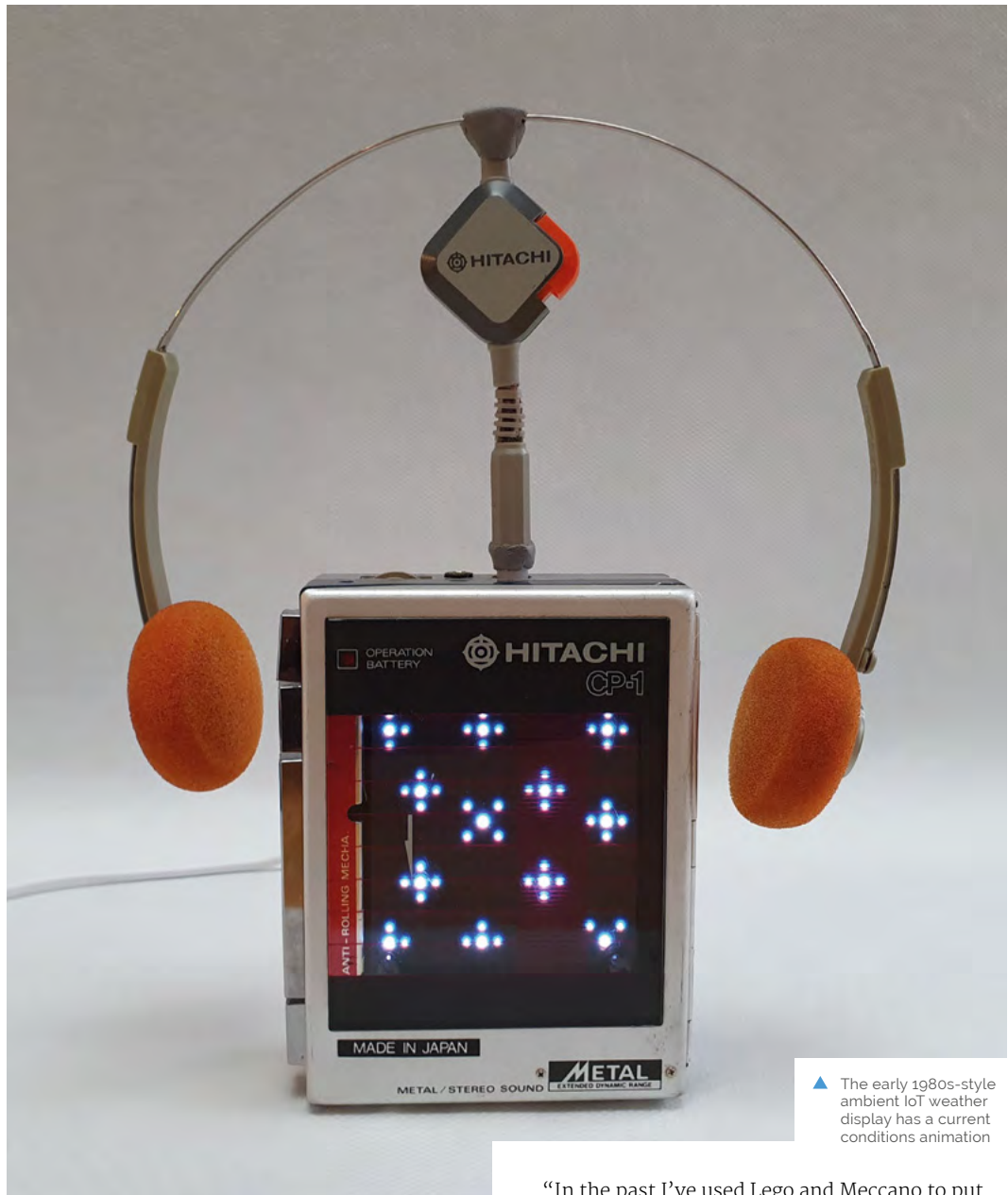

▲ The early 1980s-style ambient IoT weather display has a current conditions animation

“ I'd been looking for a small case to hold a weather display for my desk for a while ”

the cassette player's door was – to the millimetre – the same size as a Raspberry Pi HAT. “At that point, all my other projects hit the back burner,” he says.

“I'd been looking for a small case to hold a weather display for my desk for a while, and this was the perfect thing. I also had an unused Unicorn HAT HD lying around and this seemed like the ideal project for it.” To this he added servos and an awful lot of Sugru – a sort of malleable glue.

“In the past I've used Lego and Meccano to put things together, but with space being so tight in the case, I used Sugru this time around. It's very workable but sets hard like plastic, perfect for fixing components in the right place.”

The WeatherMan currently relies on API data from the Dark Sky weather service, but Martin eventually hopes to link it up to a Raspberry Pi weather station. “With a Raspberry Pi at each end, it should hopefully be straightforward!” he says optimistically.

**Getting the details right**

The main aim for what became the WeatherMan project was to keep the exterior as true as possible to the original. He wanted it to look like an



## WeatherMan Pi

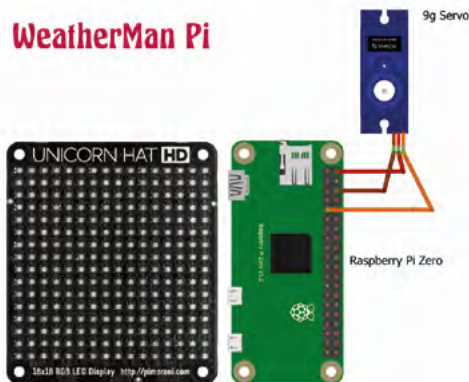

▲ Helpfully, a Raspberry Pi Unicorn HAT is precisely the same size as the cassette player's display window

▲ Diagram showing the relatively simple setup involved in creating the WeatherMan project

ornamental piece sitting on his desk speaker, hiding a useful IoT (Internet of Things) device until it bursts into life.

Martin thought the tape player seemed a bit naked without the iconic eighties headphones, so he looked for ways to incorporate them into the build. He drilled out the original jack plug and fittings and joined them together using a 2 mm threaded rod. With a small nut on each end of the rod and a servo connector at the bottom, the headphones now respond whenever the weather is about to change. Their servo-controlled jiggling always makes Martin smile, even if it's to alert him rain is on the way. [M](#)

## Make your own WeatherMan



**01** Dismantle the cassette player to create as much space as you can inside. Retain any parts you want to reuse. You may need to trim down the case inside to make the components fit nicely.

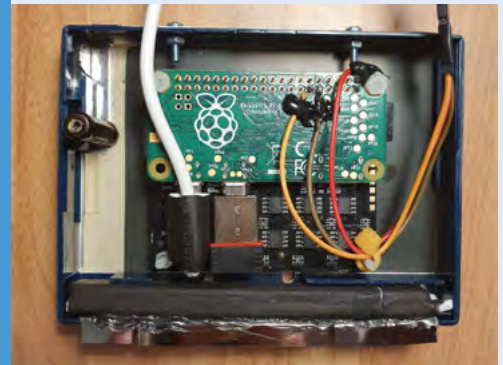

**02** You may need new bolts or a tiny magnet to make the cassette tape door close properly once you've tinkered inside. When you're satisfied that it works well, hot-glue the cassette player case and door.

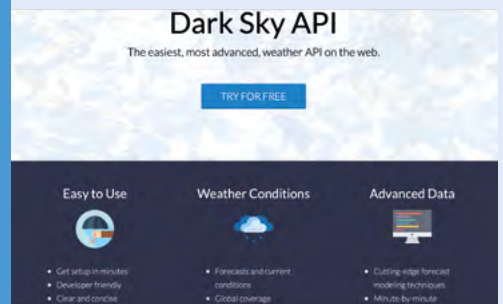

**03** Use Raspbian Buster and adapted Python scripts to retrieve weather data from Dark Sky, display info on the Unicorn HAT, and (optionally) jiggle the headphones. Scripts and a ReadMe are on GitHub at [magpi.cc/ghweatherman](https://magpi.cc/ghweatherman).

# Pi Commander

Adrien Castel's idea of converting an old electronic toy into a retro games machine was no flight of fancy, as **David Crookes** discovers



**Adrien Castel**

Adrien is an IT technician and graphic designer specialising in 3D and VFX. He lives in France and loves building stuff that involves electronics.

[magpi.cc/picommander](http://magpi.cc/picommander)

**T**he 1980s was a golden era for imaginative electronic toys. Children would pester their parents for a Tomytronic 3D or a Nintendo Game & Watch. And they would enviously eye anyone who had a Tomy Turnin' Turbo Dashboard with its promise of replicating the thrill of driving (albeit without the traffic jams).

Two years ago, maker Matt Brailsford turned that amazing toy into a fully working Out Run arcade machine and Adrien Castel was smitten. "I loved the fact that he'd upcycled an old toy and created something that could be enjoyed as a grown-up," he says. "But I wanted to push the simulation a bit further and I thought a flying sim could do the trick."

Ideas began flying around Adrien's mind. "I knew what I wanted to achieve so I made an overall plan in my head," he recalls. First he found the perfect toy: a battery-powered Sky Fighter F-16 tabletop game made by Dival. He then decided to

base his build around a Raspberry Pi 3A+. "It's the perfect hardware for projects like this because of its flexibility," Adrien says.

## Taking off

The toy needed some work. Its original bright red joystick was missing and Adrien knew he'd have to replace the original screen with a TFT LCD. To do this, he 3D-printed a frame to fit the TFT display and he created a smaller base for the replacement joystick. Adrien also changed the microswitches for greater sensitivity but he didn't go overboard with the changes.

"I knew I would have to adapt some parts for the joystick and for the screen, but I didn't want to modify the look of the toy," Adrien explains. "To be honest, modifying the toy would have involved some sanding and painting and I was worried that it would ruin the overall effect of the project if it was badly executed."

As such, a challenge was set. "I had to keep most of the original parts such as throttle levers and LEDs and adapt them to the new build," he says. "This meant getting them to work together with the system and it also meant using the original PCB, getting rid of the components and re-routing the electronics to plug on the GPIOs."

▶ The games can make use of the full screen. Adrien would have liked a larger screen, but the original ratio oddly lay between 4:3 and 16:9, making a bigger display harder to find

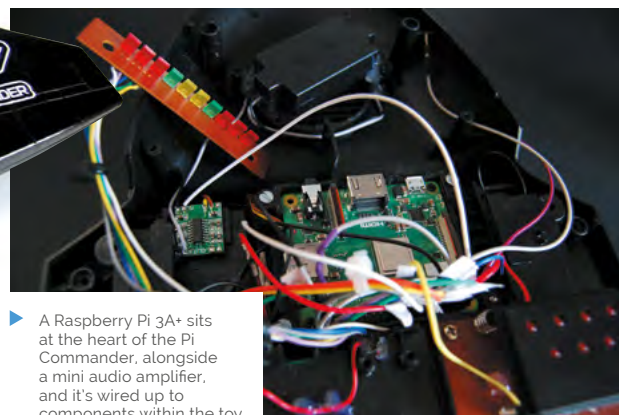

▶ A Raspberry Pi 3A+ sits at the heart of the Pi Commander, alongside a mini audio amplifier, and it's wired up to components within the toy



All of the buttons, other than the joystick, are original to the toy – as are the seven red LED lights

Games can display in a small window within Adrien's custom front end, with the list of games displayed beneath

### Quick FACTS

- ▶ Dival's Sky Fighter F-16 toy is repurposed
- ▶ Its internal components were desoldered
- ▶ A four-inch 800×480 HDMI TFT screen is used
- ▶ Adrien suggests trying an analogue joystick
- ▶ Games are chosen using a Select key

Adrien was inspired by a real F-16 cockpit and created a set of cool custom stickers

There were some enhancements. Adrien soldered a PAM8403 3W class-D audio amplifier to Raspberry Pi and this allowed a basic speaker to replace the original for better sound. But there were some compromises too.

“At first I thought the screen could be bigger than the one I used, but the round shape of the cockpit didn't give much space to fit a screen larger than four inches.” He also believes the project could be improved with a better joystick: “The one I've used is a simple two-button arcade stick with a jet fighter look.”

### Flying high

By using the retro gaming OS Recalbox (based on EmulationStation and RetroArch), however, he's been able to perfect the overall feel. “Recalbox allowed me to create a custom front end that matches the look of a jet fighter,” he explains. It also means the Pi Commander plays shoot-'em-up games alongside open-source simulators like FlightGear ([flightgear.org](http://flightgear.org)). “It's a lot of fun.”

“ I didn't want to modify the look of the toy ”

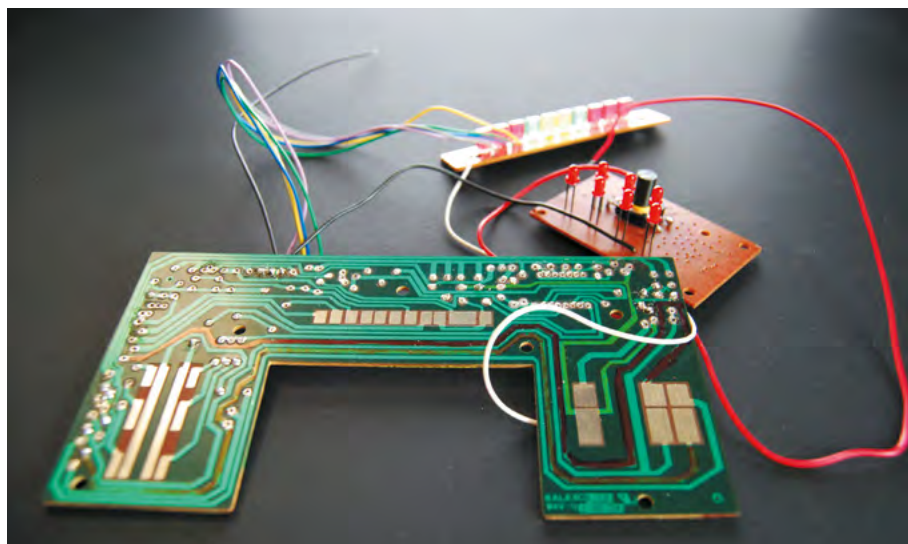

▲ The original PCB was used and the electronics were re-routed. All the components need to work between 3.3 to 5V with the lowest possible amperage while fitting into a tight space

# Oktoberfest Pinball Machine

Real-life arcade halls may be off-limits, but by the power of Raspberry Pi you can play real pinball online. **Rosie Hattersley** flips out



**Stan Dmitriev**

MAKER

Stan works at real-life online games company Surrogate.tv in Espoo, Finland. Their marvellously geeky office is strewn with more than 100 Raspberry Pi 4 computers.

[surrogate.tv](http://surrogate.tv)

**M**any of us dream of having our own games room, quite possibly with a pinball machine at its centre. Such fantasy comes with a rather large price tag, so the idea of being able to play a proper pinball machine, albeit via the internet, holds a strong appeal. This was the thinking behind Finnish company Surrogate.tv, which specialises in creating real-life games experiences that can be played online. The two-year-old company has recently launched its first Raspberry Pi-based pinball game, the Oktoberfest Pinball Machine, in which players shoot balls to gradually fill a stein of beer while an oompah band sings a toast.

While the theme may seem timely since the legendary Munich beer festival ought to be taking place in September, Surrogate.tv's Stan Dmitriev tells us that it just so happened this design of vintage pinball machine came up for sale while they were pondering a Raspberry Pi 4-based design. The 20-strong staff of Surrogate.tv are "a bunch of gamers and geeks," says Stan. He estimates that there are more than 100 Raspberry Pi 4 computers in the office! Some have been used to control various robots – one of their other offerings is a SumoBot challenge in which real sumo robots battle it out in an arena, controlled

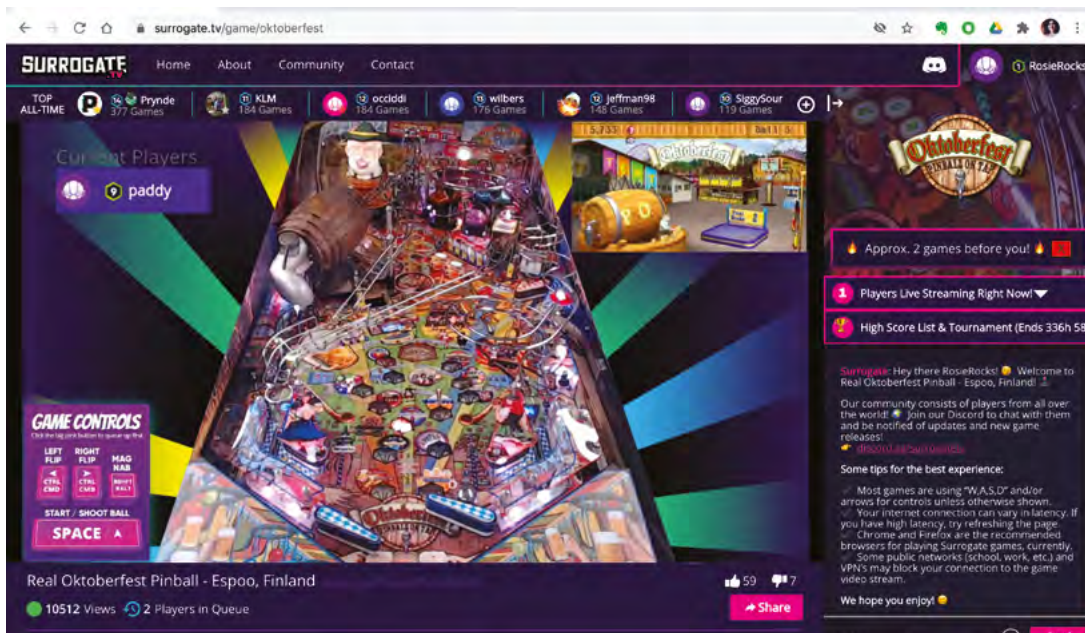

▶ Play the real Oktoberfest Pinball Machine for free in Chrome or Firefox

# SURROGATE TV

BUBBLE B\*88LE P\*600

```

Surrogate TV
-----
Player 1: 1000
Player 2: 1000
Game: 1000
Score: 1000
Level: 1
Time: 00:00

```

A Logitech webcam trained on the pinball machine instantly relays the action to the online player

Switches on the specially designed Surrogate Raspberry Pi HAT start a game and activate the pinball plunger and flippers

The controls of an original pinball machine have been reconfigured so it can be played over the internet

### Quick FACTS

- ▶ The oompah-accompanied Oktoberfest Pinball Machine runs 24/7
- ▶ Thankfully, it lives in a sound-insulating cabinet
- ▶ On May The 4th Day, Surrogate.tv launched a Star Wars special.
- ▶ ..Raspberry Pi-powered The Force Claw
- ▶ Some multi-Raspberry Pi 4 projects are in the pipeline

▶ Getting Raspberry Pi to recognise the start and end of a game centred on how the Start button's LED behaved

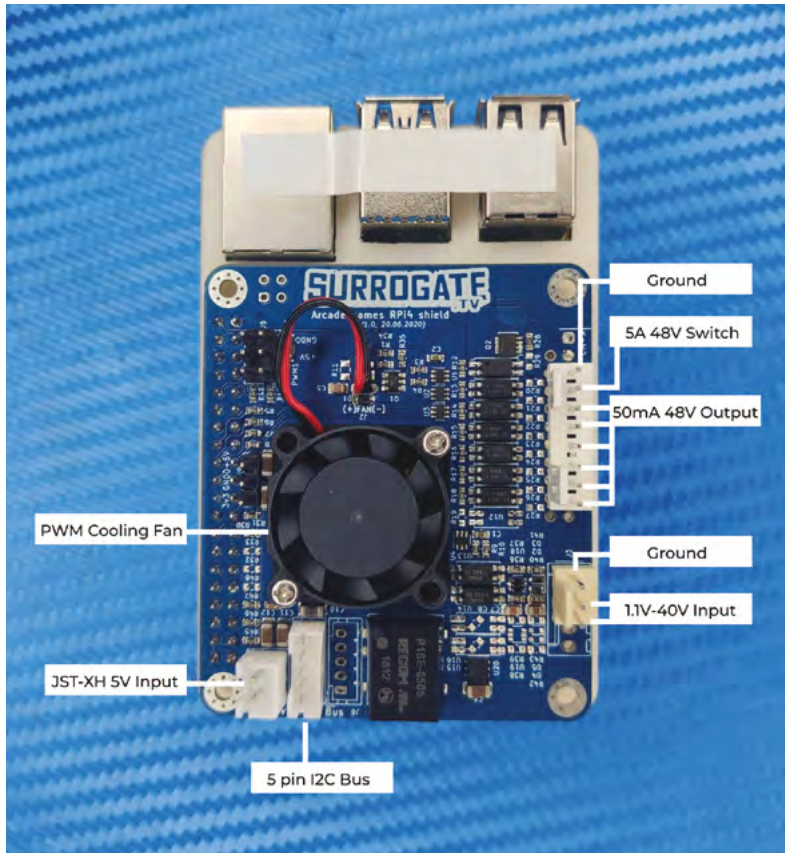

▶ Surrogate.tv designed a Raspberry Pi 4 arcade game HAT for use with different types of arcade machine



**Alert!  
High voltage**

Be careful when working with mains electricity.

[magpi.cc/electricalsafety](http://magpi.cc/electricalsafety)

by players over the internet. However, they'd also have a powerful computer on the side to execute the ultra-low-latency video streaming part of the project stack.

### Flipping fun

The Oktoberfest Pinball Machine is the first project they've created in which Raspberry Pi handles the whole setup. "Players can control the flippers using the left and right **CTRL/CMD** key and can shoot the ball from the plunger using the **SPACE** bar on the keyboard," explains Stan. Webcams provide a live feed of the pinball bouncing around inside the machine, with the human player responding by hitting the flipper buttons to keep it moving and away from the danger zone. One webcam shows the action, while another shows the current and high scores. "Both



these video feeds and the audio feed are combined using Raspberry Pi's compute capabilities, encoded into a single compressed video feed and sent to the user in near real-time using the SurroRTG suite," he says.

Like in a real arcade hall, you have to queue to play, since you really are playing the actual machine. Blinking LEDs on the machine at the end of a game are recognised by Raspberry Pi, which then invites the next person to play. They undertook lots of analysis before realising the Start button LED operates in a very specific way based on the pinball machine's state, says Stan. "By reading this behaviour and inputting it to Raspberry Pi, we managed to solve the challenge."

### Pinball wizardry

Their existing online pinball machine, Batman '66, proved very popular, and players were asking for more machines. For the Oktoberfest machine, they took a more streamlined approach than the Batman machine, with plans to simplify the process of hooking up pinball machines for online play. "We wanted to make the setup replicable," reveals Stan.





To this end, they designed their own arcade machine HAT with eight output switches. This Raspberry Pi 4 HAT works with a range of arcade machines, including claw ones. It has its own cooling fan, as well as dedicated switches corresponding to arcade machine controls

“ Like in a real arcade hall, you have to queue to play, since you really are playing the actual machine ”

and audio and video feeds. The Oktoberfest machine also uses Surrogate’s own SurroRTG low-latency video codec to enable a smooth gaming experience.

Most of the code to interact with the arcade machine and for the game logic is Python-based. Although the SurroRTG software is not currently available on GitHub, Surrogate.tv are set to launch it as a free download in the coming weeks and reassure us there are exciting plans afoot to entice makers with an eye on creating their own gaming setup. [🔗](#)

## Single-player mode



- 01** To turn an arcade machine into one playable online, download the SurroRTG software (it will be a free download launching this autumn), install it on Raspberry Pi 4, and navigate to [surrogate.tv](https://surrogate.tv).

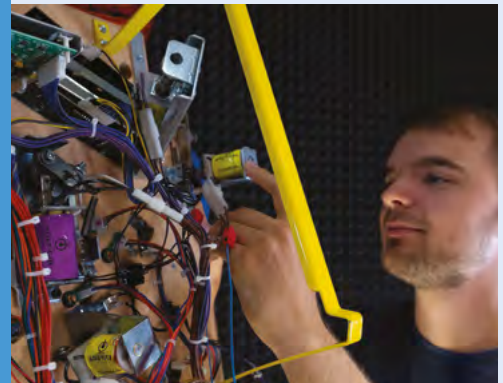

- 02** Hook up the wires for the flipper and control buttons on your arcade machine to corresponding pins on your Raspberry Pi, then wire up the Start button LED and the ball lane detector sensor.



- 03** Position webcams so the pinball machine screen can be seen, then attach them via USB to Raspberry Pi 4. Either connect the machine’s audio to a USB audio card or use the webcam microphone. Plug in an Ethernet cable and power source.



A typical night in Joe's driveway in Alabama. He's lucky to live somewhere with little light pollution

The project's Raspberry Pi is at the base of the rig, and has a touchscreen

The tracking scope is mounted to the top of the primary telescope. There are two cameras: a CCD on the tracking scope and a DSLR on the primary scope



Joe Kutner

MAKER

Joe Kutner (aka Codefinger) is a software architect at [Salesforce.com](https://www.salesforce.com), where he works primarily with Java and other open-source technologies. He's published several books about programming with Ruby and Java. He enjoys amateur astronomy, mostly observationally, but he also dabbles in astrophotography.

[@codefinger](https://twitter.com/codefinger)

# Astrophotography Autoguider

The awe-inspiring wonders of the night sky encouraged a keen stargazer to find a better way to capture their beauty. **Rosie Hattersley** gets inspired

**C**reating stunning photographs of the night sky requires planning, patience, and reliable star-tracking equipment. A desire to travel a little lighter led keen amateur astronomer Joe Kutner to embark on his first Raspberry Pi project.

Joe says there's nothing worse than taking hours of astrophotography images only to find out your telescope was drifting, causing the stars to look more like lines than points. To protect against this kind of misalignment, he needed an autoguider: a computer and camera that track a star in the telescope's field of view to ensure that it stays in the same position throughout the session.

"The main goal of my project was to get rid of the laptop," Joe tells us. "I needed to control my telescope in the field. I spend enough time in front of a computer at work, and the laptop took the fun

out of observing. It served an important function, though: controlling both my camera and my mount. Without it I would only be able to take very short exposures of the moon and planets."

Joe considered using an iPad or a Microsoft Surface instead, but both were far too expensive. He wanted to keep the build cost below \$100, and neither worked well with his chosen software.

Instead Joe picked up a Raspberry Pi, a case, and a touchscreen for less than \$100, and added a red plastic cover so he was still able to use the setup in night-vision mode. These work alongside the various bits of astronomy kit Joe uses regularly on his stargazing missions.

## Under open skies

Joe made extensive use of general purpose open-source software such as Raspbian Stretch and Git,

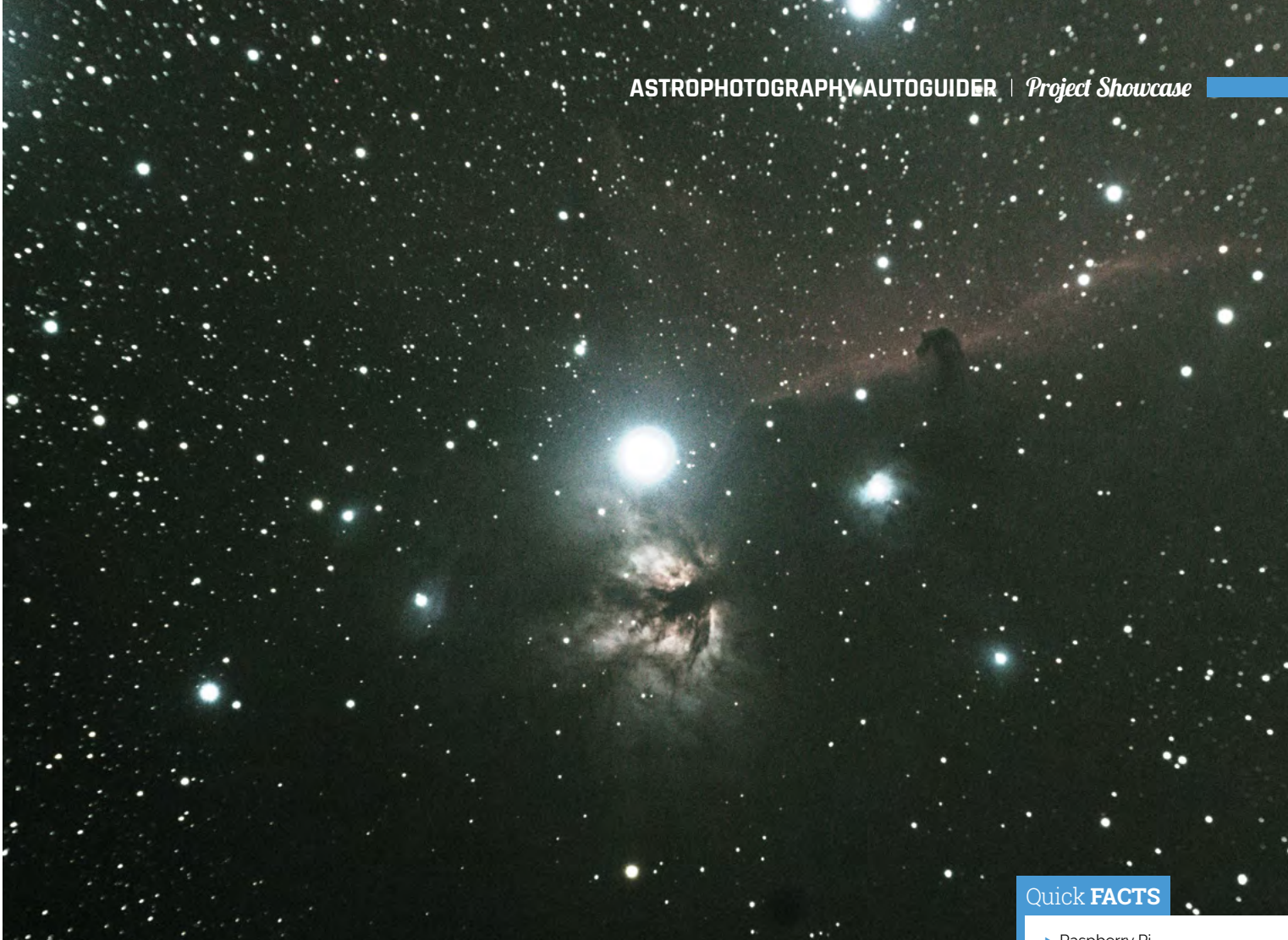

▲ The Horsehead Nebula and Flame Nebula, photographed from Joe's Alabama driveway with the help of his Raspberry Pi-controlled autoguider

### Quick FACTS

- ▶ Raspberry Pi records over several hours while Joe sleeps in his tent
- ▶ Joe recommends Lacerta MGEN II ([magpi.cc/3XGdSW](http://magpi.cc/3XGdSW)) if you don't want to build your own
- ▶ Many of his astronomy photos are taken from Huntsville, Alabama
- ▶ He's using Raspberry Pi to attempt to image an exoplanet transit
- ▶ He also blogs about coders' fitness and nutrition at [healthyprog.com](http://healthyprog.com)



▼ Raspberry Pi in a case with a red plastic overlay so it can be used at night



▲ Lagoon Nebula (Messier 8), a giant interstellar cloud located in the constellation of Sagittarius

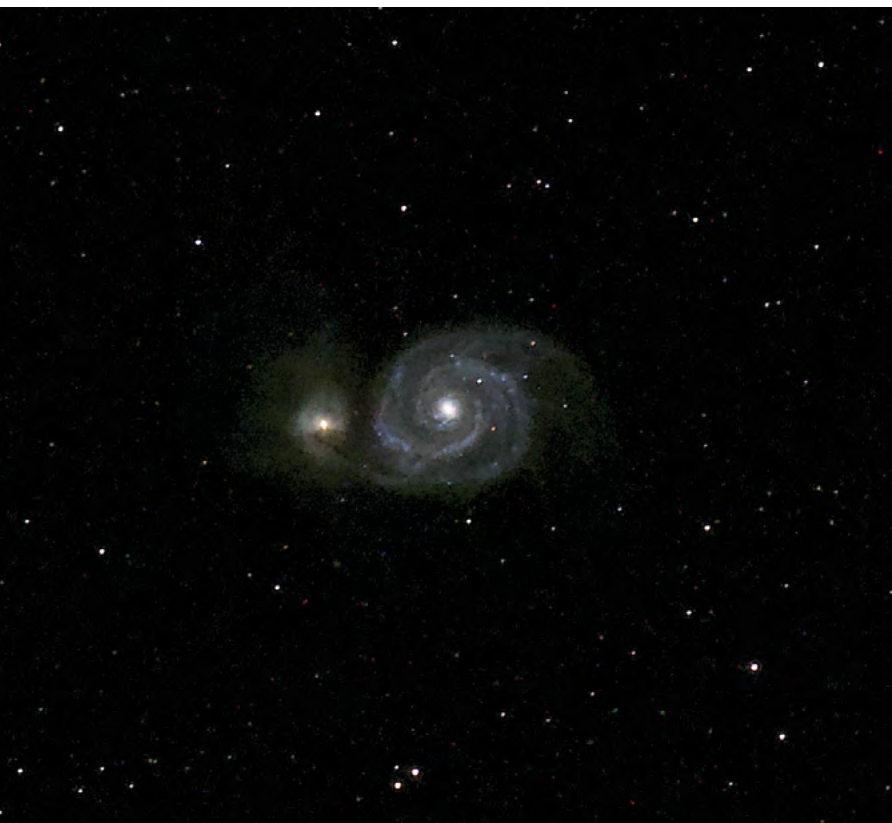

▲ Whirlpool Galaxy (Messier 51) taken at the Texas Star Party 2019 in Fort Davis

plus astronomy-specific open-source tools Libnova ([magpi.cc/libnova](http://magpi.cc/libnova)), INDI ([indilib.org](http://indilib.org)), and PHD2 ([openphdguiding.org](http://openphdguiding.org)) telescope guiding software.

He wrote scripts to automate the software so he could just use the touchscreen, without a mouse or keyboard. But for the most part, things worked without customisation.

“ I can roll it onto my driveway and start imaging in just a few minutes ”

“Every step in the process had its challenges,” Joe recalls. “I would install one piece of software and then find out it wasn’t compatible with some version of another piece of software I needed. When I finally got everything running, it wouldn’t talk to my telescope until I installed yet another version of the software. There were dozens of these little paper-cuts, but in the end it was worth working through them.”

Joe also says the hardware he chose worked perfectly from day one. Any tweaks he made were “mostly minor issues like figuring out how to install the correct version of a particular camera driver”.

His Raspberry Pi now has an on-board autoguiding system for his astrophotography rig.



Because Raspberry Pi attaches to the base of the mount, it's easily accessible. Unlike using a laptop, there's no need for an extra table or complicated wiring. Joe says the setup is perfect for his needs: "I can roll my telescope onto my driveway and start imaging in just a few minutes."

▲ The lightweight nature of Joe's astrophotography setup makes it easy to move around

### International expansion

Now that Joe has successfully built a fairly portable astrophotography rig, he sees its potential for explorations further afield. He's keen to try out his autoguider with other types of astrophotography kit such as the ultra-compact Sky-Watcher Star Adventurer series of mounts. "When combined with my Raspberry Pi," he says, "I could take the whole rig on an airplane as carry-on. That would give me access to some very dark skies." [M](#)

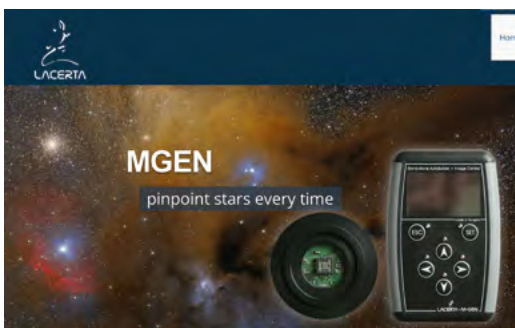

▲ Lacerta MGEN II is a good alternative if you don't want to build your own autoguider

## Build an autoguider



**01** Start with a fresh installation of Raspbian and download the package for libnova 0.14. You can find the install instructions at Joe's GitHub page ([magpi.cc/Xn4JCE](https://magpi.cc/Xn4JCE)).



**02** Use the GitHub instructions to build INDI, the software to connect Raspberry Pi to your digital camera and mount. Install the Atik camera driver if needed.



**03** Install and build PHD2 autoguiding software, then start the INDI server so it looks for the camera and mount. Save the profile for future reference.

# Hot Spotter

An autonomous drone that can detect and report smouldering fires. **Phil King** seeks it out



**Jason McDonald**

Jason has a degree in Applied Physics and numerous 'nanodegrees' for machine learning and AI. He is currently enrolled at the University of Montana in the welding technology program.

[magpi.cc/hotspotter](http://magpi.cc/hotspotter)



## Alert!

Drone use is regulated in some territories (including the UK and USA).

[magpi.cc/CAAdrones](http://magpi.cc/CAAdrones)  
[magpi.cc/FAAdrones](http://magpi.cc/FAAdrones)

▶ Preparing for take-off, the Hot Spotter drone is pictured in front of a charcoal fire used for testing purposes

**W**hile commercial operations use fleets of expensive drones to track the spread of wildfires, it's possible for a previously extinguished fire to relight. It's in the detection of these smouldering patches where a low-cost drone such as Jason McDonald's Hot Spotter could come in useful.

"I wanted to create something practical with the [NXP HoverGames drone] kit that filled a niche not already being targeted by the commercial drone industry and/or lower the cost of a current application," he reveals.

Made from off-the-shelf hardware, including a Raspberry Pi 3A+, the Hot Spotter can survey an area to create a heat map. "As the drone flies over an area, it records average temperatures of spots on the ground," explains Jason. "The size of the spot depends on how high the drone is flying, in the same way the spot size from a flashlight depends on how far away it is from a surface."

The software creates an imaginary grid of points, spaced about one metre apart, to be used for the heat map. When the drone takes a temperature reading of a spot, it's recorded for all the points contained within it. Then, when the heat map is generated, all the readings for a given point are averaged together. "This method helps to localise heat sources and distinguish between large warm regions versus hot spots."

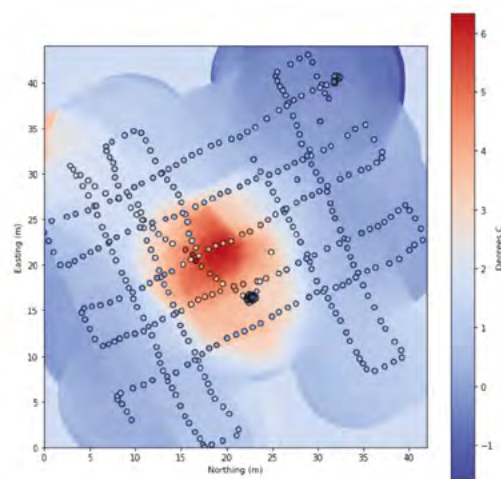

▶ An example heat map generated by the drone's Raspberry Pi as it flew a cross-hatch pattern above the survey area

As the drone flies a cross-hatch pattern to survey the area, its on-board GPS is used to determine its precise position while a lidar module measures the distance to the ground. This results in more accurate heat mapping than when estimating the height, as well as opening up the possibility of terrain following and obstacle avoidance.

## Altitude testing

"For my tests, the drone flew about 20 metres above the ground," says Jason. "I would like to test at other altitudes. Since the size of the spot being measured increases with altitude, the drone can cover more area from higher altitudes at the expense of heat map fidelity. Ideally I would like to create a quick map from a high altitude followed by a higher fidelity map at a lower altitude for regions that look like potential hot spots."

The on-board Raspberry Pi 3A+ communicates with the drone's flight controller (using the MAVLink protocol) to receive information such as its GPS position and orientation. "Raspberry Pi handles all of the calculations necessary to generate a heat map from sensor data recorded by the drone and from sensors attached directly to the GPIO using an I<sup>2</sup>C hub," says Jason. "Raspberry Pi can also command any autonomous

Connected to a Raspberry Pi 3A+, the thermal sensor on the drone's underside detects the ground temperature

A lidar sensor is used to measure the distance to the ground below for increased accuracy of the heat map

LiPo battery power is wired via the drone's power distribution board and a UBEC

#### Quick FACTS

- ▶ The project won a special award in a HoverGames contest
- ▶ It's powered by a 5200mAh LiPo battery
- ▶ The drone can hover for a solid 20 minutes
- ▶ In a ten-minute flight, it can survey a 1600m<sup>2</sup> area twice
- ▶ The code is on GitHub: [magpi.cc/hotspottergit](https://github.com/magpi.cc/hotspottergit)

functions such as setting a waypoint and returning to its launch point.”

It sends the data in real-time – using a wireless serial connection via a 500 mW transmitter – to a ground station laptop via another Raspberry Pi used as a wireless hotspot for a laptop.

### Crash landing

It took Jason three months to build and program the Hot Spotter. However, after numerous successful test flights, disaster struck when the drone crash-landed due to a malfunctioning rotor. “It was a bummer to say the least,” he says. “I have rebuilt the drone. Better than it was before. Better... stronger... faster.”

“ As the drone flies over an area, it records average temperatures of spots on the ground ”

While he thinks the drone’s practicality is solid from a cost standpoint, its practicality ‘in the wild’ remains to be seen. “I would like to do further testing that includes real-world scenarios. There is a fire science laboratory ([firelab.org](https://firelab.org)) near me and if they find it useful, the project might have a future there.” [M](#)

# Aquatic Mini Observation System

What computer do you use when you want to have a solar-powered, autonomous boat that measures water quality? **Rob Zwetsloot** discovers that the answer is Raspberry Pi



**MAKER**  
**Murray Lowery-Simpson**

Although coming from an engineering background, Murray has been developing software for a little over 20 years.

[innaturerobotics.com](http://innaturerobotics.com)

▶ AMOS will be useful to researchers, and a good base for hobbyists

**T**here are many basic rules when it comes to electronics. One of them is that water and electronics don't mix, even if your average smartphone is able to take a brief dunk in the sink these days. So when someone comes to us talking about a waterborne project, we listen – and that's exactly what happened when Murray Lowery-Simpson emailed us about his solar-powered boat.

"My project is named AMOS (Aquatic Mini Observation System)," Murray tells us. "It is a solar-powered, autonomous airboat for measuring water quality over large, distributed areas."

Murray has worked on a couple of prototypes for the boat. The first one was made out of a kayak beer cooler (a small kayak that acts as a beer cooler) and had propellers that would end up getting gunked up. He also tested distance measuring with a Raspberry Pi Compute Module's stereo vision before settling on a lidar module and a Raspberry Pi 3B+.

"During this past winter, I built a second prototype, this time using a longer surfboard-type design constructed from glued-together insulation foam that was given a coat of fiberglass to give it some added strength and stiffness," Murray explains. "Instead of the water propellers, a single 10-inch drone propeller and motor were used and connected to a small waterproof servo motor at the stern end of the boat. This design was lighter (about 13 kg) and longer, and although the air propeller only produced about a tenth of the thrust provided by the dual water propellers, the improved draft and hydrodynamic shape made it slightly faster in the water."

A Raspberry Pi controls the speed and angle of the air propeller, takes sensor readings from the water, interacts with the lidar module, and has several other functions so that it knows its speed and heading.





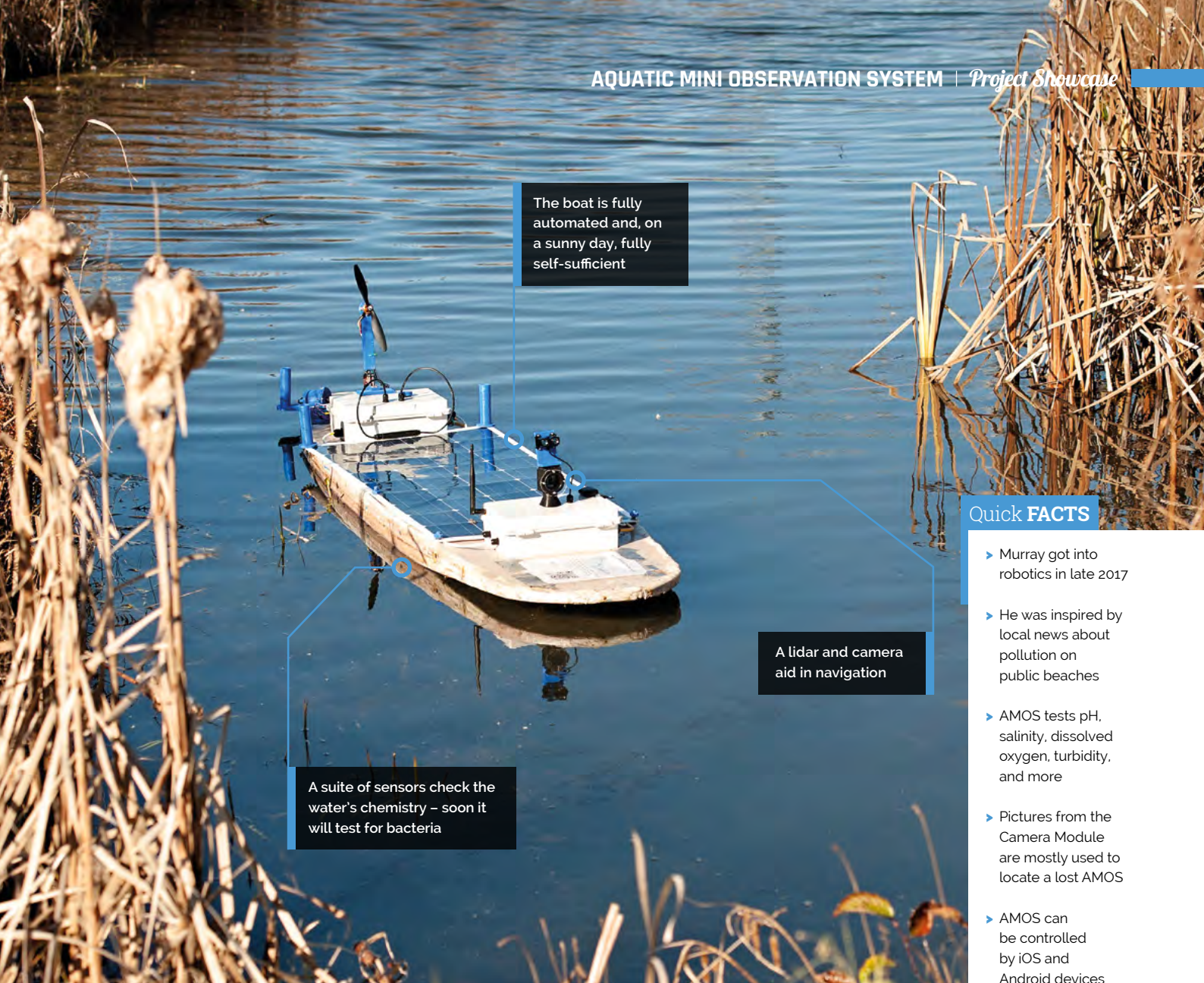

The boat is fully automated and, on a sunny day, fully self-sufficient

A lidar and camera aid in navigation

A suite of sensors check the water's chemistry – soon it will test for bacteria

### Quick FACTS

- ▶ Murray got into robotics in late 2017
- ▶ He was inspired by local news about pollution on public beaches
- ▶ AMOS tests pH, salinity, dissolved oxygen, turbidity, and more
- ▶ Pictures from the Camera Module are mostly used to locate a lost AMOS
- ▶ AMOS can be controlled by iOS and Android devices



◀ The old version was a bit slower and stubbier, and the fans would get weeds stuck in them



▲ This photo gives you an idea of the size of the boat

“I’m hoping that AMOS will be used for water testing by environmental services companies, and industrial customers such as mine operators that may be required by law to confirm that pollution limits in bodies of water surrounding their operations are not exceeded,” Murray reveals. “I’m hoping also to be able to offer it at an attractive

“ Approximately 150 km of testing has been completed on the second AMOS prototype ”

price point, with modular components so that researchers or robotic boat enthusiasts could also use it, or some subset of it, in their own projects.”

### Major tests

The prototypes aren’t just proofs of concept, either: they’re fully functioning test beds, as Murray explains: “Approximately 150 km of testing has been completed on the second AMOS prototype in 2019. It can work well in shallow water (as little as 2 cm depth) and can travel through regions of water with lots of grass or other vegetation without any worries about getting stuck. Its airboat design works best under conditions of low wind (less than 20 km/h) and it can travel at a top speed of about 2.7 knots (5 km/h). Provided the sun is shining on a clear day and higher than about 40 degrees in the sky, AMOS can run at top speed without depleting the charge of its battery.”

Murray plans for AMOS to be on sale in the summer, so you don’t have too long to wait. [M](#)



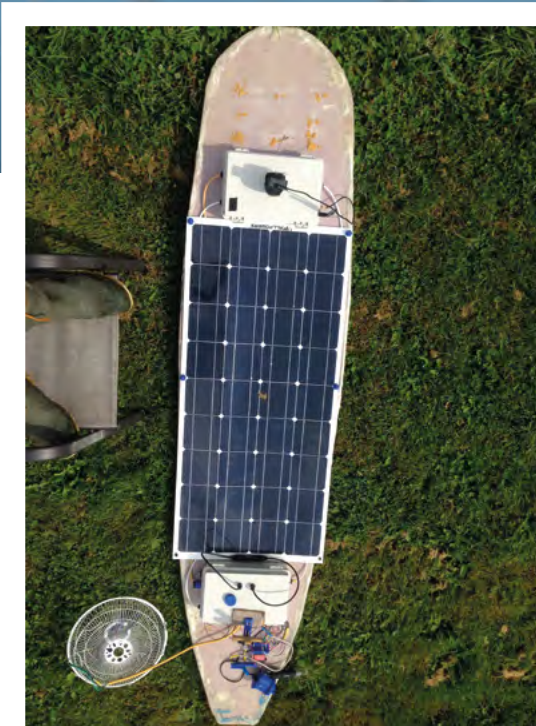

- ▲ We think the AMOS looks quite majestic as it pootles about
- AMOS also works in cold weather, although a lack of sun means it can't operate for long
- ◀ The surfboard body makes it light, and its length allows for a large solar panel

## Testing the waters



**01** A boat needs to be launched. You can control the destination using a smartphone; there are apps for Android and iOS that you can find on the GitHub page: [magpi.cc/amosGH](https://magpi.cc/amosGH).



**02** Using a combination of GPS, lidar, and cameras, the boat navigates its way around waterways and rivers. This allows it to obtain a big sample from any given area, and see how it changes throughout.



**03** On a sunny day, it can happily take readings all day without too much interference. On a cloudy day, it may only operate for up to an hour. Although a bigger battery might solve this, it will be heavier.

# Airdrum

This drum set can be played with a hover of your hands and gives visual feedback too, as **David Crookes** learns



**MAKER**  
Alessandro Verdiesen and Luuk van Kuijk

Alessandro is an electronics engineer with a passion for drones and speaker systems, while Luuk is studying for his master's degree in next level engineering.

[magpi.cc/airdrum](http://magpi.cc/airdrum)

**W**e're always going to beat the drum for projects that seek to improve the lives of people with severe disabilities. To that end, we fell in love with the Airdrum, which was created to allow anyone – in particular those with a mental or physical condition – to play a traditional instrument.

Designed by two Dutch electrical engineering students, Alessandro Verdiesen and Luuk van Kuijk, the project came to life during their first year at university. “We aimed to develop a musical instrument that could be used to generate music by moving,” explains Alessandro, who has recently been working on a fully modular version 2.0.

After speaking with therapists and health care institutions, the pair decided to make a drum that could be played by moving objects above a set of panels and they put a Raspberry Pi at its heart. “The basic functionality of the Airdrum is to detect the distance of an object above each connected panel and play a sound,” says Alessandro. “These panels contain IR distance sensors and coloured LEDs for visual feedback.”

## Sorting the bass-ics

From the outset, Alessandro and Luuk needed their project to be accessible, affordable, adjustable and, in the latest iteration, modular, with each drumable section containing an Arduino Mini, an IR sensor, and LEDs. They also wanted the



▶ A lot of meticulous planning has gone into the creation of the Airdrum over the past few years



▶ Custom-made Airdrum detecting modules fit snugly into their 3D-printed cases and can be arranged in a full circle if you have enough of them

instrument to have a broader appeal and be suitable for everybody, including professional musicians, so it had to sound as good as it played.

“We needed it to be as versatile as it can be and allow people to choose custom sounds, colours, and lights while being a standalone instrument and a multi-purpose input/output device,” Alessandro reveals. To make it easy to place the modules together, they used magnetic connections between the panels. This allowed them to be placed together in various configurations, with a minimum of two per Airdrum.

With a structured plan that divided milestones into electrical, mechanical, and software components, the pair used 3D printing for the enclosure, which enabled rapid prototyping for quick interactions. They used speaker panels to bookend the modules for auditive feedback.

## Panel beating

Each of the panels includes a buck converter so that the current through the connectors can be drawn to a minimum. The master module panel contains a Raspberry Pi 3 running custom-made programs written in C and Python, as well

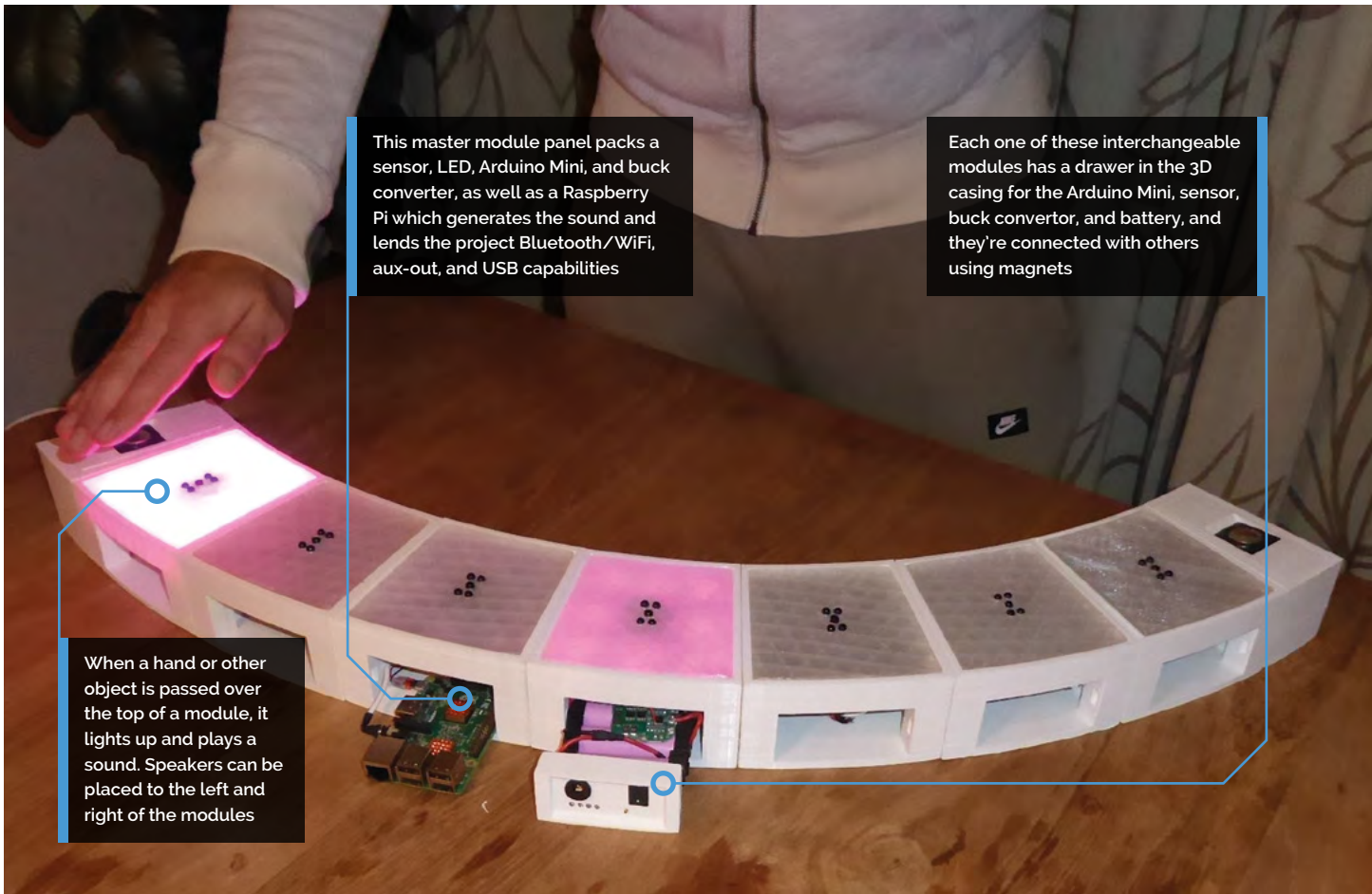

This master module panel packs a sensor, LED, Arduino Mini, and buck converter, as well as a Raspberry Pi which generates the sound and lends the project Bluetooth/WiFi, aux-out, and USB capabilities

Each one of these interchangeable modules has a drawer in the 3D casing for the Arduino Mini, sensor, buck converter, and battery, and they're connected with others using magnets

When a hand or other object is passed over the top of a module, it lights up and plays a sound. Speakers can be placed to the left and right of the modules

“ It also has a I2C bus to act as a data transfer master unit ”

as the free open-source software synthesiser FluidSynth. It connects to the other panels through I2C, constantly polling the panels for their measurements and for the configuration of their colour.

“If an object has been detected, the Raspberry Pi generates a sound and outputs it on the AUX audio jack,” says Alessandro. “This output is then used by the mono D-class amplifiers in the speaker panels to make the tones audible.”

The pair chose a Raspberry Pi because of its versatility and technical prowess. “The AirDrum needed something powerful enough to run software to generate audio through MIDI using the input from the panels and the Raspberry Pi is a great universal and low-cost development board with integrated DAC for audio,” explains Alessandro. “It also has a I2C bus to act as a data transfer master unit and they’re compact enough

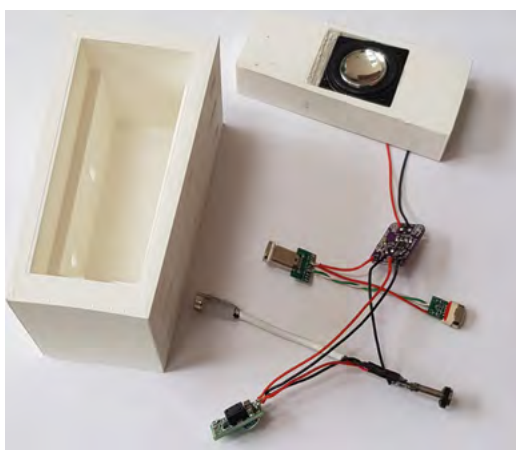

These speaker modules can bookend the sensor panels, although the sound can be outputted via the Raspberry Pi to a different sound system too

to fit inside of the casing. The Raspberry Pi enables easy implementation of future upgrades, too.”

Indeed, the pair want to explore the MIDI possibilities and connect the AirDrum with a smartphone or tablet. An app is being planned, as is a built-in synthesiser. “The people we have shown the AirDrum to have been very enthusiastic,” Alessandro says. “That has been very motivating.”

**Quick FACTS**

- ▶ Disabled people can play without holding it
- ▶ A new modular design makes it versatile
- ▶ It can play MIDI files via a Raspberry Pi
- ▶ The designers also want pro musicians to enjoy it
- ▶ A basic two-module AirDrum would cost about £120

# Cheeseborg

In wintertime, what could be more comforting than a grilled cheese sandwich? Cheeseborg uses Raspberry Pi to serve them up, as **Rosie Hattersley** smacks her lips



**Taylor Tabb**

MAKER

Taylor studied mechanical engineering at Carnegie Mellon University, exploring how people interact with hardware, and thinks Raspberry Pi is the ideal platform for this. He now works for creative agency DeepLocal, making 'wild and whimsical' robots.

[tabb.me](http://tabb.me)

**M**aking a splash with your final-year university project can be the ideal way to gain the attention of potential employers and land yourself your dream job. Appealing to your lecturers' and classmates' stomachs is also a pretty effective way of getting them inside. Hearing from Taylor Tabb about the robot project he and friends Mitchell Riek and Evan Hill cooked up for their mechanical engineering degree, it's little surprise to learn that having graduated in the summer of 2019, he's already embarked on a fantastic-sounding Raspberry Pi-focused career.

"Cheeseborg was born out of our need to concept, design, and build a final prototype of a project in our senior engineering design class," says Taylor. "As hungry college students awake at hours that it's often hard to find food, we knew this was our calling – not just for us, but for grilled cheese eaters everywhere."

Cheeseborg is a dedicated, hands-free grilled cheese making robot that will satisfy cheese cravings at all hours. The Google Assistant SDK and AIY Voice Kit provide voice activation. Both "work fantastically with Raspberry Pi 3 Model B+," says Taylor. Their

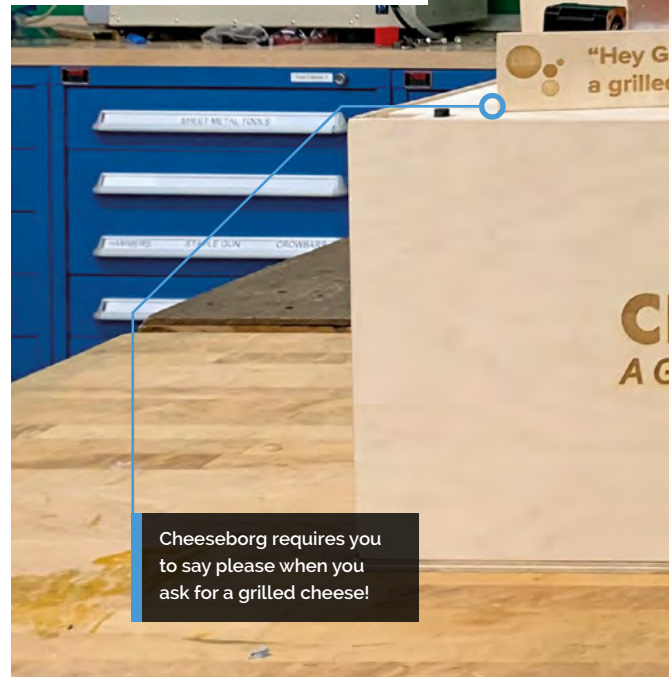

Cheeseborg requires you to say please when you ask for a grilled cheese!



**Warning!**  
Hot mess!

Goey butter is messy stuff. Be prepared for your kitchen, as well as your grilled cheese sandwich, to be buttered all over!



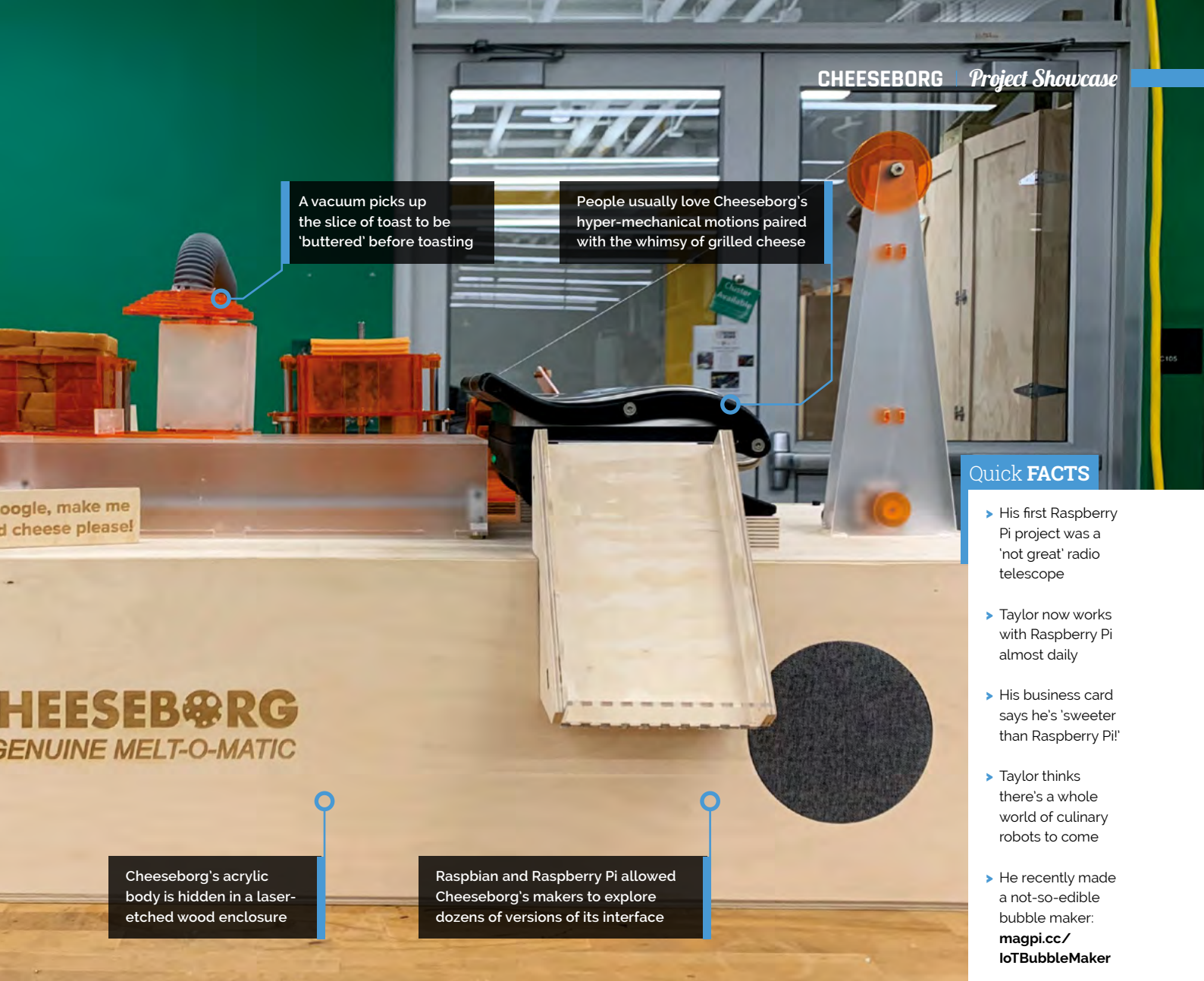

A vacuum picks up the slice of toast to be 'buttered' before toasting

People usually love Cheeseborg's hyper-mechanical motions paired with the whimsy of grilled cheese

Hey Google, make me a grilled cheese please!

**CHEESEBORG**  
A GENUINE MELT-O-MATIC

Cheeseborg's acrylic body is hidden in a laser-etched wood enclosure

Raspbian and Raspberry Pi allowed Cheeseborg's makers to explore dozens of versions of its interface

**Quick FACTS**

- ▶ His first Raspberry Pi project was a 'not great' radio telescope
- ▶ Taylor now works with Raspberry Pi almost daily
- ▶ His business card says he's 'sweeter than Raspberry Pi!'
- ▶ Taylor thinks there's a whole world of culinary robots to come
- ▶ He recently made a not-so-edible bubble maker: [magpi.cc/IoTBubbleMaker](http://magpi.cc/IoTBubbleMaker)



- ▲ The Cheeseborg even features a mini chute for delivering the sandwich
- ◀ We do love a grilled cheese sandwich and this one looks pretty tasty

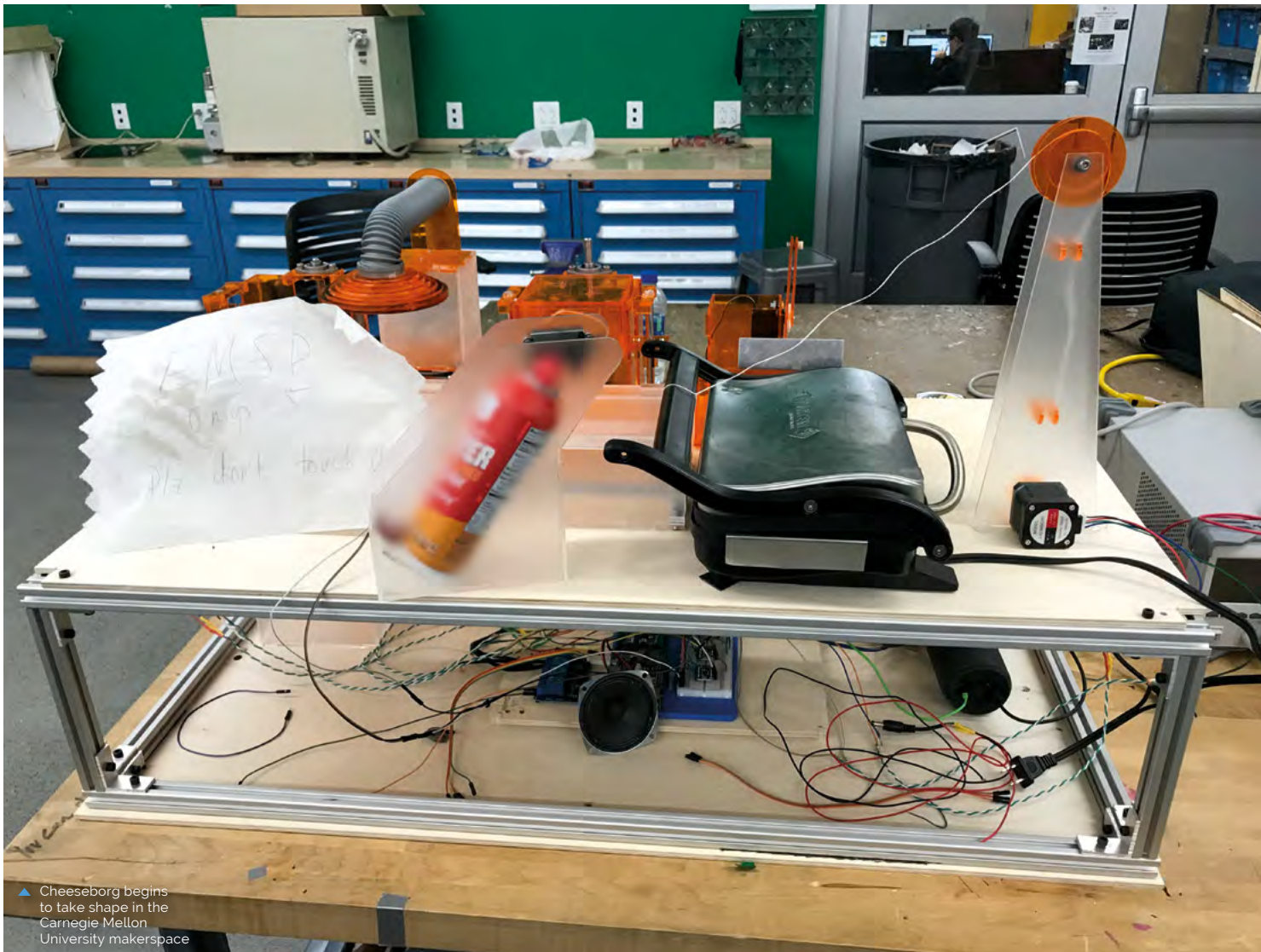

▲ Cheeseborg begins to take shape in the Carnegie Mellon University makerspace

“ A dedicated, hands-free grilled cheese making robot that will satisfy cheese cravings at all hours ”

customised build of Google Assistant, sourced from the AIY Kit and Google Cloud SDK, allowed them to add some personality: you can ask about the weather while awaiting your sandwich.

Raspberry Pi also triggers its assembly, while motor control circuits and motion are operated by Arduino Mega. Taylor reveals, “We wrote our own code, but also used open-source Arduino libraries,” dictating timings and the motions for each step.

Carnegie Mellon’s Department of Mechanical Engineering’s makerspace provided hardware commonly used in 3D printer kits, such as stepper motors and linear motion carriages. However,

the acrylic parts were designed and laser-cut by Mitchell, Evan, and Taylor. Impressively, the project cost just \$200 to build, and took approximately eight weeks to complete.

### Taste test

The team undertook three weeks of customer research to identify grilled cheese preferences. “There was a lot of going back and forth between our build, CAD software, and laser cutter, adjusting parts as we learned more about the mechanics of bread and cheese,” recalls Taylor. They spent days just tuning the grilling time to get the gooeyness and crispiness just right, while experiments in applying the butter resulted in a thoroughly dairy-spattered makerspace.

Eventually, they went with a spray ‘butter’. “We aimed at the cooking plates and activated just before the bread was moved to be cooked,





- ▲ Cheeseborg's makers earned even more goodwill from their classmates when they brought it along to their design expo
- ▲ Taylor, Mitchell, and Evan at 5am, just after Cheeseborg was finally finished

thus buttering both sides [not to say the rest of Cheeseborg]. In the end, we found if we just spray the grill plates every five [sandwiches] or so, it still is enough to make a crispy, gooey grilled cheese!

“As with all good projects, we had no idea if it was going to work until 4am the morning before it was due, when Cheeseborg popped out its first fully hands-free grilled cheese sandwich.”

### Making your own grilled cheese robot

Interest levels online have been such that Taylor and his colleagues may consider offering a kit version. While he cautions that there's a huge amount of fine-tuning involved, he says, “If anyone out there is building a grilled cheese robot, we're more than happy to offer any insights.” Contact him at [tabb.me/grilledcheese](http://tabb.me/grilledcheese). 

## Making your own grilled cheese robot



- 01** This is the ideal project with which to use Google Assistant in Google's Raspberry Pi AIY Voice Kit, and the Google Cloud SDK for voice activation. Experiment with phrases to initiate the snack-assembly process.



- 02** Raspberry Pi now hands over to Arduino. Use Arduino Mega to control the robot that assembles the grilled cheese sandwich once Raspberry Pi instructs it. Open-source Arduino libraries are invaluable here.



- 03** Use tongs or suction to pick up slices of bread and add a chute for the snack's delivery. However, positioning bread to be buttered and adding cheese takes patience.

# Bit Time – Rotary Dial Phone Project

A unique project in Essex explores how all ages engage with the tools that enable us to communicate, including using two upcycled retro phones. **Nicola King** dials in



MAKER

**Dave Norton and Laura Trevail**

Dave is a Digital Artist and Drama Practitioner, and his work ranges from large-scale interactive installations to live theatre performed in a virtual world. Laura is an Artist and Context Strategist with an outdoor theatre and live-art background.

[magpi.cc/bittime](http://magpi.cc/bittime)

**T**he Rotary Dial Phone project is part of a wider initiative called **Bit Time – a project that has been running in Basildon over recent months**. Lead artist Laura Trevail explains, “Bit Time is an intergenerational project, combining the skills and knowledge of the very young with those of our elders. As artists and facilitators, we’ve been bringing together these ideas and possibilities into playable works that in themselves keep that momentum going. These are projects about communication technology, but they are also communication technologies in themselves. By interacting with the art, you are interacting with each other.”

## Cold calling

So, the retro phones... where do they fit into this story? Phone project artist Dave Norton says, “The

inspiration for the question/answer phones came from a desire to build a device that lets you share a message with someone you’ll never meet. A digital time capsule of anonymous thoughts, advice, stories, and memories that could be listened to by anyone. You have no idea who might hear your message and how it could affect them.”

He explains how the system works: “You walk past a phone and it starts ringing, you pick it up and the operator asks you to answer a question, e.g. ‘what was your first phone?’, ‘what will a phone of the future look like?’ A ‘recording’ light comes on and you leave your message and hang up. Later on, you see another phone that also rings as you walk past; you pick it up and it plays back a random message left by someone else.”

A motion detector identifies when someone walks past, while a push-button detects when the

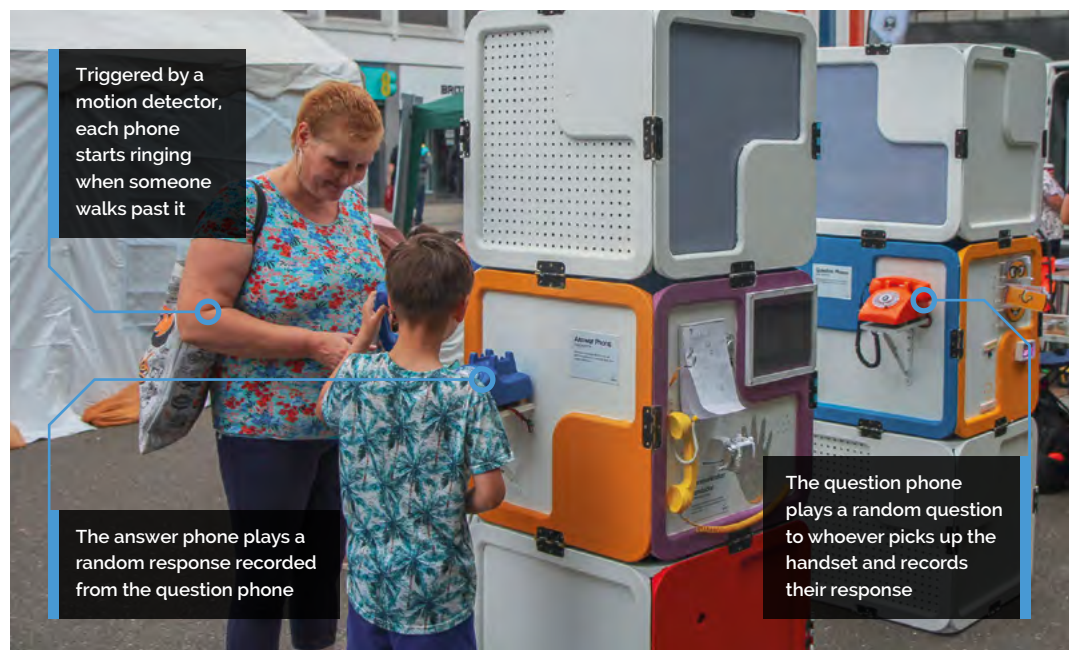

Triggered by a motion detector, each phone starts ringing when someone walks past it

The answer phone plays a random response recorded from the question phone

The question phone plays a random question to whoever picks up the handset and records their response

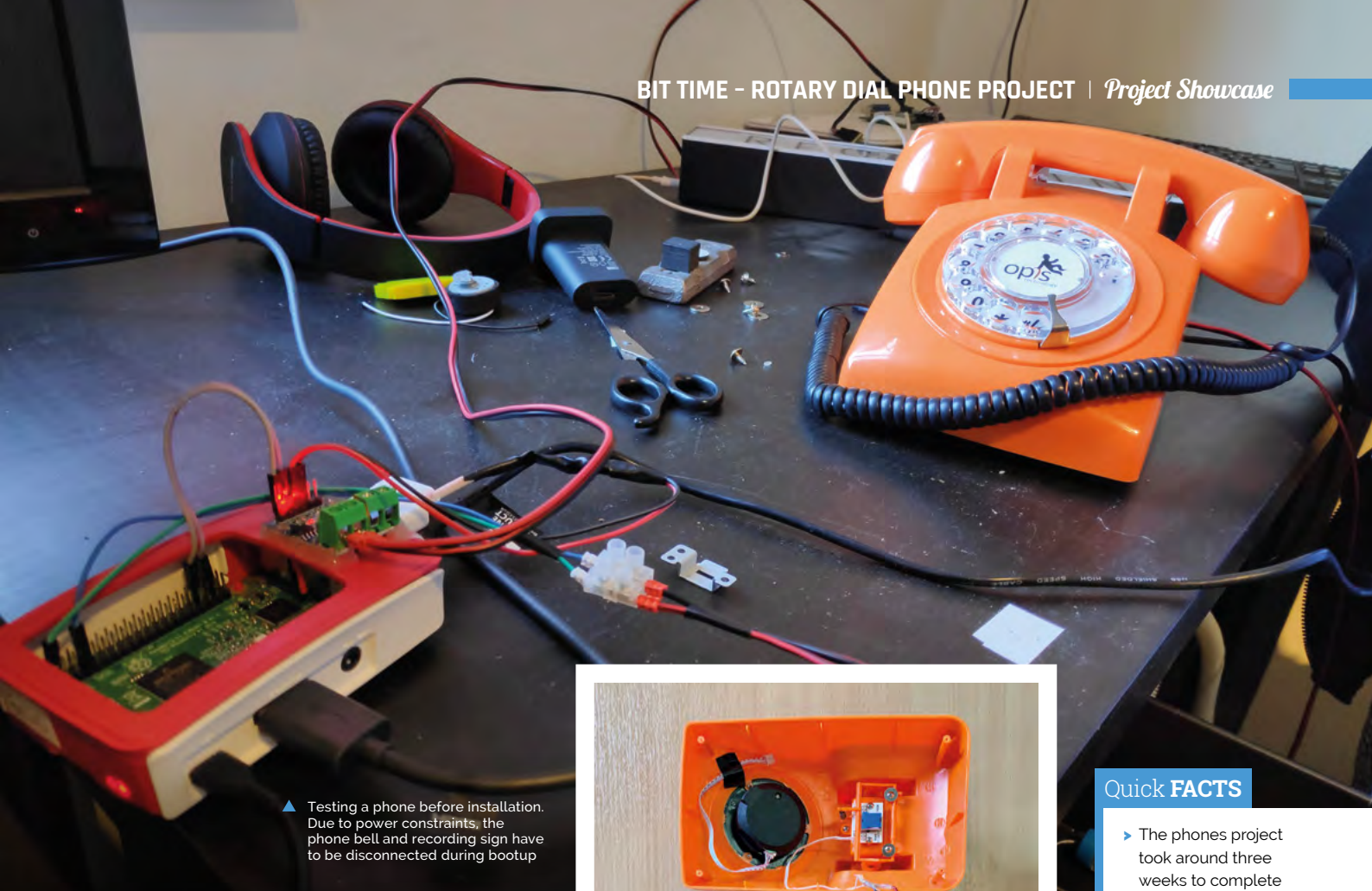

▲ Testing a phone before installation. Due to power constraints, the phone bell and recording sign have to be disconnected during bootup

receiver is lifted. The phone's mic and speaker are hooked up to a Raspberry Pi, which chooses a random audio file question to play. "The mic starts recording the user's message for 15 seconds, or until they hang up, then the whole process restarts. The answer phone works in a similar way, but only chooses random audio files to play back."

Since the installation needed to work in any kind of location, it couldn't rely on WiFi to transfer audio files between the phones, particularly as the audio files needed to be checked manually before they could be shared with the public. "I ended up having to code a 'syncing' mode, which is activated when a USB drive is inserted into Raspberry Pi, which automatically transfers all the audio files to the drive," reveals Dave.

“ Some people just hang up straight away, some people audibly freak out ”

### You talkin' to me?

The Bit Time project, including the rotary dial phones, ultimately became an exhibition which toured Basildon in the summer of 2019. Dave says, "There's something really unburdening about being anonymous, and something really pleasing about being given an open platform to speak your



▲ Dave says it was easy to snip the wires from each phone's speaker, mic, and hang-up button and connect them to Raspberry Pi

mind. I loved the idea that the installation starts as a blank slate and, as it travels to different events and locations, it collects a mixture of stories and thoughts and shares them with anyone who cares to listen, something akin to a travelling storyteller."

He says the phones elicited a variety of reactions. "Some people just hang up straight away, some people audibly freak out that they're actually being recorded, some yell bizarre phrases, but most people genuinely answer the question. No two answers have been similar and it makes for some really interesting listening... We've ended up with hundreds of varied audio responses – it would be lovely to build some sort of audio installation using all the clips." 

### Quick FACTS

- ▶ The phones project took around three weeks to complete
- ▶ Basildon Library Creator Space provided a location to construct the Bit Time artwork
- ▶ A 5V solenoid is used to ring each phone's bell
- ▶ Dave programmed each Raspberry Pi using Python
- ▶ He suggests the phones could be used in the foyer of a venue after an event, to glean honest views from attendees

# NeoPixel LED Mirror



**Alex Schepelmann**

MAKER

A DIY YouTuber who dabbles in Raspberry Pi, robotics, electronics, and 3D printing. During the day, he's an engineer working on robotics and computational modelling.

[magpi.cc/supermake](http://magpi.cc/supermake)

Your face in lights thanks to 576 LEDs. **Rob Zwetsloot** puts on his best hat and takes a look at this 'mirror', and himself

**M**agic mirrors seem to now be a rite of passage for many makers and Raspberry Pi aficionados. It's a fun project, but we think this LED mirror from Alex Schepelmann is a little more striking.

"The project uses a Raspberry Pi 3B+, a Raspberry Pi Camera [Module], Python, 3D printing, and 576 NeoPixel LEDs to create an interactive art piece that shows you your reflection in 'low resolution' by lighting up a grid of LEDs," says Alex.

In essence, it's taking your picture using a Raspberry Pi Camera Module, converting it to a low-resolution picture, and then setting the LEDs to the same colour as the individual pixels in the resulting image. Magic? Yes. Practical? No. Fun? Absolutely.

## Mirror art

Where did such an idea come from, though? "I was inspired by the various 'analogue mirrors' made by Daniel Rozin," Alex reveals. "The Children's



▲ Alex eventually got a laser cutter to help speed up production – like for these mounting grids

Museum of Pittsburgh, where I built an exhibit for a Systems Engineer class that I took during graduate school, had one of Mr Rozin's mirrors on display. The mirror at the Children's Museum used blocks of wood and servo motors to display images of people who were standing in front of it in low resolution. Ever since then, I've been following Daniel's work, and wanted to build one of his mirrors myself. I

“ Shows you your reflection in low resolution by lighting up a grid of LEDs ”

thought that such a project would be perfect for my YouTube channel ([magpi.cc/supermake](http://magpi.cc/supermake)), because it would allow me to put my own twist on the concept while simultaneously teaching people about programming, 3D printing, laser cutting, and more!”

The build itself has an impressive list of components. Alex created a custom prototype



▼ A Raspberry Pi handles it all, although another computer is on hand for project info

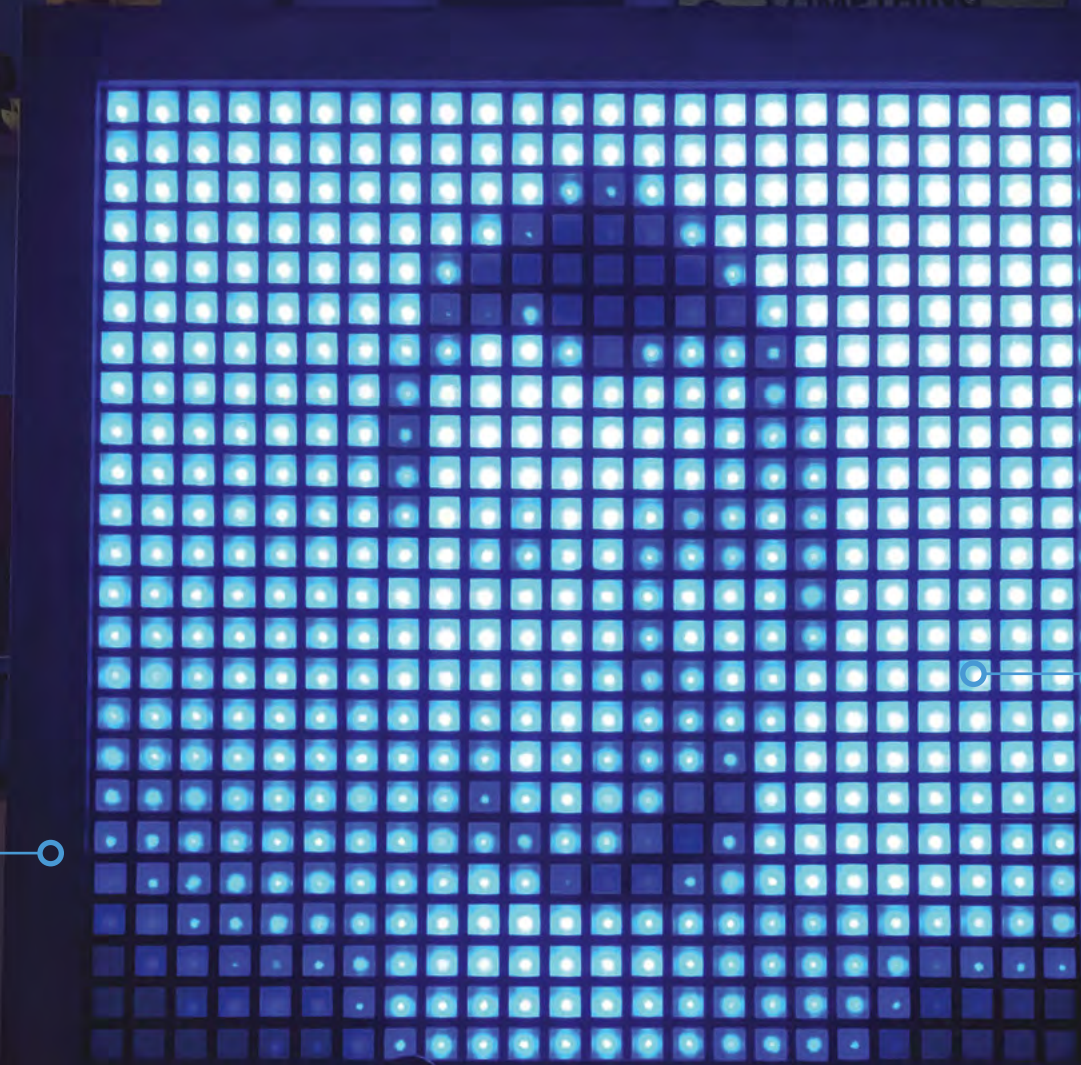

Anyone in front of it will be displayed in the mirror

The mirrored images are low-resolution, but you can still make out what they're of!

## Mirroring with LED

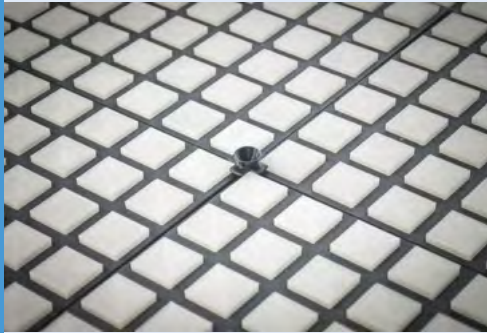

**01** Camera settings are locked as the code starts, before capturing the image and selecting a small region of 24x24 pixels.

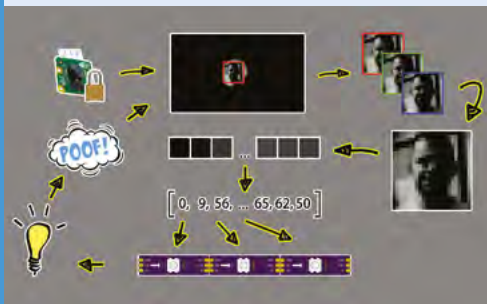

**02** This image is then converted to greyscale, after which the code extracts one of the image's colour planes from the image as an array. This array contains the brightness information for each pixel of the extracted 24x24 region. This square array is then reshaped into a 1x576 vector, and brightness values are assigned to LEDs.



**03** Brightness values are used to light up each pixel, after which the image is cleared and the image capture/display process are repeated. In order to be able to display images as quickly as possible, the Python code is optimised to operate on vectors and to minimise the number of for loops.



▲ People were taking selfies of themselves with their 'reflection'

PCB, 3D-printed and laser-cut several parts, and connected 24 strips of 24 LEDs to make the magic 576 number. A Raspberry Pi was used to power it due to its size, ability to run Python and address all the LEDs, along with the Raspberry Pi Camera Module which makes it all possible.

### On display

With such an unconventional project, you might expect some issues when it was finally unveiled. However, it went down very well.

“The project made its debut at the 2019 Cleveland Maker Faire, where it ran for over eight hours during the event without a single hiccup,” says Alex. “An advantage of being able to run everything via Python code is that I could adjust camera settings on the fly based on lighting conditions in the location where I was at,

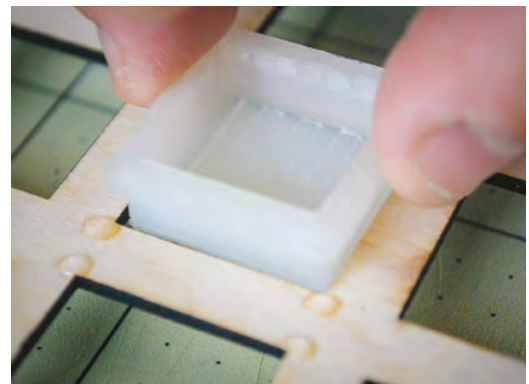

▶ Each LED cover was 3D-printed out of clear PLA and then glued into a laser-cut mounting grid



▲ Diffuser plates are required on all the LEDs – a job for a glue gun

#### Quick FACTS

- ▶ Nearly 600 parts were 3D-printed or laser-cut for the mirror
- ▶ Version two may use full RGB colour
- ▶ Alex spent nearly three years on the project
- ▶ The display could be used for signage and QR codes as well
- ▶ You can get the code and design files at [magpi.cc/ledmirrorgit](https://magpi.cc/ledmirrorgit)

“ People were fascinated by the mirror and enjoyed moving their limbs and making faces in front of it ”

making sure that the mirror clearly displayed the reflections of visitors throughout the day.

Maker Faire attendees interacted with the mirror and stopped by the Super Make Something booth to learn more about the YouTube channel, Raspberry Pi, and Python programming. “One of my favourite observations I made during this event is that the mirror captured the interest of an audience with a broad age range – people between the ages of 5 and 65 were fascinated by the mirror and enjoyed moving their limbs and making faces in front of it, excited to see what would happen.”

If you’ve not managed to see the mirror in person, all is not lost. Alex has been in discussions to add the mirror to the Great Lakes Science Center, very hopefully with upgrades. Look out for more info on his YouTube channel. [M](#)

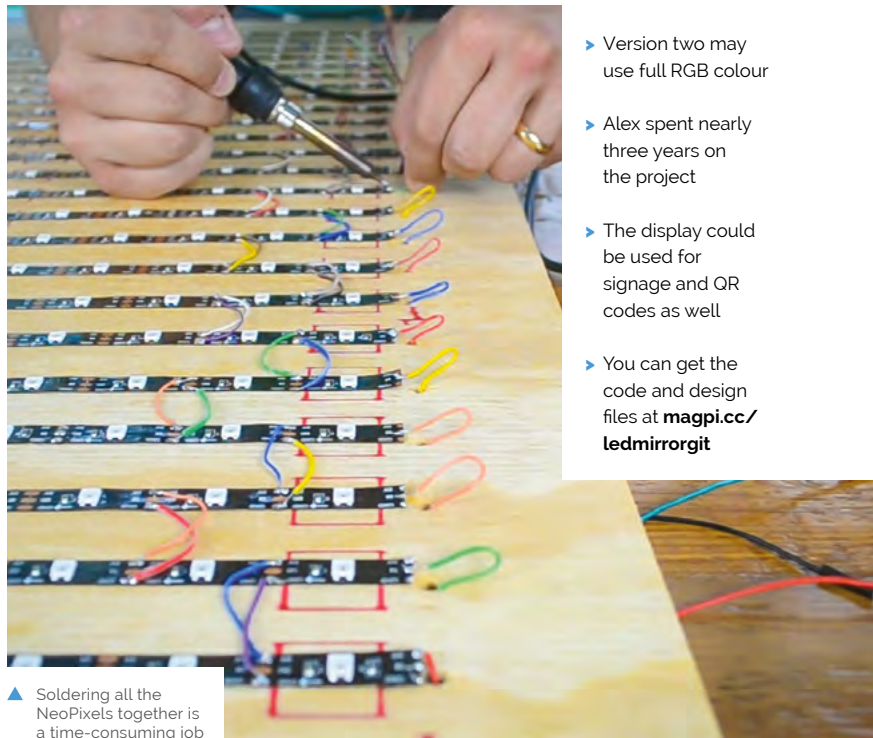

▲ Soldering all the NeoPixels together is a time-consuming job

# AdventurePi

Zach Levine's portable arcade project lets you choose your own AdventurePi, as **David Crookes** explains



**Zach Levine**

Zach is a programmer, designer, tinkerer, YouTuber, and howchoo founder living in Tampa, Florida.

[magpi.cc/adventurepi](http://magpi.cc/adventurepi)

**A**s big fans of gaming, Zach Levine and his brother ended up owning a good number of video game consoles, including the Game Boy, Virtual Boy, NES, Nintendo 64, and Sega Saturn. “But we also frequented the arcade at the local bowling alley quite often,” Zach tells us, and this love of coin-operated gaming machines never left him.

As such, when pondering his next project with a Raspberry Pi, he decided to create a portable gaming device that would be as robust as an arcade machine. “A lot of people my age move around a lot or live in apartments and no one really wants to lug around a free-standing cabinet, so I looked to create a device that would feature full arcade controls.”

In fact, Zach ended up creating two different versions of his project. As well as an Arcade Edition that features a removable panel containing arcade buttons and a removable joystick, he produced a Console Edition that uses a foam block insert with cutouts for controllers and accessories.

“My primary goal was to make the project as accessible as possible and introduce more people to Raspberry Pi, hobby electronics, and retro gaming,” he says, opting early on to use the



▶ The Console Edition is essentially a Raspberry Pi with RetroPie installed connected to a display in a case with foam inserts for controllers and accessories

RetroPie OS ([retropie.org.uk](http://retropie.org.uk)) which allows games originally made for older systems to be enjoyed with minimal fuss via emulation.

## Hardcore gaming

Since RetroPie does not yet work on a Raspberry Pi 4, Zach had to use the 3B+ model instead. Planning proved to be the trickiest part of the setup, but he knew he needed a display that could run on either 12V or 5V, and a single power supply

“ No one really wants to lug around a free-standing cabinet ”

that would output enough amperage to run the screen and Raspberry Pi simultaneously for hours.

“From there, it was a matter of finding a sturdy case that had a removable panel for the Arcade Edition and a foam insert for the Console Edition,” he says. A Nanuk 910 waterproof hard case worked well, requiring only a little bit of shaving to the inside with a box cutter so that the screen would fit nicely in the lid, while allowing room for the wires.



▶ To avoid the controller smashing into the screen when the case is closed, the joystick unscrews for easy storing





The screen, from Sunfounder, runs on either 5V or 12V and fits snugly in the hard Nanuk 910 case (a Nanuk 915 offers more room)

A cased Raspberry Pi 3B+ sits on top of an iMuto 30,000 mAh portable power bank

Illuminated red buttons are fitted to a removable custom-cut panel together with a detachable shaft joystick made by arcade parts maker Sanwa Denshi

### Quick FACTS

- ▶ The project cost about \$250, overall
- ▶ There are two versions: Arcade and Console Editions
- ▶ It displays to a 13.3-inch screen
- ▶ It uses RetroPie for emulation
- ▶ Strong nylon fasteners secure the components

"I found some slim 90 degree cables normally used on drones, because there wasn't the space for normal micro USB and HDMI cables," he says.

### Joystick joy

For the Arcade Edition, Zach had to essentially build a USB controller. "I made use of illuminated buttons and a joystick connected to a small PCB that turned the setup into a USB device," he explains. He took inspiration from Pimoroni's Picade cabinet. "The controls use the same layout because I figured they'd worked things out already."

Even so, Zach encountered a problem that almost killed the project before it started: how to add a joystick within a closable case. "I messed around with a few hinging mechanisms and then found a company that makes a removable joystick," he says of the fortunate solution.

As for the Console Edition, that has been a case of cutting the foam to house controllers, chargers,

wires, and other gaming peripherals that can connect to the Raspberry Pi, but the fun isn't stopping there. Zach believes AdventurePi will eventually be developed as a much smaller version using a custom power supply. "I'd also like to add a power button that automatically shuts [Raspberry] Pi down when the case is closed," he says. [M](#)



- ◀ Slim micro USB and HDMI FPV cables were needed because of the small amount of space between the display ports and the case

# Reachy

Meet the expressive and flexible open-source robot powered by a Raspberry Pi. **David Crookes** reaches out



MAKER

**Pierre  
Rouanet**

Pierre Rouanet studied human-robot interaction and AI for eight years in the INRIA Flowers research lab, where he obtained his PhD. He co-founded Pollen Robotics to imagine new robotic creatures.

[pollen-robotics.com](http://pollen-robotics.com)

**S**ay hello to Reachy – a humanoid robot that you’re likely to love to bits when you first set eyes on it. Blessed with futuristic styling and able to carry out many tasks with precision, it can interact with the environment and with us humans, making for a rather endearing creation.

Which part of Reachy you’ll love, however, will mostly depend on the configuration you decide to buy – assuming you have enough money, given that the prices start at €9990.

The basic model, for instance, comes with just a torso and one arm, while ‘expressive’ adds a Johnny Five–like head. An advanced option gives Reachy an extra arm, but in each case there’s a fine heart beating inside: a Raspberry Pi 4 running the Raspbian operating system.

## Ideal choice

According to Pierre Rouanet, co-founder and CTO of Reachy creator Pollen Robotics, the decision to use Raspberry Pi 4 came after much debate. “We wanted to provide a simple and well-known setup with a supportive community that would let our users quickly understand, adapt, and modify the basic tool we were providing. Raspberry Pi has always been a very good solution for this.”

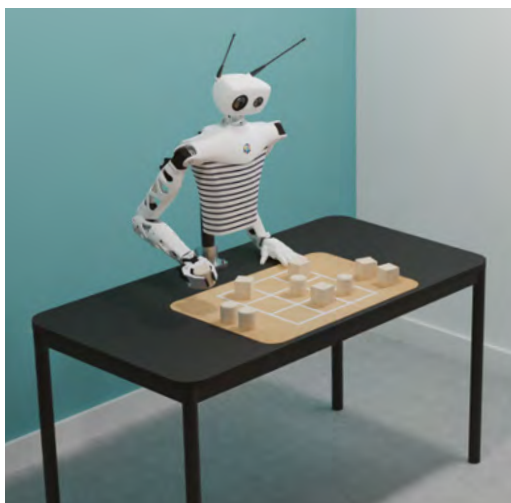

▶ Reachy played tic-tac-toe against humans at CES 2020, running entirely on Raspberry Pi. Reachy would image-analyse the board, recognise the pawns, and use simple AI to choose what to play next. It would use higher-level control to grasp a pawn and place it

Reachy is open-source and developers can program it using Python, which opens up the possibilities of what it can potentially do. Indeed, Pollen Robotics initially created the robot to help researchers study arm-control in humans, but it’s evolved a lot since.

“When we started Reachy in 2016, our former researcher colleagues had wanted to see how an amputee could easily control a prosthetic arm, and they needed something that could closely reproduce human motion and shape,” Pierre says. “But we developed new features, including using machine learning for control. We also wanted to work on its ease-of-use to extend the range of its potential users.”

“ We developed new features, including using machine learning for control ”

To that end, Pollen Robotics has pre-installed its own Python API and some extra tools for communicating with all the motors and sensors via USB-to-serial communication.

“[Raspberry] Pi is actually running the whole synchronisation loop that retrieves all of the sensors values, and it publishes new commands for the effector (it runs at ~100Hz for Reachy, which is higher than most synchronisation loops in humans),” says Pierre. “On top of that, we run a higher-level application.”

## Machine learning

Key to the robot is its built-in artificial intelligence. “We wanted to provide high-end and efficient tools for machine learning,” Pierre continues. “Our users require lots of power to perform analysis from the sensors, such as live object recognition and tracking, voice recognition, complex trajectory generation, and so on.”

As luck would have it, work on Reachy coincided with the arrival of the Google Coral AI accelerator

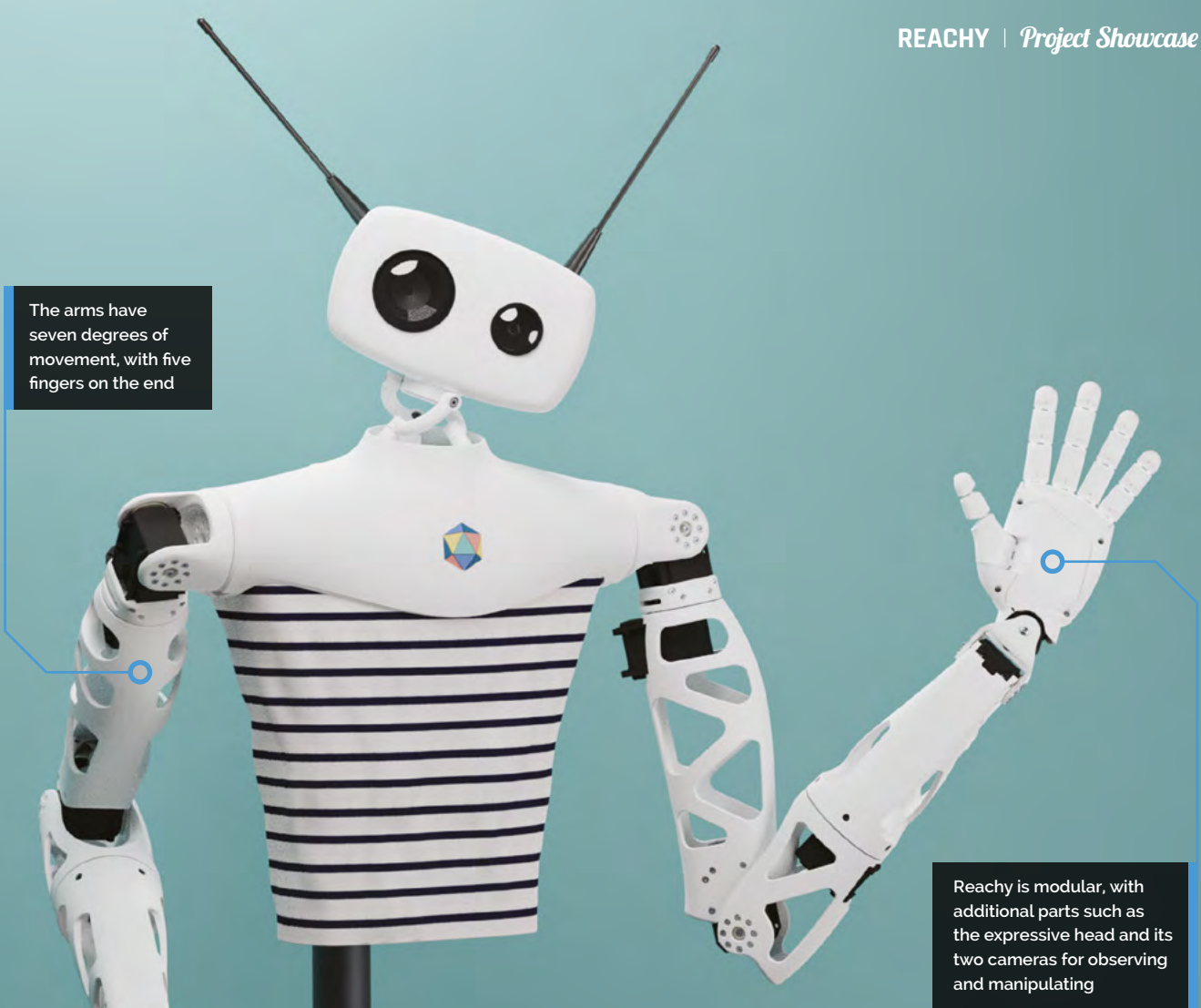

The arms have seven degrees of movement, with five fingers on the end

Rechy is modular, with additional parts such as the expressive head and its two cameras for observing and manipulating

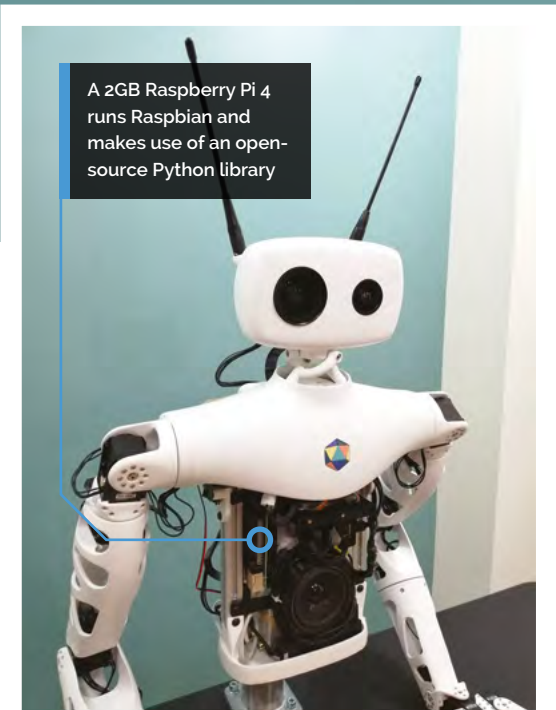

A 2GB Raspberry Pi 4 runs Raspbian and makes use of an open-source Python library

and the new USB 3 ports in Raspberry Pi 4. “It was perfect timing,” says Pierre. “We could run all the machine learning we needed, while still providing a simple ready-to-use setup and on top of that, we don’t need to rely on a cloud service.”

Pierre says Rechy currently shines best when it is manipulating simple objects and interacting with humans. As such, it’s primarily intended for use in food and customer service, research, and development. But Pollen Robotics envisages a lower-cost version for hobbyists at some stage which would make for a rather exciting development for the Raspberry Pi community. “This is definitely something that I would like to encourage and see emerge,” Pierre says. [W](#)

### Quick FACTS

- ▶ Rechy is designed to be plug-and-play
- ▶ It includes a microphone and speaker
- ▶ The innards are covered by fabric
- ▶ Google’s Coral AI accelerator is also inside
- ▶ Only a handful are initially being made
- ◀ The software, design of all 3D parts, and the data used to pre-train Rechy on some tasks are all open-source

# El Carrillon

Tired of hearing the same tune year after year, two makers hacked the bells of an enormous tower to ring the changes. **Rosie Hattersley** hears how



**MAKER**  
Mariano  
Martinez Peck  
& Gerardo  
Richarte

Buenos Aires-based systems engineer and instantiations software specialist Mariano enjoys Raspberry Pi-based IoT projects. Gerardo founded satellite and geospatial solutions company Satellogic. Raspberry Pi and Arduino reignited his love of electronics.

@MartinezPeck  
satellogic.com

**M**ost Raspberry Pi projects we feature debut privately and with little fanfare – at least until they’re shared by us.

The El Carrillon project, however, could hardly have made a more public entrance. In September 2019 it was a focal point of Argentina’s 49th annual Fiesta Nacional de la Flor (National Flower Festival), where its newly overhauled bell tower proudly rang out a brand-new, Raspberry Pi-enabled tune.

Many years ago, festival organisers created custom hardware with a PIC (programmable interface) microcontroller to control 18 tuned bells. Each bell is associated with a musical note, from A3 to D5 with all the semitones. Until its long overdue update, the tower’s 18 bells had



▲ The El Carrillon bell tower forms a striking backdrop to the flower festival and other cultural events

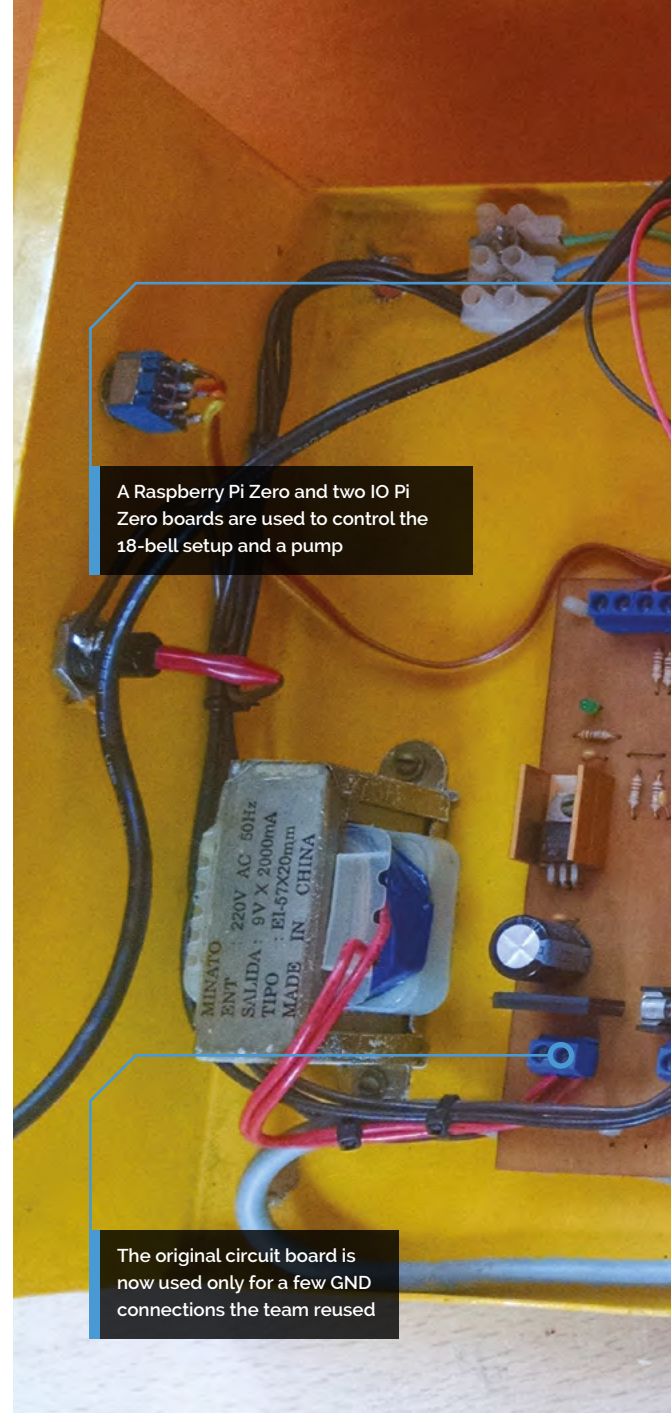

A Raspberry Pi Zero and two IO Pi Zero boards are used to control the 18-bell setup and a pump

The original circuit board is now used only for a few GND connections the team reused

rung the tune to *Ayer*, also known as *Yesterday* by The Beatles. They now have a brand-new repertoire of MIDI-based tunes, including the theme from *Star Wars*.

For Gerardo Richarte, the originator of the project, there was a little extra pressure: his dad is on the board of the NGO that organises Fiesta Nacional de la Flor, and challenged his son to come up with a way to update the bells so different songs could be played.

## Ringling the changes

With the challenge accepted, Mariano Martinez Peck explains, “We chose Raspberry Pi because it was inexpensive, yet powerful enough to run Linux, Python, and VA Smalltalk. We could find ready-made HATs that actually matched the pinout

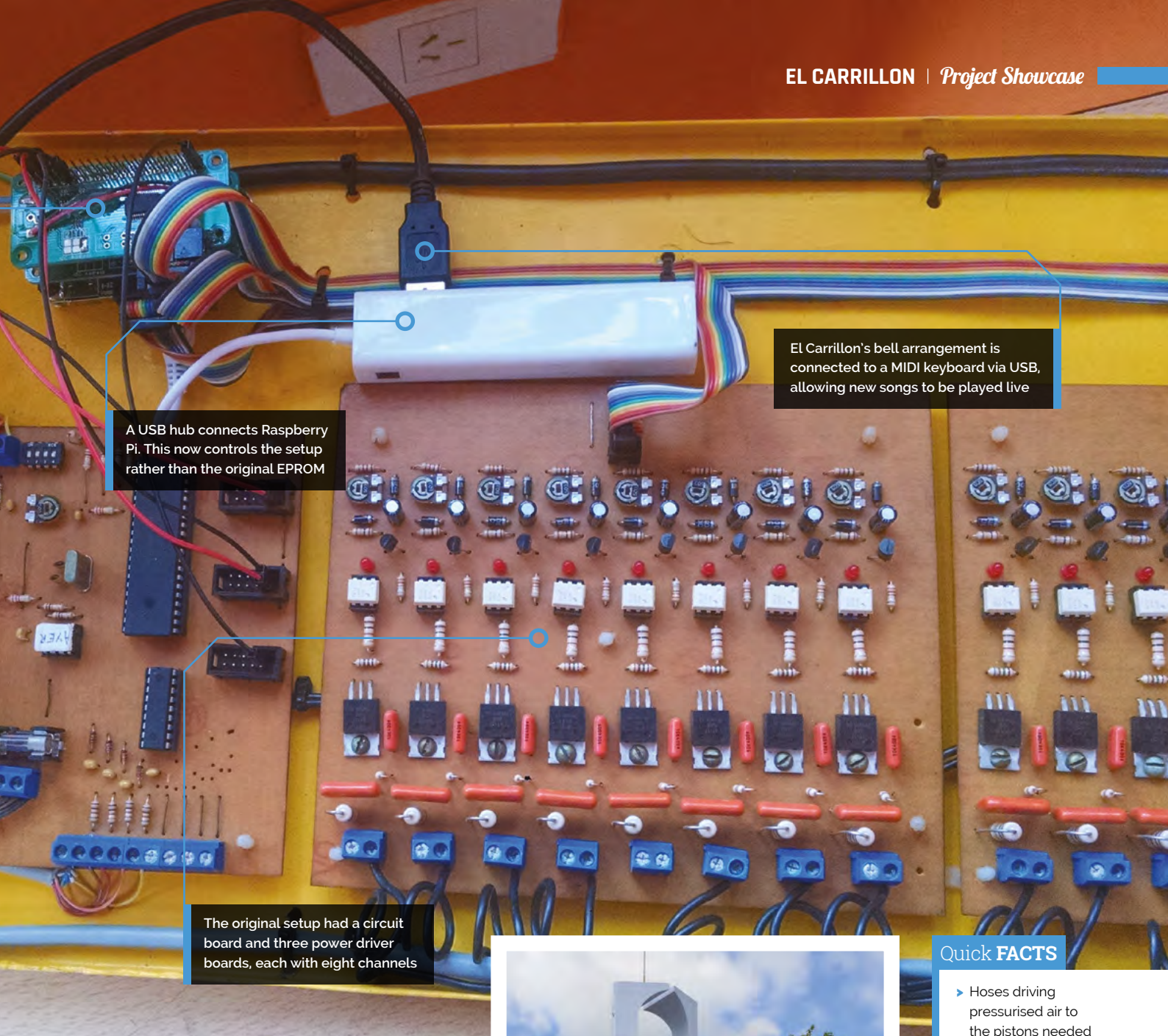

A USB hub connects Raspberry Pi. This now controls the setup rather than the original EPROM

El Carrillon's bell arrangement is connected to a MIDI keyboard via USB, allowing new songs to be played live

The original setup had a circuit board and three power driver boards, each with eight channels

**Quick FACTS**

- ▶ Hoses driving pressurised air to the pistons needed overhauling
- ▶ Identically mapping the bells using an 'LED piano' helped with testing
- ▶ They used FluidSynth MIDI software to check the tunes
- ▶ The attached keyboard can record the chimes performances
- ▶ Having a fixed deadline drove the makers on

“ A website that allowed control, configuration, and playback of MIDI songs on the bell tower ”

of the existing flat cables without much hacking, and only a minimal amount of other hardware was needed. In addition, there was plenty of documentation, materials, tutorials, and GPIO libraries available.”

The project aim was to be able to run a mobile-friendly website within Raspberry Pi Zero that allowed control, configuration, and playback of MIDI songs on the bell tower. “In addition,



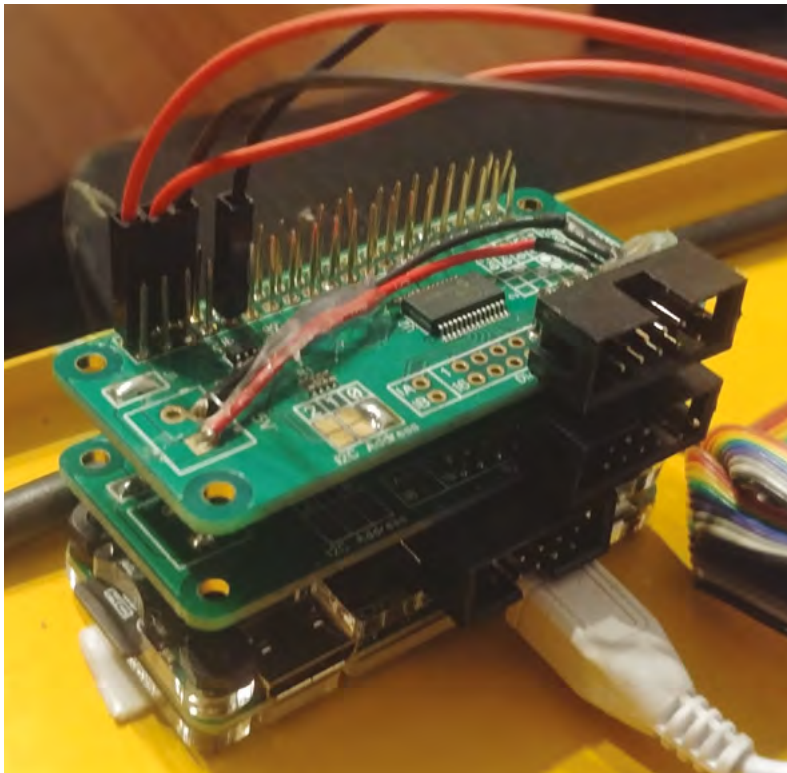

▲ Two IO Pi Zero boards are stacked on top of a Raspberry Pi Zero to add extra connections



▲ A MIDI keyboard is connected to the setup, enabling a user to play live and record songs

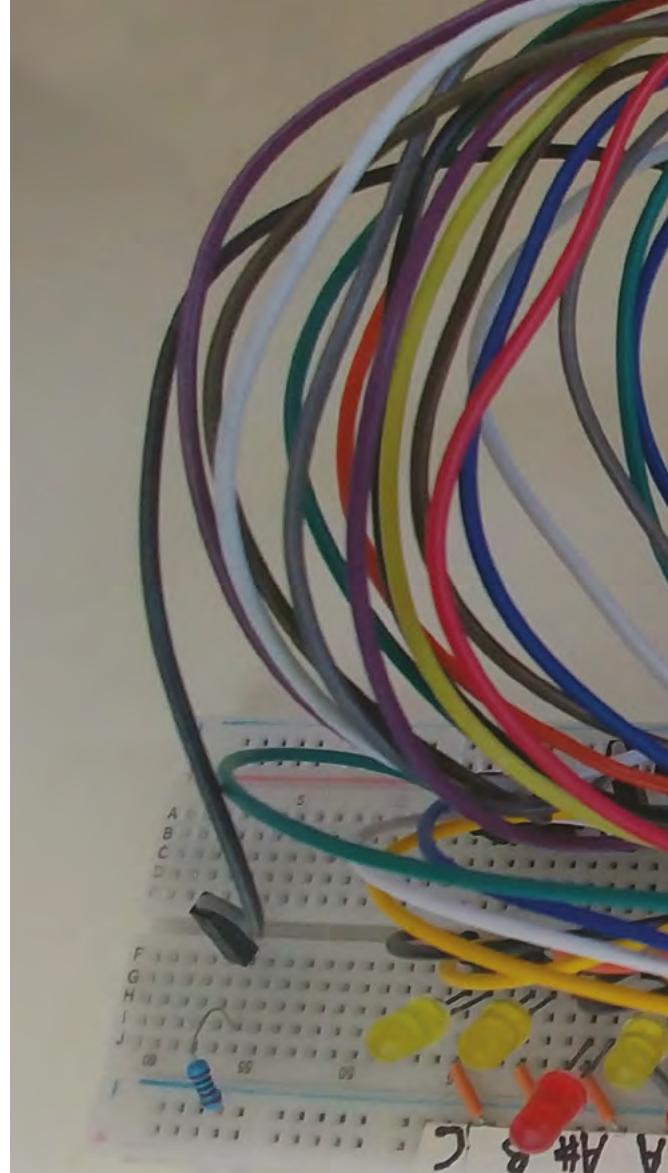

▲ To test the setup away from the bell tower, a piano layout of LEDs was created, each LED representing a note / bell

we wanted to allow live playing from a MIDI keyboard,” says Mariano. The project developed as a live test and iteration update, but the final build only came together when Mariano and Gerardo’s moment in the spotlight arrived and El Carrillon rang out the first new tunes.

### Coding a classic

The decades-old chimes were controlled by assembly code. This was superseded by Python when the team made the switch to Raspberry Pi Zero. Mariano explains, “Raspberry Pi allowed us to use Python to directly interface with both the old and new hardware and get the initial project working.”

However, the Python code was itself replaced by object-oriented VA Smalltalk code – an environment both Mariano and Gerardo are adept at using. Mariano says, “Smalltalk’s live programming environment works really well for fast, iterative development and makes software updates quick and easy without the need for

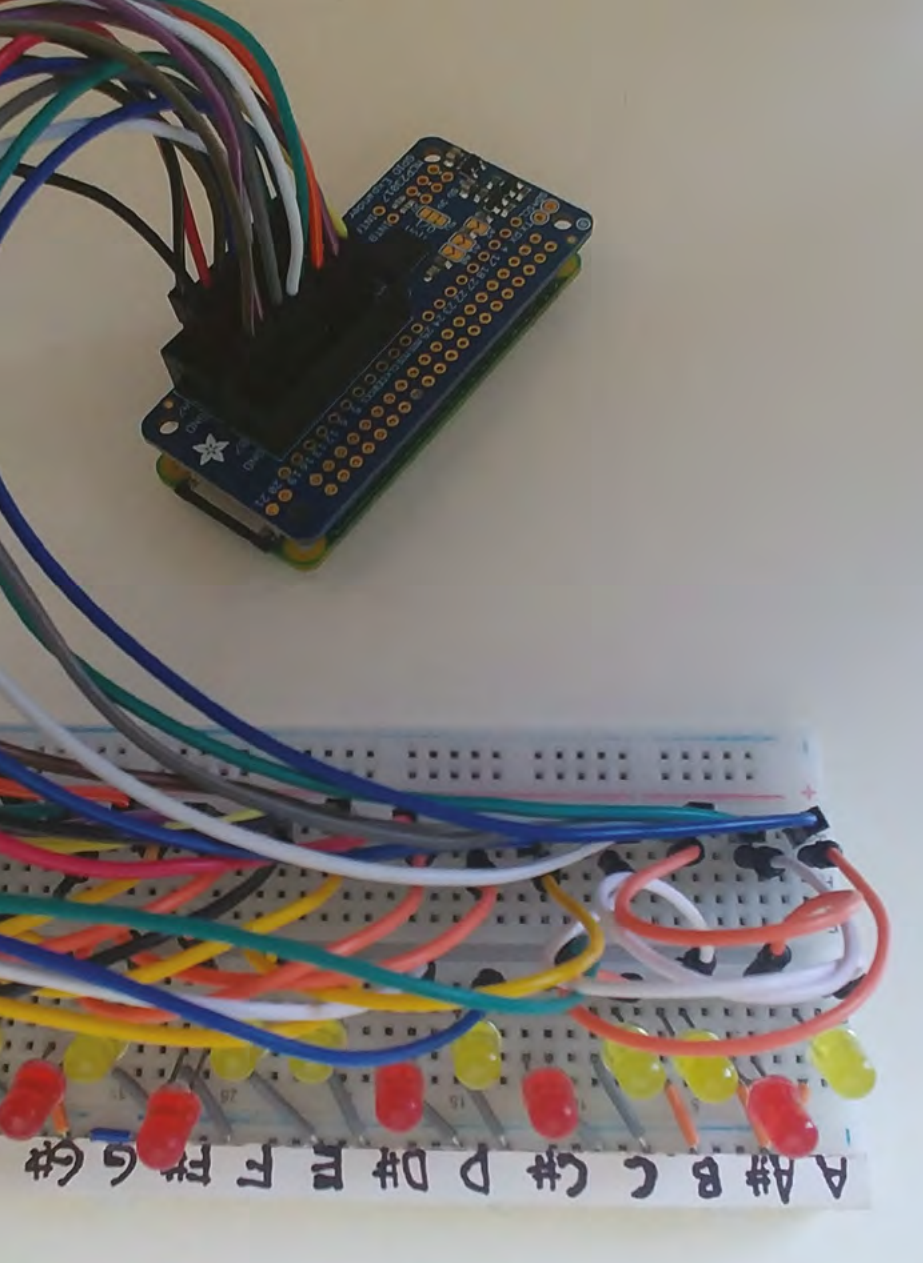

“ El Carrillon's bells can now play any MIDI file on Raspberry Pi, and the notes of the song will be mapped to the tuned bells ”

recompilation that lower-level languages [such as assembly or C/C++] would need.”

El Carrillon's bells can now play any MIDI file on Raspberry Pi, and the notes of the song will be mapped to the tuned bells. However, as the testing process revealed, some songs are more recognisable than others when reproduced on chimes.

A final feature enabled Gerardo to bag some brownie points with his father-in-law. He recently added a web interface for controlling, configuring, and playing songs, meaning the bells can now be controlled remotely and the song selected via a smartphone app. [M](#)



### Warning! Heavy objects

Church bells can weigh more than a tonne and are maintained by specialists.

[magpi.cc/churchbells](http://magpi.cc/churchbells)

## Make your own chimes

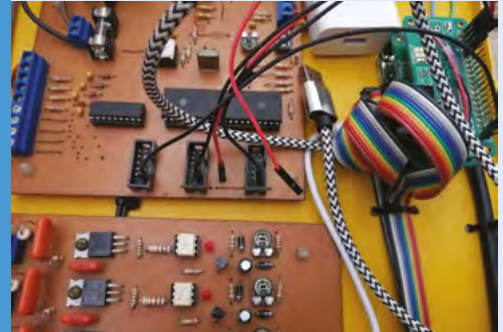

**01** Originally, the bell tower code was written in assembly language and there was a chip on the board labelled 'Ayer' (Spanish for 'Yesterday') that held a rendition of The Beatles song. Unfortunately, this was the only song available for playback.



**02** A Raspberry Pi Zero, two IO Pi Zero expansion boards (each with an MCP23017 GPIO expander), and the bells' pre-existing driver module were connected together. Luckily, the power driver board and the flat cables could remain untouched and be reused. The pinout could be easily adapted to the IO Pi Zero boards by just soldering right-angled headers to them.

```

1 testPulseCompleted
2 port pulseForMilliseconds: 5.
3 out reset.
4 self
5
6   assert: out next equals: 16r12;
7   assert: out next equals: 2;
8   assert: out atEnd.
9   (Delay forMilliseconds: 7) wait.
10  out reset.
11  self
12
13   assert: out next equals: 16r12;
14   assert: out next equals: 2;
15   assert: out next equals: 16r12;
16   assert: out next equals: 0;
17   assert: out atEnd.
18

```

**03** Now with the new hardware and software, you can play any MIDI file on Raspberry Pi and the notes of the song will be mapped to the tuned bells. The code to control the chimes (along with more detailed instructions) can be found [magpi.cc/carrillon](http://magpi.cc/carrillon).

# Bellagio Water Show

This miniature fountain features water jets synchronised to music. **Phil King** dives in



**Nick Rogness**

Nick works in the telecom industry, but his true passion is spending time with his family and taking on challenging projects as an avid maker.

[magpi.cc/bellagio](http://magpi.cc/bellagio)

**W**hen his employer wanted a Las Vegas-themed float for the local parade, Nick Rogness was approached by the team for engineering assistance. “The decision to recreate the Bellagio water show started out as many good ideas start... a joke during a brainstorming session!” he recalls. “I knew it was technically possible in principle but would require overcoming some challenging engineering hurdles.”

Nick had just 30 days to come up with a technical solution to recreate the water show. “In reality, it ended up taking two weekends of assembling the hardware and two weekends of writing the software,” he says.

## Pump it up

A pump pushes water from a reservoir (children’s paddling pool) through PVC piping attached to water solenoids connected to sprinkler tubing pointed up in the air. A Raspberry Pi controls the solenoids, creating the effect of water jetting out in sync with the music being played.

“A total of eight solenoids were connected back to a mechanical relay, which in turn was controlled by Raspberry Pi,” says Nick. Seven out of the eight solenoids were connected to brass reducers to fit into garden sprinkler tubing. The eighth solenoid was a pressure control (relief) valve, which was used to control back pressure in the system.

“When I wanted to ‘fire’ one of the seven solenoids to shoot water, Raspberry Pi would close the pressure solenoid,” explains Nick. This built up pressure in the PVC pipe, at which time Raspberry Pi would trigger a relay to open the desired solenoid so a jet of water would shoot out. “This was required to get any distance with very little water. I also didn’t want to burn out the pump, so the relief valve was open when no other solenoid was open.”

## Water music

The music is synchronised to the solenoid firing by using FFT (fast Fourier transform) analysis performed on the audio in real-time. “I wrote a sequencer in Python to perform the analysis and determine which solenoids to turn on and off, based on a config file

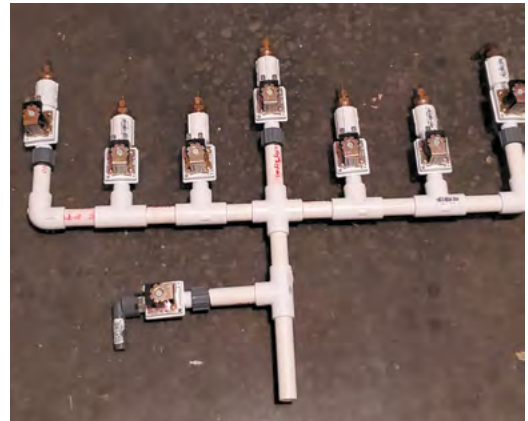

▲ Attached to half-inch PVC piping, each 12V DC water solenoid is connected back to the control board by way of a mechanical relay, operated by Raspberry Pi

which maps high fidelity signals (bass, mid-range, etc.) to particular solenoids or solenoid groups,” says Nick. “In summary, you just put WAV files in a songs directory and start the Python code, which did all the heavy lifting in real-time.”

One technical challenge was solving the timing discrepancy between the solenoid firing water and the musical note being heard by the audience. “The water had to be shot out of the jets approximately 600 ms ahead of the audio for the water to appear to be in sync with the music.”

Another issue was safety, as mixing water and electricity can be hazardous. “The power for the system was a 12 V automotive battery,” reveals Nick, “so I used fuses to protect things, just as you would find in a family vehicle. I also tried to keep the dangerous gear out of reach of the general public.”

Everything went well on the day, albeit with a few bugs: “There were certain sequences of musical notes where the FFT analysis would produce changes too rapidly for the back pressure and corresponding solenoid firing to produce much of a water jetting effect.” The result was a variance in water height from song to song.

“I rode on the float during the parade, so the public reaction was the most rewarding part of the project for me,” he adds. “After people figured out what they were looking at, the responses ranged from laughter to astonishment. The public response made my day and all the efforts of the team worthwhile!”



## Warning! Electricity & water

Take extra care when combining electricity and water in a project: the two should be kept well apart!

[magpi.cc/electricalsafety](http://magpi.cc/electricalsafety)







▲ A side view of the finished project on the back of the float, ready to join the parade

“ Eight solenoids were connected back to a mechanical relay, which in turn was controlled by Raspberry Pi ”



Water is pumped from a children's pool through PVC piping attached to water solenoids to turn the individual jets on and off

Protected by a case, a Raspberry Pi 3 runs the software, including real-time music analysis and controlling the water jets

Quick FACTS

- ▶ A single solenoid water jet could shoot well over 8m
- ▶ The water used is in a closed system
- ▶ Software is available on GitHub: [magpi.cc/ghbws](https://github.com/magpi/cc/ghbws)
- ▶ He'd never worked with water in an electronics project
- ▶ Future projects include a security drone and snow-removing robot



▲ A waterproof fuse box is used to safely distribute power from a 12V car battery

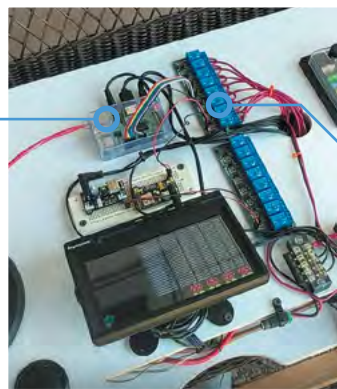

Nine relays are used: one to control the water pump, and the others to open and close the solenoid valves

# Raspberry Pine

Think all computers are boring black boxes? You've not seen Raspberry Pine, the desktop computer with a bit of class. **PJ Evans** gets all fancy



**Neil Shepherd**

Neil has been working with computers since the 1970s. Upon retiring, he joined U3A (University of the Third Age). Their electronics group rekindled his interest in Raspberry Pi.

**T**o many, a broken laptop would be a source of annoyance and hassle, but not Neil Shepherd, who saw nothing but opportunity. After a brief respite at the bottom of his wardrobe, Neil dismantled the laptop looking for useful spares and maybe some inspiration. He hit upon the idea of building a desktop computer that would fit in with the surrounding furniture, rather than being yet another drab black box. “What do you do with a 17-inch LCD panel? Put a frame round it,” he says. “It’s got to be different, so wooden... pine to be precise. Add a Raspberry Pi 3B+ and my love of awful puns gives us Raspberry Pine.”

## Wood-n’t it be nice

The screen is mounted in a custom pine frame and stand. The frame is built using strips of small pine architrave backed by pine strips, offset to give a suitable rebate for the panel to fit and hiding the border. The side supports are modified pine staircase spindles. A Perspex sheet is used to mount the electronics and, when powered, the panel backlight creates a warm glow. Finally, short lengths of foam draft excluder secure the panel sandwiched in the frame.

The LCD panel has a driver board with HDMI, DVI, and VGA inputs. This is connected to the project’s Raspberry Pi 3B+ by a short HDMI lead, with left- and right-handed adapters. This caused a headache for Neil: “I think the biggest challenge was sourcing the

LCD panel driver board from a UK supplier on eBay. Unfortunately, the only documentation you get is from the tiny screen printing on the board itself.”

The rest of the electronics supply and manage power. The main supply is the original PSU brick from the donor laptop, providing 19.5V at 4.5A. Two DFRobot PSU boards are used to drop the 19.5V to 5V for Raspberry Pi, and 12V for the LCD driver board, enough to power the backlight.

There is also the option of battery power, from three Li-ion cells recovered from another laptop. A battery management system (BMS) board sits on top of it and ensures the cell charge states are balanced. Finally, a charger board provides the correct constant current and voltage charge profile.

“What do you do with a 17-inch LCD panel? Put a frame round it. It’s got to be different, so wooden... pine to be precise”

## A tree-mendous result

The result is a very different take on the classic desktop project: a computer that would look just as at home on the bedroom dressing table as it would in the study. Neil was certainly pleased with the results, as well as an unplanned effect: “The choice of raspberry-coloured Perspex as the support for the electronics produced a pleasant surprise. When powered on, the LCD backlight gives a raspberry glow.”

Regarding planned further refinements, he tells us: “When the Raspberry Pi 4B+ gets the update to boot from USB, there may be a rebuild to refine the layout so the SSD doesn’t stick out the side. Currently, the donor laptop keyboard is being developed with an Arduino Due and more pine. There are thoughts of matching mouse and speakers.”

▼ The rear is an exposed collection of controller board and, of course, the project’s Raspberry Pi 3B+

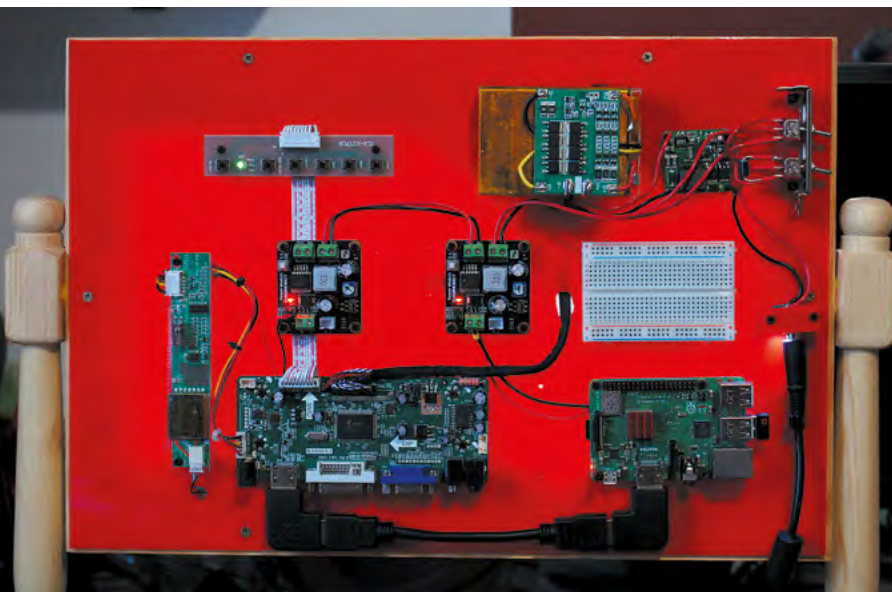



A salvaged 17-inch LCD screen from a dead laptop

A real pine frame constructed from standard parts normally used for skirting and staircases

Currently a standard wireless keyboard is used, but a pine keyboard is in the works!

### Quick FACTS

- ▶ The screen is a 2007 HP 17 laptop panel
- ▶ The computer will soon be joined by a pine-encased keyboard
- ▶ You can run the computer from the mains or battery
- ▶ The pine used is off-the-shelf, with small modifications
- ▶ Neil's next project is to record the animal that keeps pooing in his garden!

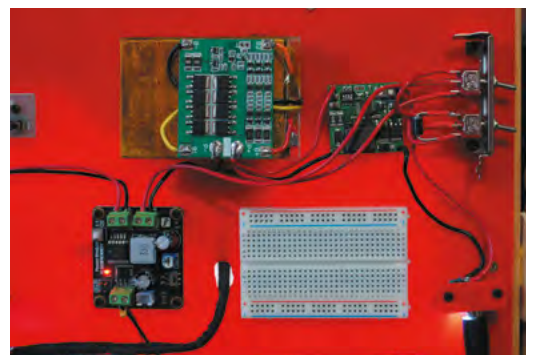
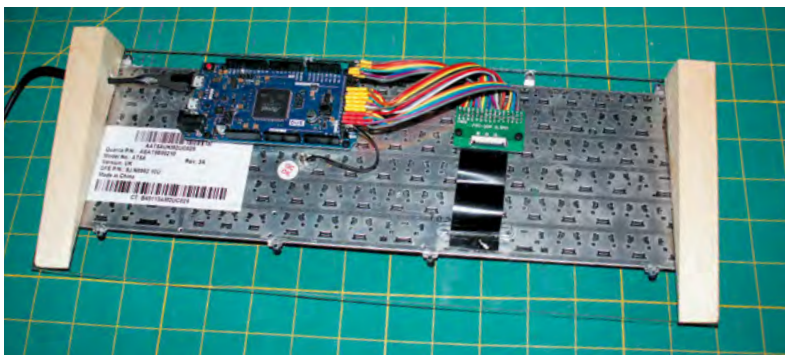

- ▲ Neil has thoughtfully added a breadboard and control switches for ease of use
- ◀ A matching keyboard, also from the laptop, is a work-in-progress

# Instaclock

Designed to celebrate a new home, Instaclock uses two Raspberry Pi computers to great visual effect. **Rosie Hattersley** finds out more



**Riccardo Cereser**

Riccardo is a UX designer for logistics company DFDS. After growing up in Italy and Dublin, he moved to Copenhagen to study interactive design. He's a keen illustrator and Raspberry Pi retro gamer.

@ricently

**T**here's nothing like a deadline to focus the mind! Copenhagen-based illustrator and UX designer Riccardo Cereser was about to move into a new apartment with his girlfriend, and was determined his new home would have a unique timepiece. Instaclock ([magpi.cc/instaclock](http://magpi.cc/instaclock)) is the result.

Having studied at the Copenhagen Institute of Interactive Design, Italian-born Riccardo was keen that his new apartment would include an object that reflected his skills. He began sketching out ideas in Photoshop, starting with the idea of images representing numbers. "A hand showing fingers; a bicycle wheel resembling the number 0; candles on a cake; or the countdown numbers that appear in the beginning of a recording..." he suggests.

Having decided the idea could be used for an interactive clock, he quickly worked out how such an image-based concept might work displaying the hour, minutes, and seconds on displays in three wooden boxes.

Next, he set off around Copenhagen. "I started taking photos of anything that could resemble a number, aiming to create sets of ten pictures each based on a specific theme," he recalls. "I then thought how awesome it would be to be able to switch the theme and create new sets on the go, potentially by using Instagram."



Instaclock displays fun images of numbers, rather than being a standard timepiece

This, Riccardo explains, is how the project became known as Instaclock. He was able to visualise his plan using Photoshop and made a prototype for his idea. It was clear that there was no need to display seconds, for example. Minute-by-minute updates would be fine.

“ I started taking photos of anything that could resemble a number ”

## Getting animated

Next up was figuring out how to call up and refresh the images displayed. Riccardo had some experience of using Raspberry Pi, and had even

Ikea file organisers make ideal frames to hold the displays



Pressing the button switches the image set used to display the numbers on that screen

### Quick FACTS

- ▶ Digital sketching tools were invaluable for planning this project
  - ▶ Many of the items used to build Instaclock came from Ikea
  - ▶ Riccardo got Instaclock's 'off switch' code from *The MagPi*
  - ▶ He is thinking of adding an alarm function next
  - ▶ He's pondering an animated weather cartoon version, too
- ◀ Stills from cartoons and illustrations work really well as a visual device and add to Instaclock's quirky appeal



## Build a cool clock

Each of the Instaclock's twin screens has a Raspberry Pi 3 Model B controlling image delivery to it. You'll need to adapt or build a box to house each screen, and drill holes to accommodate cables and ventilate it.

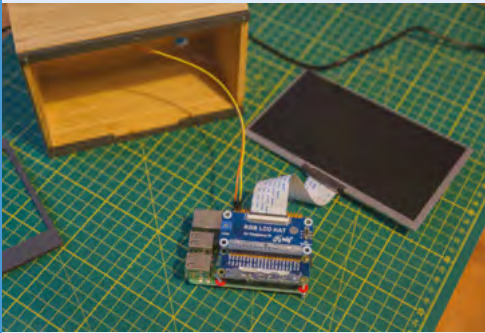

**01** Attach the LCD HAT's ribbon cable to the screen's input port. You might also want to use magnets to help secure the screen in place in its display box. Make sure all the screens are grounded!

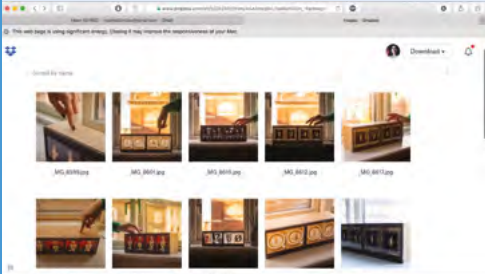

**02** Install Raspberry Pi OS on 8GB microSD cards, boot up, and connect each Raspberry Pi to your wireless network. Set a script to sync folders via Dropbox and use the cron scheduler to change the displayed image every two minutes.



**03** Set the Processing sketch to launch at startup (see [magpi.cc/process](https://magpi.cc/process)). Disable the screensaver (so it doesn't interrupt the clock script) and hide the cursor. Back up the microSD card, then switch on. Repeat steps for the other Raspberry Pi.



▲ Graphics from classic games may be used to tell the time – can you work it out?

made a RetroPie games console. He also had a friend on the interactive design course who might just be able to help...

Creative coder Andreas Refsgaard ([andreasrefsgaard.dk](https://andreasrefsgaard.dk)) soon got involved, and was quickly able to come up with a Processing sketch for Instaclock ([magpi.cc/instaclockgit](https://magpi.cc/instaclockgit)).

“ They also added a rule that shuts a screen down if the button on top of it is pressed for ten seconds or more ”

Having spent dozens of hours looking into how an API might be used to pull in specific images for his clock, Riccardo was grateful that Andreas immediately grasped how it could be done. Riccardo then set parameters in cron for each Raspberry Pi used, so the Instaclock loaded images at startup and moved on to the next image set every ten seconds.

Because Riccardo wanted Instaclock to be as user-friendly as possible, they also added a rule that shuts

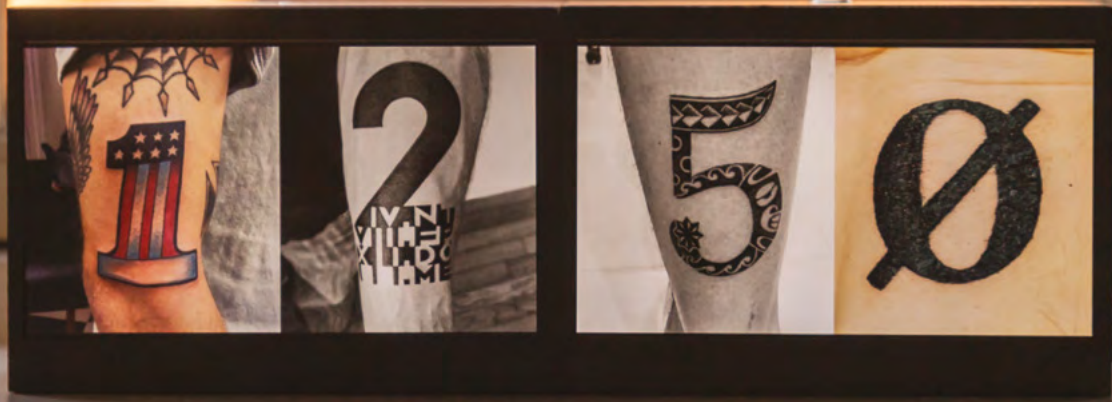

▲ Photographing distinctive details was part of the appeal of the project

a screen down if the button on top of it is pressed for ten seconds or more. The script was one he got from *The MagPi* ([magpi.cc/offswitch](http://magpi.cc/offswitch)).

### Assembly time

One of the most fun aspects of this project was the opportunity to photograph, draw, or source online images that represent numerals. It was also the most time-consuming, of course. Images reside in Dropbox folders, so can be accessed from anywhere. Deciding on a suitable set of screens to display them, and boxes or frames for them, could also have dragged on but for an impromptu visit to Ikea. Riccardo fortuitously found that the Waveshare screens he'd selected would fit neatly into the store's Dragan file organiser boxes. He was then able to laser-cut protective overlays secured with tiny magnets. [\[M\]](#)



▲ Visitors to Riccardo's apartment have been intrigued and challenged by the displays, which even feature the occasional maths problem

# CNC Etch-A-Sketch

Engineer Quint Crispin has been drawing lots of attention to his latest project, as **David Crookes** discovers



**Quint Crispin**

Quint is an engineer who loves to play around with cool builds. He created his Etch-A-Sketch project with the help of his young son, who assisted with its fine-tuning.

[magpi.cc/cncetch](http://magpi.cc/cncetch)

▼ The project is powered by four lithium cells in conjunction with a battery management system to give five hours of operation

For 60 years, the iconic Etch-A-Sketch toy, invented by French electrician André Cassagnes, has provided a blank canvas that has both enthralled and infuriated. Many of us will go no further than drawing some simple straight lines and shapes. But there are some amazing practitioners out there (check out Jane Labowitch and Dave Roberts) who can generate incredible works of art.

Quint Crispin admits he is not one of them, but, with a bit of ingenuity, the engineer has nevertheless found a way to unleash his creativity. He has devised a machine to perform the magic for him, using a Raspberry Pi 3 computer connected to a CNC HAT made by Protoneer. This has enabled two NEMA-17 size stepper motors to be controlled – hooked, as they are, to the Etch-A-Sketch’s two knobs using a belt attached around blue timing pulleys.

## Shaking things up

“I had no idea the Raspberry Pi was so powerful,” he says. “But when I discovered it was capable of driving stepper motors using programs such as



▲ For the creation of stop-motion videos, the camera sits behind black fabric to prevent reflections, and each image is drawn 1 to 2mm apart for smooth footage

bcNC, I knew I’d found my solution for a portable CNC Etch-A-Sketch.” Indeed, his use of our favourite computer meant he could produce a wireless unit that was so light and sturdy, it could also be picked up and shaken to clear the display without causing any damage.

“Other projects have connected stepper motors to an Etch-A-Sketch, but the makers have quickly found they have to take the whole thing apart just to reset the screen,” Quint tells us. “That’s something I’ve never had to worry about because I spent a lot of time designing and producing a strong frame. It meant more work up front, but was well worth it in the long run.”

Even so, the challenge didn’t stop there. As with all CNC machines (those which use software connected to a tool to automate control such as 3D printers), simple x and y co-ordinate commands are issued. “You’re basically telling the machine ‘go here, go there, now here, now there’ using commands known as G-code,” Quint explains. Coding is, therefore, crucial.

## Turning things around

For this, Quint used variations of the G-code command G1, noting the required x/y position and the required speed. “As an example, G1 X40 Y60

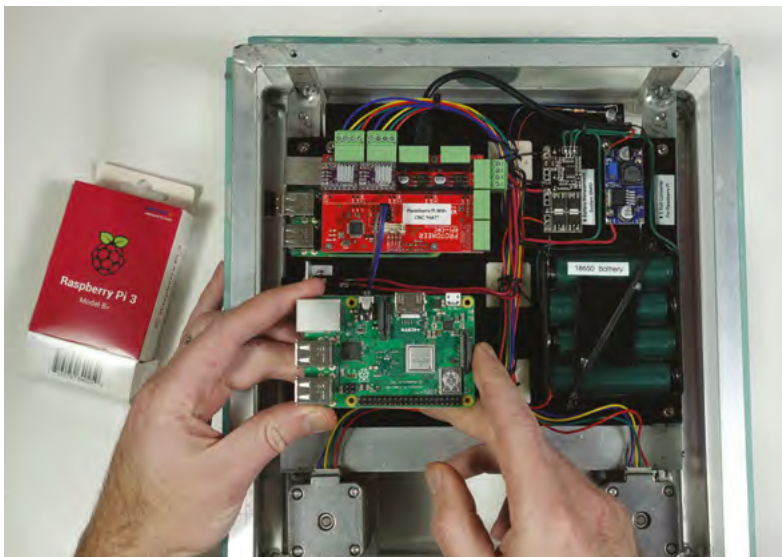



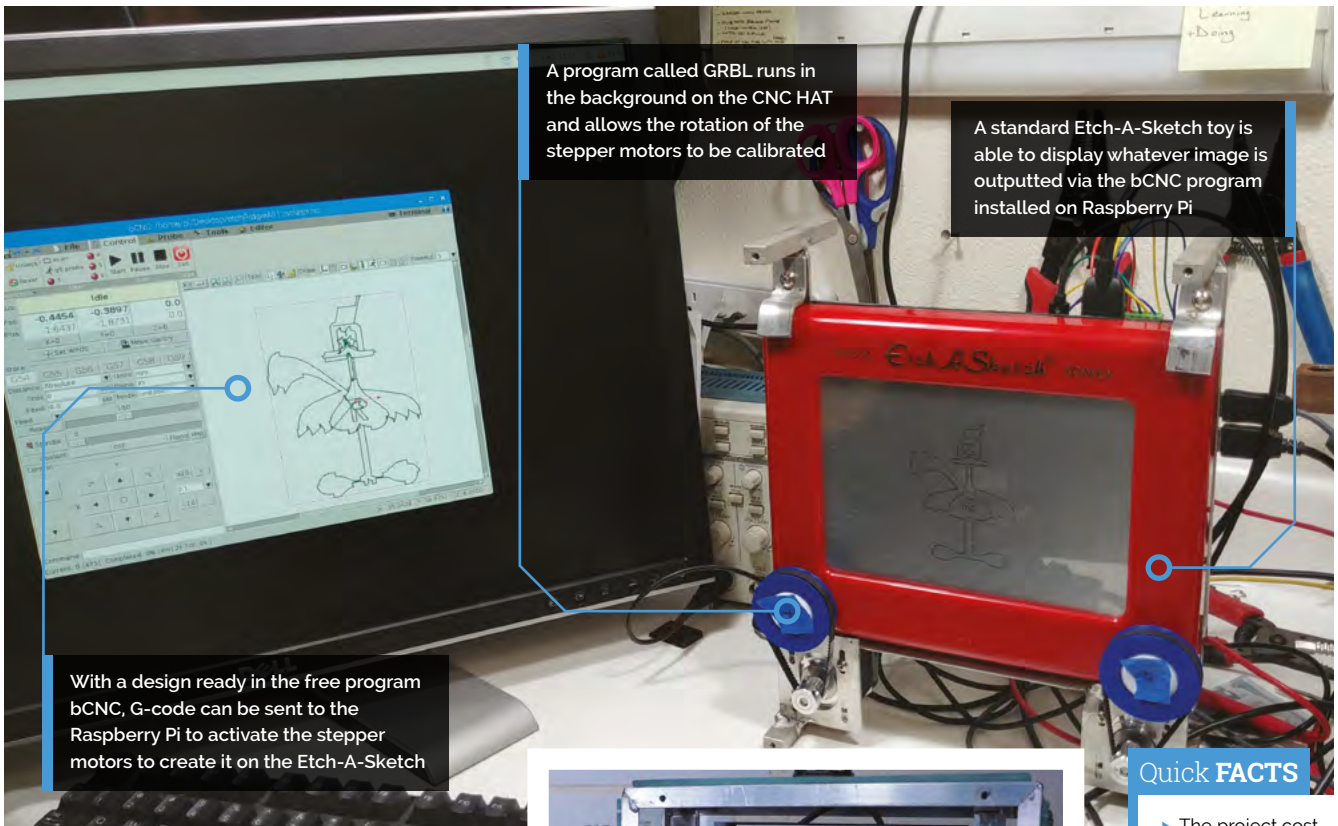

A program called GRBL runs in the background on the CNC HAT and allows the rotation of the stepper motors to be calibrated

A standard Etch-A-Sketch toy is able to display whatever image is outputted via the bCNC program installed on Raspberry Pi

With a design ready in the free program bCNC, G-code can be sent to the Raspberry Pi to activate the stepper motors to create it on the Etch-A-Sketch

**Quick FACTS**

- ▶ The project cost less than \$200
- ▶ It uses 3D printer stepper motors
- ▶ The frame is light enough to shake
- ▶ Raspberry Pi is running bCNC
- ▶ It also wears a CNC HAT

“ Using small enough line segments, you can even draw a circle! ”

F400 means go 40 mm to the right and 60 mm up at a speed of 400 mm per minute,” he says. “Using small enough line segments, you can even draw a circle!”

The first real problem he encountered was the looseness in the Etch-A-Sketch mechanism when changing directions. “You have to turn the wheels further than you think – if you mark an Etch-A-Sketch dial and bring it to the same spot from both directions, you’ll get about a 1.5mm mismatch which can make your sketches look really poor. Most CNC software has ‘backlash compensation’ to account for this, but bCNC does not. Fortunately, I stumbled on a free program called NoLash that adds backlash compensation to the G-code program itself. You just tell it how much to compensate for and it does the job for you.”

Now, by firing up bCNC, Quint can create an image and have it replicated on the Etch-A-



▲ For fun, Quint decided to play around with stop-motion video. He’d create an image, take a photo of the Etch-A-Sketch screen, shake, and create another image

Sketch screen with the knobs being automatically manipulated. It has also allowed for some very elaborate designs, which have impressed all who have seen them being created. “Once I got it figured out, everything worked really well,” he says. “The experience has been magical.”

# Solar-powered Raspberry Pi Camera

Kaspars Dambis has put an eye in the sky using his Raspberry Pi, as **David Crookes** explains



**Kaspars Dambis**

Kaspars is a web developer and electronics enthusiast who enjoys creating simple, low-power connecting projects that use microcontrollers.

[kaspars.net](http://kaspars.net)

**B**uilding a new family home from scratch is not for the faint-hearted. Neither, on reflection, is climbing up a tree to install a solar panel and a CCTV camera, and yet Kaspars Dambis has done both.

One thing led to another. “I wanted to monitor the construction site remotely because we currently live 100 kilometres away,” he says. But rather than buy an off-the-shelf CCTV system, he purchased a dummy camera case, creating his own way of capturing images using a Raspberry Pi 3 Model B computer.

“From the start, I wanted to keep watch over the building of our home and create a time-lapse of the process for fun,” explains Kaspars. “I knew it had to be a battery-powered and wireless system because getting mains power to the device wasn’t going to be possible on a site like that.”

## Seeing the light

Kaspars picked up a lightweight 18V 5A solar panel that was marketed as being perfect for charging

boats and cars. This, he figured, would gather energy from the sun to charge a 12V battery and, with the use of an inexpensive 12V-to-5V buck module, power the Raspberry Pi 3 Model B and an eight-megapixel Raspberry Pi Camera Module v2.

At first, Kaspars attempted to build a case from a generic project box, but he found it was relatively difficult to find decent clear glass for the camera window. “I then noticed a dummy security camera in a local hardware store which had perfect clear glass on one end, and full weather projection for the battery-powered LED system,” he says. And this worked a treat.

“The weather protection proved to be great, even during the winter months”

Using hook-and-loop fasteners, the Camera Module could be attached to Raspberry Pi’s case which, in turn, was secured to the inner housing of the camera casing. “The weather protection proved to be great, even during the winter months, and [my] Raspberry Pi never had issues with the temperature ranges either.”

To get as much energy as possible, the solar panel and the 12V battery were positioned up high on a wooden frame, with the security camera device attached too. This wasn’t ideal. “The battery was heavy and the frame broke during a storm, so I created two separate frames: one for the solar panel with the camera unit below and another for the battery and the solar charge controller,” he says.

## Monitoring from afar

Kaspars configured his Raspberry Pi to connect to a nearby WiFi access point via a standalone



▲ Fitting the system in a tree prevents tampering and makes the setup look less intrusive



**Alert!**  
Batteries  
included

Please take care with rechargeable car batteries:  
[magpi.cc/carbat](http://magpi.cc/carbat)



▲ A 12V, 7Ah lead-acid battery has been sufficient to provide an average power consumption of 2W since it can provide 84 watt-hours of energy

modem plugged in at his neighbour's house by setting the access credentials in the **wpa\_supplicant.conf** file in the root of the SD card. "The most basic time-lapse functionality was added using a simple Bash script which takes a picture from the raspistill tool at the desired time intervals and stores it on the SD card."

Connecting remotely involved setting up an external server and using the SSH tunnel, autossh. When up and running, a photo is taken every hour and it can be downloaded using SCP when connected to the same WiFi access point as Raspberry Pi. Video capture and real-time feeds can also be viewed in a browser.

It all means Kaspars is now able to remotely log in to his Raspberry Pi and eventually see his new home come into being. There is still an element of fear, though. "The ability to connect to a Raspberry Pi which is up in a tree powered by the sun and 100 km away is a special feeling," he says. "Every command you type in the terminal has the potential to break the WiFi connection – and the cost of each mistake is a 200 km drive to restart the device." 

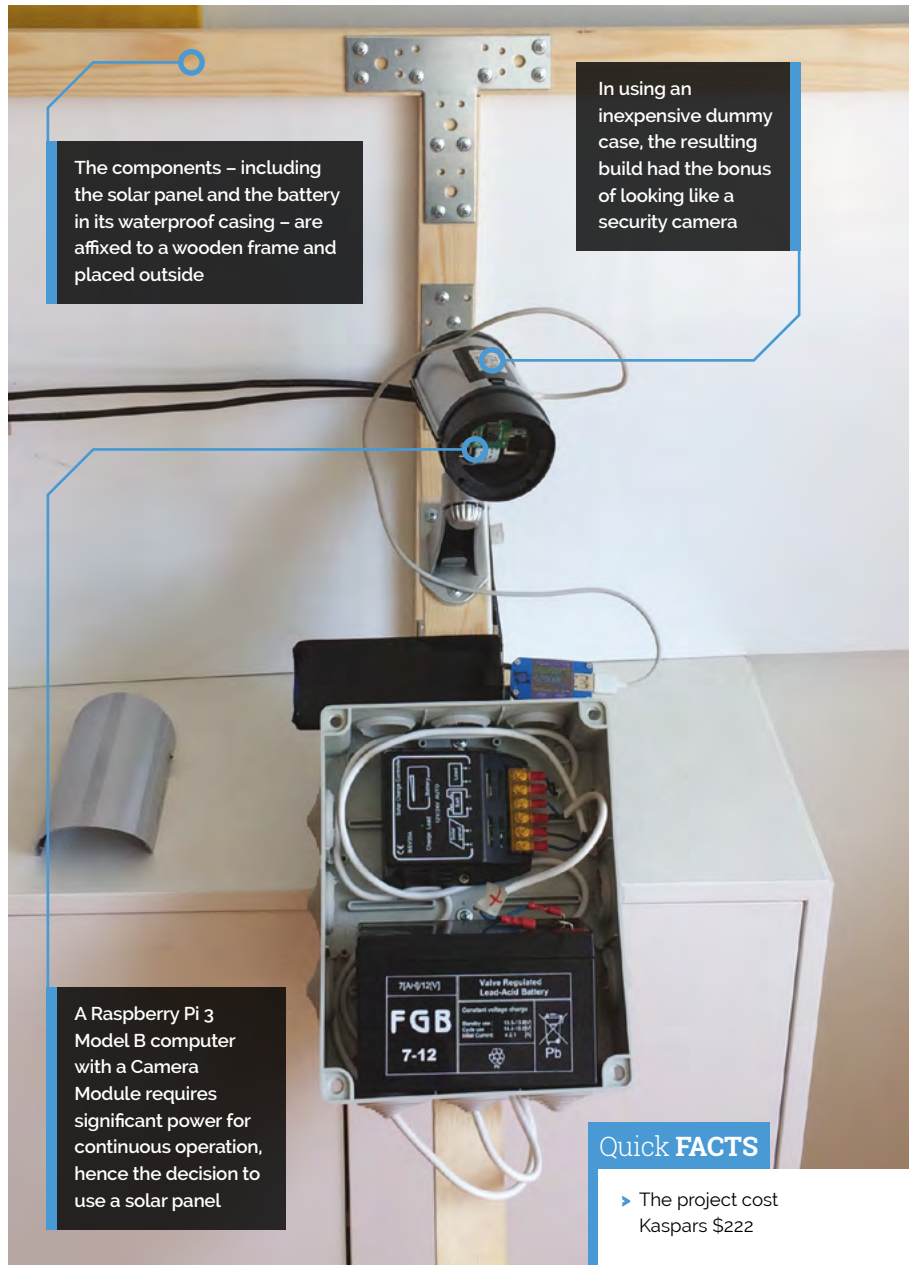

The components – including the solar panel and the battery in its waterproof casing – are affixed to a wooden frame and placed outside

In using an inexpensive dummy case, the resulting build had the bonus of looking like a security camera

A Raspberry Pi 3 Model B computer with a Camera Module requires significant power for continuous operation, hence the decision to use a solar panel

**Quick FACTS**

- ▶ The project cost Kaspars \$222
- ▶ He's also paying for 10GB of monthly data
- ▶ It should run for two days without charging
- ▶ Getting it up a tree was the hardest part
- ▶ All cases need to be waterproof



▲ Dummy security cameras can be picked up cheaply – this one cost Kaspars just \$8

# Flying Saucer Clock and NAS

If you're thinking of fashioning yourself a new clock, have you considered one with an extraterrestrial twist? **Nicola King** has a close encounter...



**Harry Tansey**

MAKER

A software engineer, DIYer, and maker, with interests in music visualisation, XR, 3D design and printing, Raspberry Pi, microcontrollers, electronics, and blinky LEDs.

[planetzarg.com](http://planetzarg.com)

**U**K-based Harry Tansey is a maker who'd been considering creating some form of clock project for a while, when he was inspired to make something that did more than just tell the time. "I have been experimenting with WS2812B LEDs (aka NeoPixels) over the past few years and knew they were going to be a key component," he says. "When my NAS (network-attached storage) box started playing up last year, I knew I had to make or buy a replacement. Given that both a NAS and a clock tend to be on 24/7, I started toying with the idea of ring of 60 LEDs as clock segments and arranging the NAS components (Raspberry Pi, HDDs, and PSU) inside."

## Print perfect

So, the concept for the Flying Saucer Clock was born, and Harry set about designing a prototype using Fusion 360. Given that he was going to 3D-print the clock, he knew it was critical to get the design as precise as possible, in order to save



▲ A side view of the saucer. Transparent segments are used to diffuse the LEDs, with light blockers between them for crisp separation

both time and money with expensive, failed 3D prints. "Failure can be expensive when the weight of filament in the project is just short of 2 kg! This equates to nearly 120 hours of printing time – or about four days using two 3D printers running simultaneously for around 14 hours a day," he calculates.

Harry also set himself another challenge: "It was critical to give the pieces enough tolerance so they could be used straight from the printer and fit together with minimal surface finishing."

Despite a few hiccups with his first attempt, Harry pushed on, and the finished article is something to behold. So, how is it constructed? "The outer ring has 60 RGB LED segments constructed simply by cutting a length of a standard WS2812B LED strip and mounted in a 3D-printed holder with protrusions to keep the LEDs fixed in place," he says. "Lighting one of outer LEDs red indicates the seconds, and a green one indicates the minutes. I found that lighting the two LEDs to either side of the minute LED improved the readability."

Harry also created an inner ring of LEDs divided into twelve segments, and one of these is lit in blue to indicate the hour. He then lit up some hour markers on twelve of the outer 60 LEDs, making it easier to track the positions of the minute and second LEDs. Harry chose a Raspberry

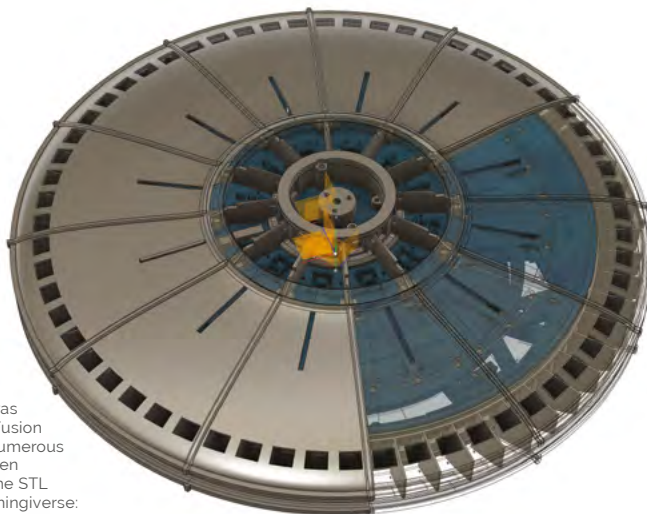

▶ The saucer was designed in Fusion 360 and its numerous parts were then 3D-printed; the STL files are on Thingiverse: [magpi.cc/flyingsaucerstl](https://magpi.cc/flyingsaucerstl)

Transparent levers attached to push-buttons can be pressed to switch between different lighting effects

The LEDs act as a Tix-style clock: red to show seconds, green for minutes, and light blue for the hour

The body panels and LED diffusers were 3D-printed and then assembled

**Quick FACTS**

- ▶ The Flying Saucer is 400 mm in diameter
- ▶ It's lit up by a total of 84 NeoPixels
- ▶ The twelve body panels were printed in vertical orientation
- ▶ See how Harry made it here: [magpi.cc/flyingsaucernas](http://magpi.cc/flyingsaucernas)
- ▶ Harry has around twelve Raspberry Pi boards around the house, including one controlling his central heating
- ◀ The two NAS disk drives and Raspberry Pi are housed within the saucer, powered by a 12V PSU via three buck converters

Pi 4 to drive the LEDs as he was “really excited by the capabilities of [its] full-speed Ethernet and USB 3 ports.”

The Flying Saucer’s NAS file-sharing functionality comes by way of two 3.5-inch drives, secreted inside, and a fairly simple Samba setup. “I have created different file share areas for work, family members, and storage for my Linux-based satellite TV/PVR receiver,” reveals Harry.

**Udderly ingenious!**

Harry says that the feedback from family and friends has been very positive, but, he’s not finished there with his flying saucer. “There is another ring of twelve RGB LEDs on the bottom of the UFO. These all face inwards and the final effect runs these in a slow pulsating pattern. With a semi-transparent cup that I borrowed from my daughter, it makes a really convincing beam effect that appears to ‘travel’ down the cup as the light intensifies. I am going to use this together with a 3D model of a cow for the ‘traditional’ cow abduction effect.” [M](#)

“ Failure can be expensive when the weight of filament in the project is just short of 2 kg! ”



# Chamber: Sourdough Incubator

Having issues with your sourdough starter? Read on and be inspired... here's a radical baker using his loaf. **Nicola King** delves into the dough



**Trent Fehl**

MAKER

US-based Trent is a maker with electrical engineering training and a love for writing software. His personal projects are often inspired by his experiences outside of tech – most often cooking, hiking, and cycling.

[magpi.cc/chamber](http://magpi.cc/chamber)

**W**hen maker, and baker, Trent Fehl first started making sourdough bread, he realised that keeping the starter at the correct, steady temperature could be a bit of a minefield. “I read all about different techniques for keeping a culture alive – of the different conditions to monitor, temperature was chief,” he tells us. “Bakers have all sorts of tricks to achieve that temperature. Some have a spot on their kitchen counter-top they like, others prefer an oven (turned off) with the light on, but many recommend specialised proofing boxes. What struck me was that only one of these options allowed you to set the temperature and you could only control to temperatures higher than ambient.”

### All you knead to know

Trent decided to take on the challenge of designing a product to meet his culinary needs, and was sure that he wanted to incorporate a small Peltier cooler in his project, as his friend Scott Hutchinson



▲ The fruit of Trent's labours: a delicious sourdough loaf

had given him the idea on a camping trip. “He happened to be a spacecraft thermal systems engineer and suggested using the Peltier cooler for both cooling and heating,” says Trent. “I thought this was so slick that I really got moving on the project when I got home.”

So, how exactly does the incubator work? “The Chamber utilises a Peltier cooler, also known as a thermoelectric cooler, to either pump heat from inside the Chamber to the outside (cooling the interior) or to pump heat from outside the Chamber to the inside (heating the interior),” explains Trent. “The direction that the heat is pumped is simply controlled by alternating the polarity of the voltage applied to the Peltier cooler.”

He changes the temperature in the Chamber with an H-bridge module driven by a Raspberry Pi Zero. So, if the temperature gets too high, the fan on the outside wall pushes the heat away, and if too cold, another inside fan pulls warm air in. This being Trent's first Raspberry Pi project, he appears converted, saying the single-board computer “is

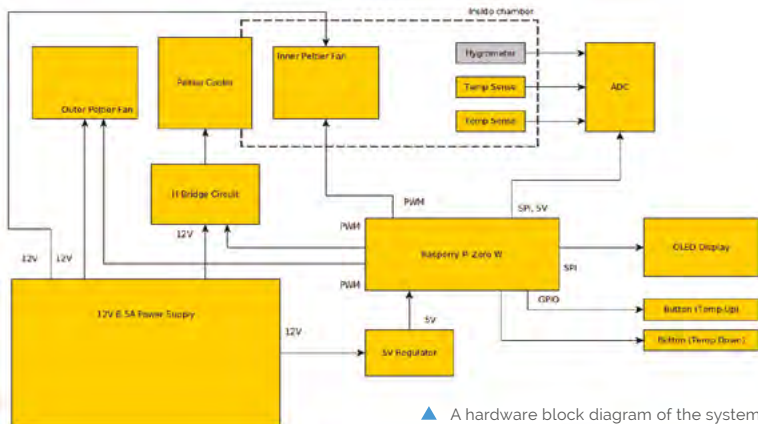

▲ A hardware block diagram of the system, showing how everything is connected

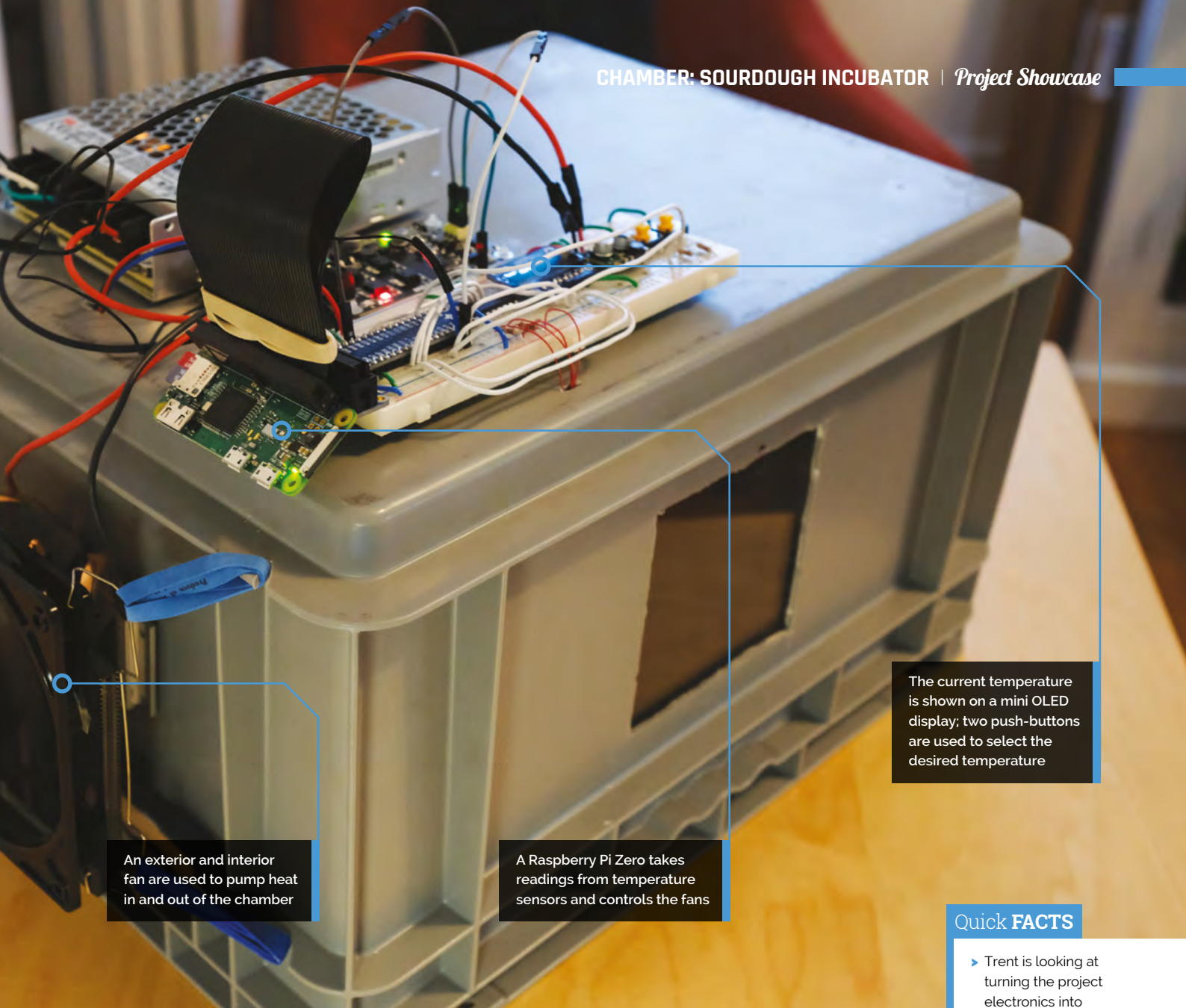

An exterior and interior fan are used to pump heat in and out of the chamber

A Raspberry Pi Zero takes readings from temperature sensors and controls the fans

The current temperature is shown on a mini OLED display; two push-buttons are used to select the desired temperature

### Quick FACTS

- ▶ Trent is looking at turning the project electronics into a HAT
- ▶ The Chamber can keep a steady temperature between 16 and 28°C
- ▶ The software for the project is written in C++
- ▶ See the GitHub page for code and details: [magpi.cc/chambergit](https://magpi.cc/chambergit)
- ▶ Trent is experimenting with machine learning projects using Raspberry Pi

just such a great tool for personal projects: there is an excellent community offering software libraries, lots of compatible hardware, and helpful guides.”

### You say sour, I say sauer

It’s true that bakers can buy proofing boxes, but Trent thinks that his incubator has clear advantages over commercially available alternatives. “The big advantage my chamber offers is heating and cooling in one package; plus it might be cheaper. Some of the off-the-shelf, heat-only options are almost \$200 new, while mine is ~\$180.” In addition, Trent’s invention can be used for other foodstuffs: “I enjoy baking, and I really enjoy eating bread, but I’d be lying if I didn’t say that the mad scientist aspect of harnessing the power of fungi and bacteria to create tasty foods didn’t draw me in... we’ve also fermented jars of garlic and jalapeños, sauerkraut,

“ I realised there were more people with this problem than I originally thought ”

and various peppers. I’m proud to report that everything has tasted good.”

Trent demonstrated his Chamber at the 2019 Hackaday Superconference, and got a brilliant response from like-minded makers. “Right at the start of my talk I said something like, ‘for those of you who maintain sourdough starters, you might be familiar with specific target temperatures but no means to control to those temperatures,’ and I noticed that a good number of people were smiling and nodding their heads. At that moment, I realised there were more people with this problem than I originally thought,” he says. [M](#)

# DropStitch

The joy of creating something wonderful – whether in code or another medium – can turn to despair without a means of rendering it. **Rosie Hattersley** applauds a new option



## Margaret Low

Margaret is director of outreach at the University of Warwick's Manufacturing Group, making extensive use of Scratch and CAD in her efforts to widen participation in computing and technology.

[magpi.cc/dropstitch](http://magpi.cc/dropstitch)

▼ TurtleStitch uses a familiar block-based interface, so you can boost your coding skills while focusing on being creative

**C**reative crafting is all the rage and can be a fulfilling and mindful hobby that combines easily with technology. A workshop using one example, TurtleStitch, at the summer 2019 Raspberry Pi-hosted Scratch Conference in Cambridge was packed. It's a popular visual means of using Snap! ([magpi.cc/snap](http://magpi.cc/snap)) and a great learning tool which will be made all the more usable thanks to the creation of DropStitch.

After being created in TurtleStitch ([turtlestitch.org](http://turtlestitch.org)), designs are printed using a digital embroidery machine, such as the one Margaret Low from the University of Warwick brought along to the Scratch Conference.

Getting the designs on to her embroidery machine involved transferring them from a PC or smartphone to the device on a USB stick – a rather clunky option that meant the user had to be in the same location as the embroidery machine, or send it to someone to initiate the embroidery on their behalf. Margaret points out that frequently switching USB sticks can result in wear and tear on the embroidery machine USB port.

After discussing these issues with other TurtleStitch demonstrators, Margaret came up with the DropStitch project in order to solve this problem. “It enables devices that normally read files from a USB drive to receive files wirelessly using Bluetooth file transfer (or WiFi) – so



▲ Margaret demonstrated the DropStitch system at the 2019 Scratch Conference in Cambridge

freeing them up from being tethered,” she says. DropStitch works with TurtleStitch and other embroidery programs (those supported largely depend on the embroidery machine being used).

“ The free stitch cards provided by TurtleStitch provide Snap! tutorials ”

## Inspiring creative coding

Margaret uses the industrial embroidery machine in the university's engineering faculty's workshop, demonstrating TurtleStitch and coding to students and visitors, and potentially broadening the appeal of an under-represented STEM subject.

Because Margaret also regularly holds classes introducing schoolchildren to code using TurtleStitch, she knows only too well the issue of having to contend with a succession of USB sticks so that kids could print their designs. It's a time-consuming drag! However, she enthuses about the software's role in broadening the appeal of coding. Coding can be done on a tablet and laptop. The free stitch cards provided by TurtleStitch

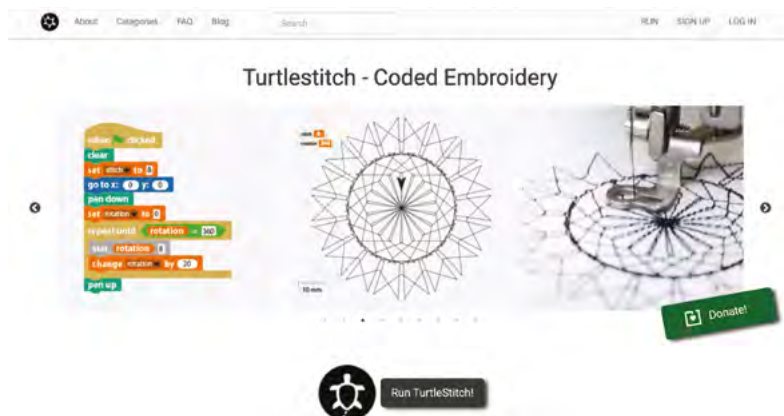





▲ TurtleStitch designs use Snap!, a block-based programming language, to create some incredible geometric designs

provide Snap! tutorials that result in impressive geometric designs and lettering, so you can quickly go from being a beginner to producing impressive embroidery.

If you don't have access to an embroidery machine, you can send your completed design to someone who does – something that DropStitch makes appreciably easier.

### Smart thinking

Margaret explains: “The aim was to avoid some of the problems with USB memory sticks such as having sufficient USB memory sticks for the class, identifying files to be stitched, and the accidental overwrites of files. DropStitch is based on *The MagPi* article [by Dave Honess in issue 60], ‘Make a Pi Zero W Smart USB flash drive’ ([magpi.cc/usbflash](http://magpi.cc/usbflash)). DropStitch has some modifications [from the original] because Raspberry Pi Zero W and the embroidery machine can't both write to the same USB partition at the same time.”

Essentially, it uses the embroidery machine's USB port to add either WiFi or Bluetooth connectivity and provides device discoverability and only needs a Raspberry Pi Zero W to do so. All the instructions to install and enable DropStitch are provided on the tool's webpages at [magpi.cc/dropstitch](http://magpi.cc/dropstitch).

Margaret is keen to help extend DropStitch's usefulness by making code available for others to customise: [magpi.cc/dropstitchcreate](http://magpi.cc/dropstitchcreate). There's even a form on the DropStitch homepage to request support for a particular embroidery program. [M](#)

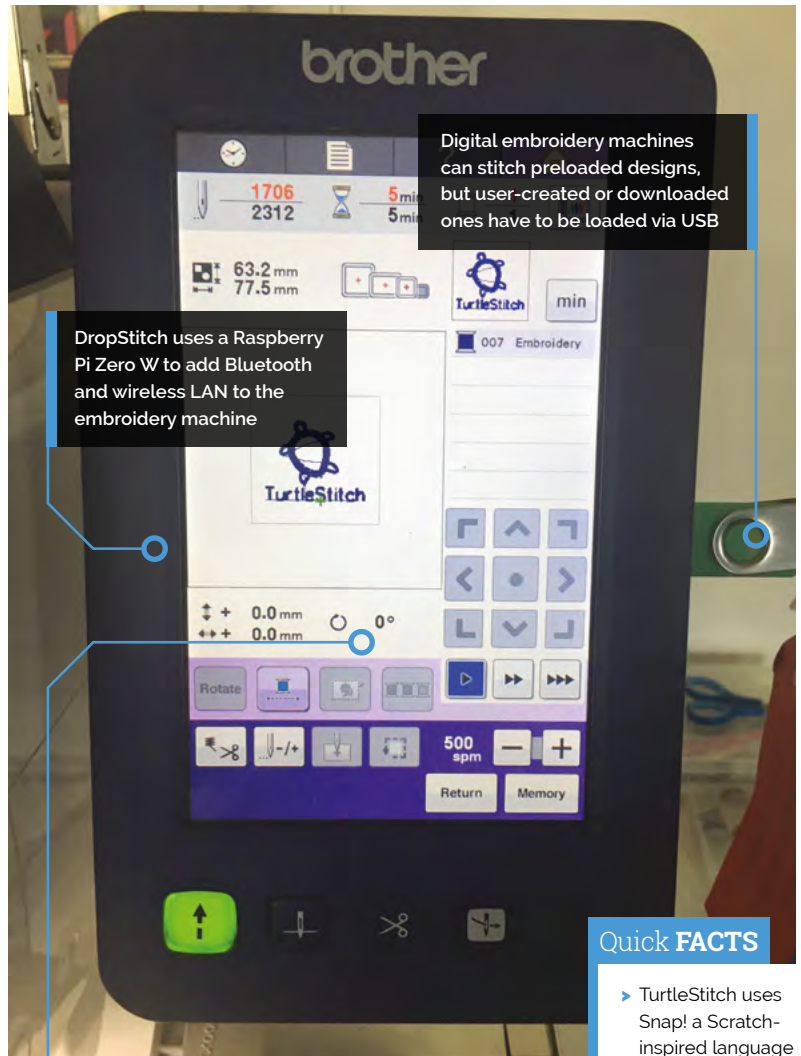

Once transferred to the embroidery machine, images to be stitched can be previewed and selected as usual from the touchscreen



▲ TurtleStitch designs created by Warwick University can be embroidered onto T-shirts or bags or used to make homewares. Image: Helen Luchhurst

### Quick FACTS

- ▶ TurtleStitch uses Snap! a Scratch-inspired language
- ▶ The impressive embroidery tool has an international following
- ▶ TurtleStitch sees Snap!'s pen as an embroidery needle
- ▶ Margaret uses Scratch in school outreach programmes
- ▶ Warwick University provides lots of free TurtleStitch tutorials: [magpi.cc/warwickTS](http://magpi.cc/warwickTS)

# RIoT Brick



**Alan Peaty**

MAKER

Cloud architecture engineer Alan enjoys IoT tinkering and inspiring his kids. He says: "Technology is here to stay. We should all get to learn about it."

[magpi.cc/rosieredrobot](http://magpi.cc/rosieredrobot)

Long-distance running and a love of intrepid devices led one creator to embark on a project demonstrating that 'true geekery and nature can co-exist'. **Rosie Hattersley** tries to keep up

**M**embers of his local running club are no longer fazed when ultra-runner Alan Peaty cruises past with an unidentified extra item or three attached to his person. While some fitness fans go for the ultra-sleek look to minimise air resistance and extra weight, Alan regularly takes the opposite approach and brings a little something extra along on his treks on the Cotswold Way.

Cloud computer engineer Alan regularly blogs about his Internet of Things inventions at [magpi.cc/rosieredrobot](http://magpi.cc/rosieredrobot) and has previously graced these pages with his Countdown-playing robot (see [magpi.cc/countdown](http://magpi.cc/countdown)). "Building intrepid devices I can take along with me outdoors is the perfect way for me to combine my interests in one fell swoop," he says. "I have been known to go running with 3D-printed devices attached to my legs (although understandably only at night) to gather data on my leg movement."



▲ The Brecon Beacons, where Alan tested his project to track his progress during a gruelling running race

In September 2019, Alan put his movement-sensing project to the test in a gruelling endurance race across the Brecon Beacons in Wales. He created the 'RIoT Brick' (Rosie Internet of Things Brick) so his family – some as far away as Australia – could remotely track his progress. Hooking himself up in this way also enabled Alan to monitor basic environmental conditions during what would be "a very, very long day!"

“ I have been known to go running with 3D-printed devices attached to my legs ”

## Sensitive subject

The RIoT Brick is a Raspberry Pi Zero-based sensing station housed in a crudely 3D-printed box. Alan cheerfully explains that he prefers to

▼ The RIoT Brick's live data feed

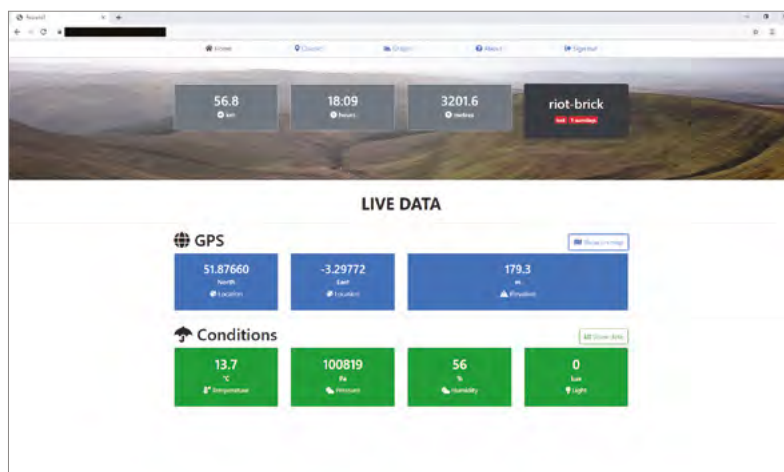

The RIOT Brick is encased in a 3D-printed shell to protect the Raspberry Pi Zero inside safe over the 58-mile trail

The rugged antenna helps the RIOT Brick communicate with other transceivers (maintaining a signal and internet connectivity proved tricky for this project)

The LCD can be used to provide GPS co-ordinates, but was switched off to preserve battery power during the 10 Peaks Challenge. Those following Alan's progress via the web still got detailed data!

**Quick FACTS**

- ▶ The RIOT Brick project cost less than £50 all-in
- ▶ Remote tracker data exchange was a particular challenge
- ▶ There was no way to check whether the transceiver was faulty
- ▶ It didn't matter because before the race began...
- ▶ ...the aerial broke off in Alan's car boot

◀ The rig securely attached to Alan's ultra-running backpack



## Create a RIoT

The RIoT Brick consists of a Raspberry Pi Zero, battery pack, transceiver and sensor modules, plus related AWS scripts. Three Python scripts manage incoming data and check for an active internet connection.



**01** Connect your Raspberry Pi Zero to an nRF24L01+ transceiver. This will receive the data from the other sensors. You also need a u-blox NEO-6 GPS receiver to obtain GPS readings.



**02** Temperature, pressure, humidity, and light readings are provided by BME280 and BH1750 sensors. Data from all the sensors and transceivers is stored locally in an SQLite database on Raspberry Pi Zero.

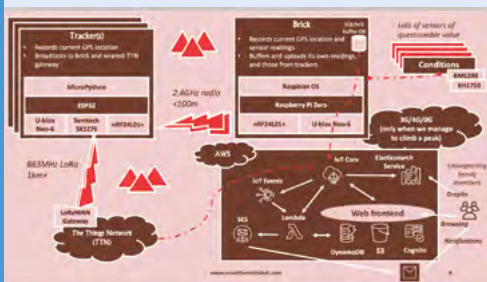

**03** This useful schematic shows the data flow and how to assemble the RIoT Brick. Full instructions are at [magpi.cc/riot10peaks](http://magpi.cc/riot10peaks).



adapt existing code and hardware, and tries to stay well away from designing and printing ‘stuff’ for his projects. In this instance, the Brick case was needed to protect the Raspberry Pi Zero and sensing modules from many miles of jostling on his 58-mile run across ten peaks.

The box houses a nRF24L01+ transceiver and u-blox NEO-6 GPS receiver, along with BME280 temperature/pressure/humidity and BH1750 light sensors. Alan credits the Raspberry Pi and Linux community for the ease with which he was able to get these devices up and running. “I chose a Raspberry Pi Zero as the central component as I needed a flexible Linux platform that was sufficiently powerful to run multiple applications concurrently,” he says.

The abundance of community-developed open-source libraries available for the modules and sensors he planned to connect to it was another big draw. He made use of an SQLite database and Python SDK Amazon Web Services. “IoT Core,

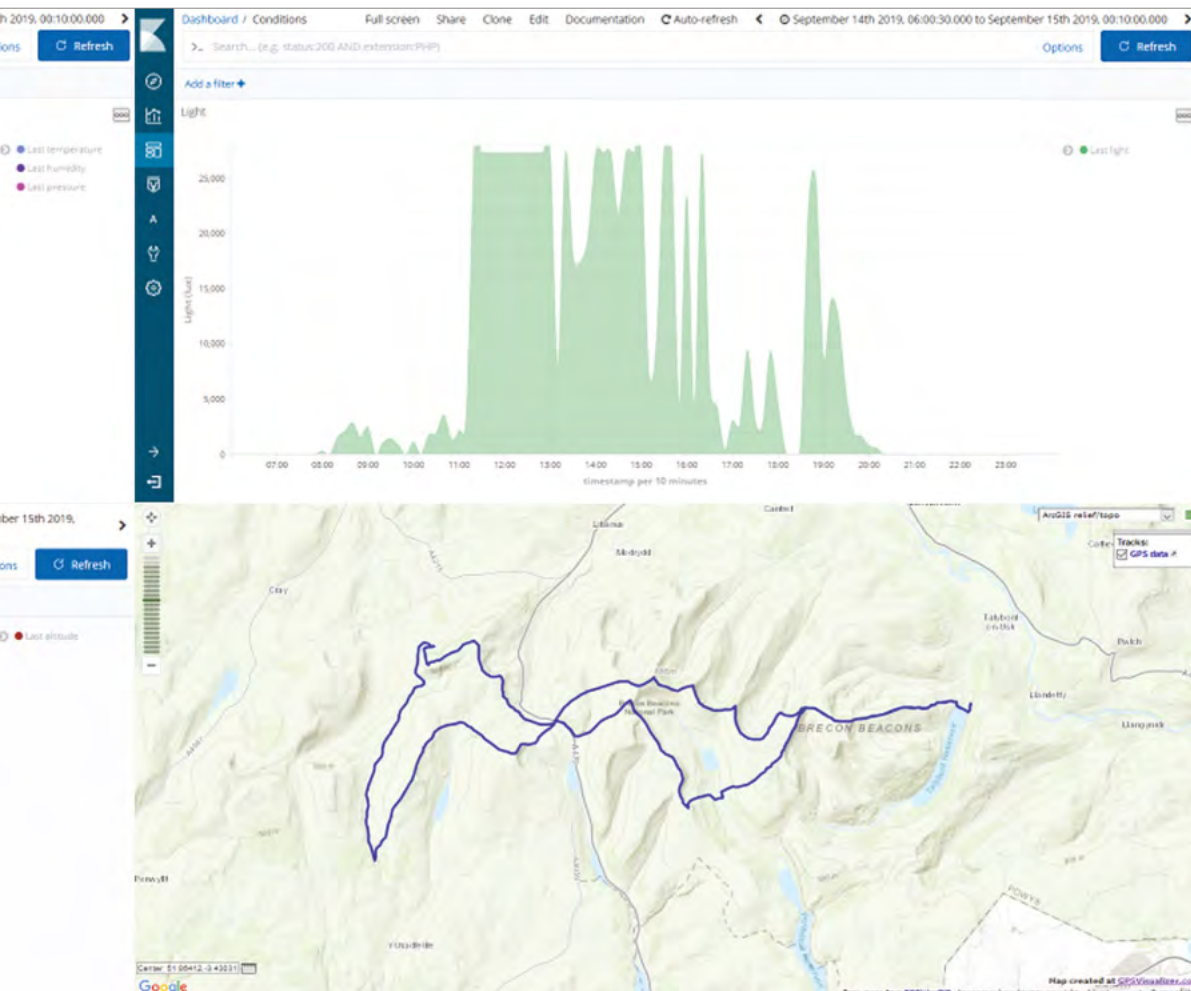

- ◀ Data from four sensors in the RIoT Brick captured details of Alan's 10 Peaks race
- ▼ After 18 whole hours of running, Alan and his Raspberry Pi 'Brick' earned their 10 Peaks medal

“ I was able to raise a few pounds for Alzheimer's Research UK as well ”

IoT Events, DynamoDB, S3, Cognito, Simple Email Service, Lambda, and Elasticsearch Service are used to collect, process, and present this information back to my supposedly interested family members”, he explains.

### Bricks and pieces

“During the event itself, there were several onlookers understandably baffled by the strange bright device attached to the side of my backpack,” says Alan. “A small number were even brave enough to ask! The reaction on Twitter has also been great, and I was able to raise a few pounds for Alzheimer’s Research UK as well.”



# HAL 9000

## Google Assistant



Zach Hipps

Electrical engineer Zach is happiest when he's inventing something and says he "loves to inspire others to make things they're excited about"

[magpi.cc/bytesized](http://magpi.cc/bytesized)

▼ "I don't think I can do that" – creating HAL's case was far from straightforward and involved rethinking the internal setup

A classic sci-fi film was the inspiration for this amazing Raspberry Pi-enabled voice assistant project. **Rosie Hattersley** is impressed

**S**mart speakers have quickly become assimilated into our everyday lives, with the concept of asking Alexa understood even by those who don't make regular use of tech. Self-confessed tinkerer Zach Hipps wasn't content with a standard-issue voice assistant, however. Instead he chose to give his smart speaker an iconic sci-fi film makeover and the sinister voice of HAL 9000. It's based around the Google Assistant which, he reasoned, already ran on Raspberry Pi and there was likely to be plenty of documentation about it. Having a USB port was another point in Raspberry Pi's favour.

### Bits and pieces

One of the most surprising aspects of the HAL 9000 project is how inexpensive it was to build. "I

bought a USB microphone, LED, resistor, push-button, and plastic cupcake containers from eBay," reveals Zach. "The remainder of the parts were designed in Fusion 360 and 3D-printed using my Artillery Sidewinder X1 3D printer." Aside from the 3D printing costs, and the Raspberry Pi 3 (which he already had), the project cost about \$10.

Zach used the Adafruit Retrogame utility to reprogram a GPIO pin to emulate a keyboard button press. The button, enclosed by the plastic dome from a cupcake, looks impressively like the film version. You press this to ask HAL a question from a list Zach created for the project (see 'Hello HAL' box, overleaf).

"The only piece of code I had to write was a quick Bash script that sources the Python virtual environment and runs the Google Assistant software every time Raspberry Pi boots", he says.

“ Aside from the 3D printing costs, and the Raspberry Pi 3, the project cost about \$10 ”

### Perfecting the design

The most time-consuming part of the project was creating and fine-tuning the enclosure for the HAL 9000 Google Assistant so it looked just like the one in the classic film, *2001: A Space Odyssey*. "I imported a photo into Fusion 360 and created a basic sketch. From there I extruded features and added a place for the plastic dome," says Zach.





Zach printed the case in multiple parts so he could use several colours of 3D plastic rather than having to paint it afterwards

Connected to a GPIO pin reconfigured using Adafruit Retrograde, the push-button sits beneath a plastic cupcake cover

"I can see you're really upset about this." It's quite strange being greeted by HAL's measured tones



**Quick FACTS**

- ▶ Zach grew up building things in the garage with his dad
- ▶ He switched to an electrical engineering degree...
- ▶ ...soon after discovering Raspberry Pi. Coincidence? Hmm...
- ▶ He's an ardent fan of our favourite single-board computer
- ▶ He's currently working on a New England covered bridge mailbox notifier

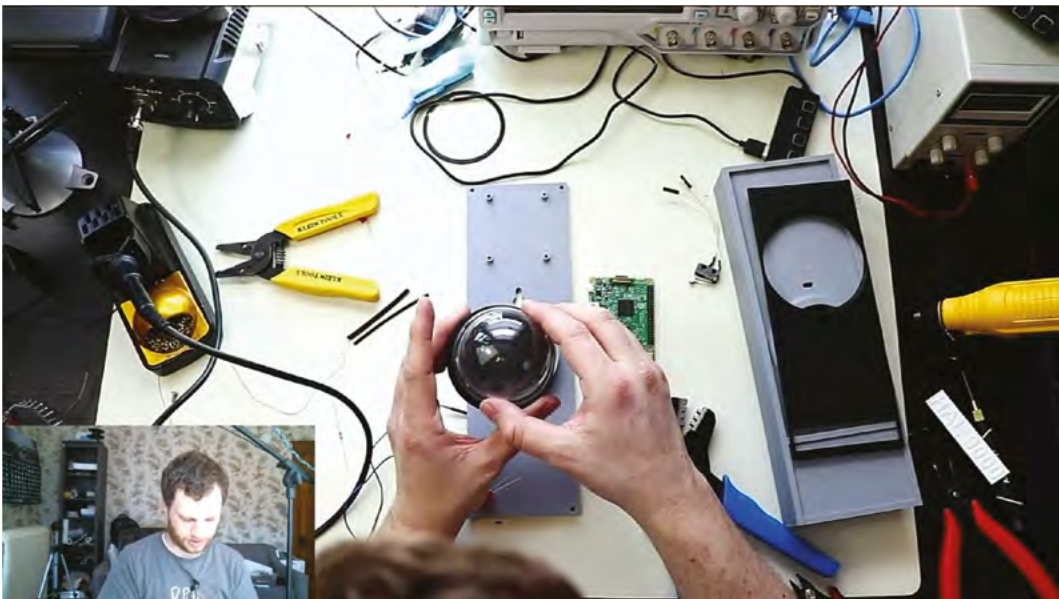

▲ Zach spent hours getting the plastic dome to work as a push-button to activate his HAL 9000 Google Assistant

## Hello HAL



**01** To create your own HAL Google Assistant, set the USB microphone and speakers as default playback and capture devices (you'll need device IDs for each). See Zach's hardware setup at [magpi.cc/hal9000ga](http://magpi.cc/hal9000ga).



**02** Install Google Assistant API on your Raspberry Pi. Create a project in the Google API console ([magpi.cc/googleactions](http://magpi.cc/googleactions)) and create a Python virtual environment script to run the project. Add a command to make it run on bootup.

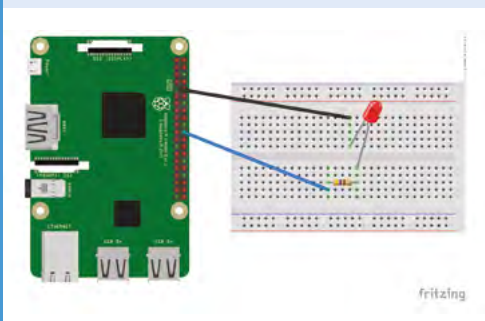

**03** Specify a GPIO pin on Raspberry Pi as your 'push-to-talk' button using Adafruit's Retrogame utility ([magpi.cc/retrogame](http://magpi.cc/retrogame)). Set pressing **ENTER** as the mechanism to activate the talk function. Record a sample question to check it works.

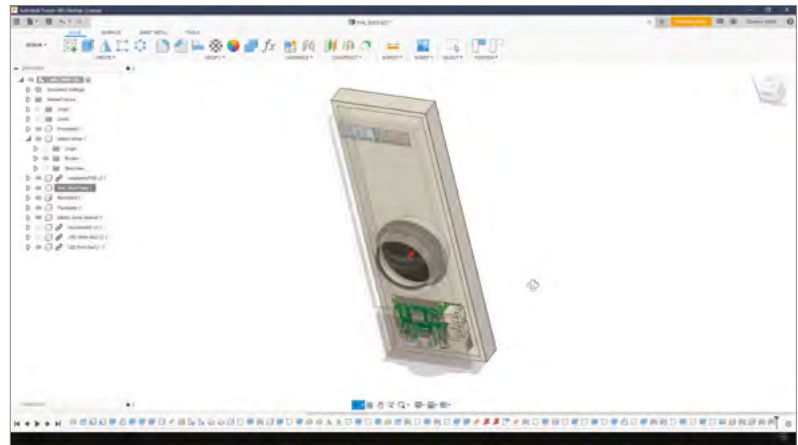

▲ Designing the case in Fusion 360, ready for 3D printing

Getting the cupcake dome to work as the push-button was far from plain sailing. After several test prints and iterations, Zach realised the whole thing was simply too large to print as a single piece: “It was about  $\frac{3}{4}$  inch too big to fit on the bed of my 3D printer, so I had to scale it down.” However, the enclosure still had to fit several existing components. To make it work, he ended up reversing the position of several items. Raspberry Pi ended up at the top, which then meant the speaker and USB microphone connected to it also needed to be repositioned.

“I had to tweak dimensions until everything fitted correctly,” recalls Zach. “A powerful feature of Fusion 360 is that you can design parts parametrically, which means if a test print didn’t fit, I could go back and change one or two parameters and the whole design would update.”

“If a test print didn't fit, I could go back and change one or two parameters and the whole design would update”

Once all the pieces had been 3D-printed – a process taking 30 to 40 hours – assembly could begin. Zach positioned the microswitch in its enclosure and installed the 10 mm red LED with its resistor and the clear dome into the mount. He then connected up all the wires to Raspberry Pi. Finally, he put together the all-important casing that makes Zach’s HAL 9000 such a showstopper.

“I designed the enclosure to be in several pieces so that I could print them in different colours, rather than having to paint the different colours onto one monolithic print. I glued all these pieces together before putting on the back panel and securing it with screws,” he tells us.

“At this point”, he says, modestly, “the HAL 9000 Google Assistant using a Raspberry Pi was complete!”





- ▲ Creating a case that looks just like the original 1968 film version of HAL was a labour of love. Someone suggested it could also make a great photo booth
- ◀ The finished project. "I am completely operational and all my circuits are functioning perfectly," reports HAL

# Apollo Pi

Fans of portable Raspberry Pi projects will love this thermal sensing camera disguised as a 1970s microwave scanner, thinks **Rosie Hattersley**



**Martin Mander**

Martin works in the Intelligence & Analytics department at Norfolk County Council, where he's able to make good use of his love for Internet of Things builds.

[kyliemander.com](http://kyliemander.com)

**H**ere at *The MagPi*, we love a retro project and have previously featured several such builds by serial old-tech upcycler **Martin Mander**. What was to become the latest example – the 1979 Apollo Pi thermal sensing camera – started out as an Arduino project in which Martin and his colleagues at Norfolk County Council challenged each other to design a way of counting library visitor numbers.

When the gauntlet was first laid down, Martin decided it would be a good time to use an Adafruit

thermal sensor he'd already bought. "Our libraries already use commercial thermal visitor counters, so I thought I'd build my own," he reasoned. Years of designing projects has taught him that it's best not to get too hung up sticking with your original plans. Instead, he says, it's best "to get started and see where the project takes you!" He advises: "it's always good to do lots of research up front and have a clear idea of what you want to achieve, but some of the most rewarding projects are those where you make at least some of it up as you go along."



▶ The original Apollo Monitor XI microwave scanner Martin adapted for his project

Apollo Pi is based on a 1979 Apollo Monitor XI microwave scanner

Apollo Pi displays a thermal image of an object, cleverly detecting life forms. Here, the cat's fur is clearly cooler than its body

Pressing the trigger button on the rear tells Raspberry Pi to start sensing the heat of what's in front of it

### Quick FACTS

- ▶ Martin swears by the cheap digital Vernier calliper he got at Lidl.
- ▶ It frequently informs him "that's not going to fit in there"
- ▶ He intends to use Apollo Pi to check for chicks in the garden bird-boxes
- ▶ His Raspberry Pi-based timer tells him when to take a break
- ▶ Look out for his next project on Twitter: [@OldTechNewSpec](https://twitter.com/OldTechNewSpec)



- ▶ Testing the thermal sensor and the display settings for the temperature readings
- ▼ Martin adapted Adafruit's Python code for the thermal sensor. He chose Raspberry Pi because SciPy could use bicubic interpolation to vastly improve the display

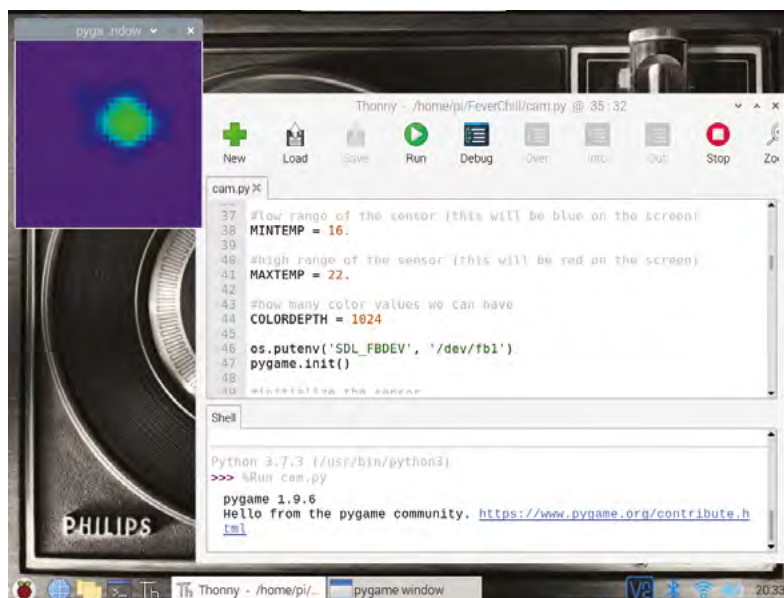

Martin expected it to be a quick build. “I thought I’d pop the components into an old infrared flash gun in an afternoon,” he recalls. Unfortunately, the case was too small, so he had to rethink. Digging around in his dusty boxes of old tech for an alternative, the Apollo monitor caught Martin’s eye. “It really leapt out at me as it was just the right size, and also a perfect ‘hold and point’ shape. It was easy to imagine it as a thermal camera.”

### Change of plan

Parts for the project were sourced online, costing around £70 in all. The biggest expense was the thermal sensor. After connecting the screen, sensor, and Raspberry Pi Zero W, Martin started working out what extra switches he’d need, plus how to power the device. He was able to make use of small bits of leftover plastic as circuit board covers, and spent a long time trimming the original case to make the new components fit.



The screen and sensor are connected to the GPIO pins via jumper cables. To prevent them disconnecting while cramming everything into the grip, Martin hot-glued them in place. With a USB battery pack fitted, he was ready to start testing.

### Altering the script

Software for the project ([magpi.cc/apollopi](https://magpi.cc/apollopi)) is based on Adafruit's Python code for the thermal sensor. "All I've done is added in some extra code to handle more button presses, and some additional integrations with [Adafruit.io](https://adafruit.io), to enable uploading the captured images and using dashboard sliders to set the temperature threshold," explains Martin, modestly.

**"** I thought I'd pop the components into an old infrared flash gun in an afternoon **"**

Apollo Pi took him a month to build, devoting an hour each evening to the project. "I enjoyed taking my time with it and not rushing to finish," he says. As he doesn't have a 3D printer, he had to make everything himself. "A 3D printer would make a much neater job of such tiny parts, but it was incredibly satisfying whittling and filing them by hand!" [🔗](#)

▲ Martin chose Apollo Pi's colours to be redolent of the 1970s, and bought the paint just as DIY shops closed down this spring

## Build your own



**01** Attach the thermal sensor and LCD screen to Raspberry Pi Zero W using jumper cables rather than directly mounting on the GPIO pins.

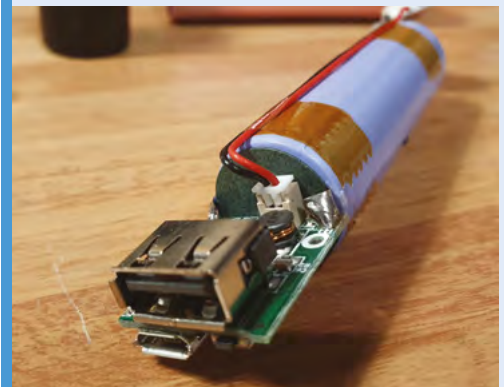

**02** Add a slim USB battery pack and connect it to Raspberry Pi Zero W via a cable with a latching button to turn it on/off. Assemble your customised hand-held scanner so any circuitry is hidden, but leave space inside the case so the trigger can be depressed when you want to scan an object.



**03** Save instruction code to an FTP site, then use PuTTY and Filezilla to instruct Raspberry Pi to power on the display. Sensor info and code can be found at [magpi.cc/apollopi](https://magpi.cc/apollopi).

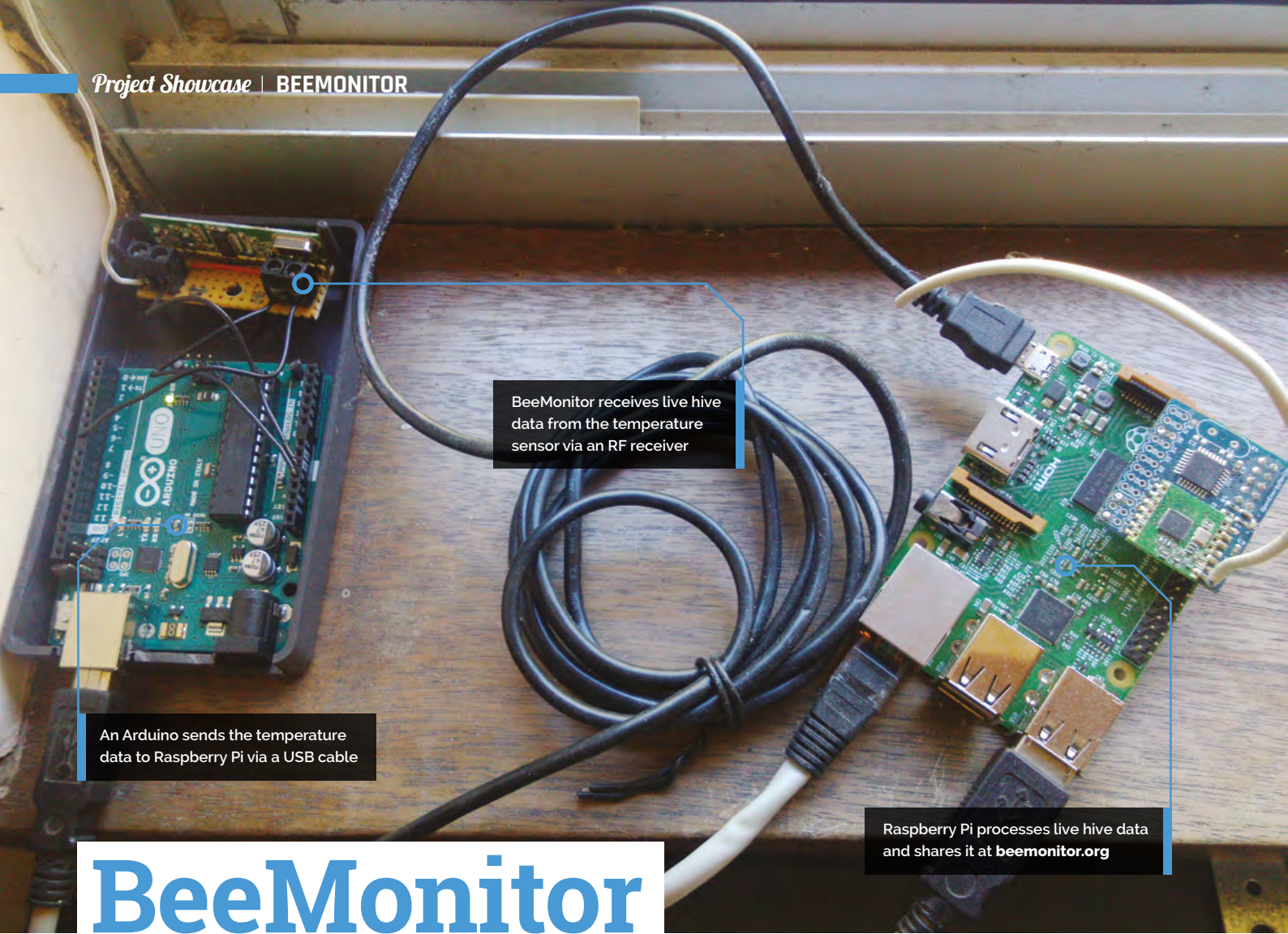

# BeeMonitor

Keeping an eye on bee life cycles is a brilliant example of how Raspberry Pi sensors help us understand the world around us, says **Rosie Hattersley**



**Glyn Hudson**

Having studied electronic engineering at university, Glyn co-founded [openenergymonitor.org](https://openenergymonitor.org), designing and building open-source energy monitoring tools to help people understand energy and optimise energy consumption and generation.

[beemonitor.org](https://beemonitor.org)

**G**etting to design and build things for a living sounds like a dream job, especially if it also involves Raspberry Pi and wildlife.

Glyn Hudson has always enjoyed making things and set up a company manufacturing open-source energy monitoring tools ([openenergymonitor.org](https://openenergymonitor.org)) shortly after graduating from university. With



▲ Glyn checking the original BeeMonitor setup

access to several hives at his keen apiarist parents' garden in Snowdonia, Glyn set up BeeMonitor using some of the tools he used at work to track the beehives' inhabitants.

"The aim of the project was to put together a system to monitor the health of a bee colony by monitoring the temperature and humidity inside and outside the hive over multiple years," explains Glyn. "Bees need all the help and love they can get at the moment and without them pollinating our plants, we'd struggle to grow crops. They maintain a 34°C core brood temperature ( $\pm 0.5^\circ\text{C}$ ) even when the ambient temperature drops below freezing. Maintaining this temperature when a brood is present is a key indicator of colony health."

## WiFi not spot

BeeMonitor has been tracking the hives' population since 2012 and is one of the earliest examples of a Raspberry Pi project. Glyn built most of the parts for BeeMonitor himself. Open-source



▲ BeeMonitor complete with solar panel to power it. The Snowdonia bees produce 12 to 15 kg of honey per year

software developed for the OpenEnergyMonitor project ([emomcms.org](http://emomcms.org)) provides a data-logging and graphing platform ([magpi.cc/emomcms](http://magpi.cc/emomcms)) that can be viewed online.

The hives were too far from the house for WiFi to reach, so Glyn used a low-power RF sensor connected to an Arduino which was placed inside the hive to take readings. These were received by a Raspberry Pi connected to the internet.

At first, there was both a DS18B20 temperature sensor and a DHT22 humidity sensor inside the beehive, along with the Arduino (setup info at [magpi.cc/ds18b20sensing](http://magpi.cc/ds18b20sensing)). Data from these was saved to an SD card, the obvious drawback being that this didn't display real-time data readings. In his initial setup, Glyn also had to extract and analyse the CSV data himself. "This was very time-consuming but did result in some interesting data [[magpi.cc/beemonitorv1](http://magpi.cc/beemonitorv1)]," he says.

“ Bees need all the help and love they can get at the moment ”

### Sensor-y overload

Almost as soon as BeeMonitor was running successfully, Glyn realised he wanted to make the data live on the internet. This would enable him to view live beehive data from anywhere and also allow other people to engage in the data.

"This is when Raspberry Pi came into its own," he says. He also decided to drop the DHT22



### Quick FACTS

- ▶ Apis is the Latin word for bee
- ▶ Glyn's parents are keen amateur apiarists
- ▶ He'd like to add a hive weight monitor
- ▶ This would reveal how much honey the hive produces
- ▶ Glyn documents his project at [magpi.cc/beemonitorgit](http://magpi.cc/beemonitorgit)

humidity sensor. "It used a lot of power and the bees didn't like it – they kept covering the sensor in wax! Oddly, the bees don't seem to mind the DS218B20 temperature sensor, presumably since it's a round metal object compared to the plastic grille of the DHT22," notes Glyn.

The system has been running for eight years with minimal intervention and is powered by an old car battery and a small solar PV panel. Running costs are negligible: "Raspberry Pi is perfect for getting projects like this up and running quickly and reliably using very little power," says Glyn. He chose it because of the community behind the hardware. "That was one of Raspberry Pi's greatest assets and what attracted me to the platform, as well as the competitive price point!" The whole setup cost him about £50.

Glyn tells us we could set up a basic monitor using Raspberry Pi, a DS28B20 temperature sensor, a battery pack, and a solar panel. [🔗](#)

Monitoring set-up on National crown board

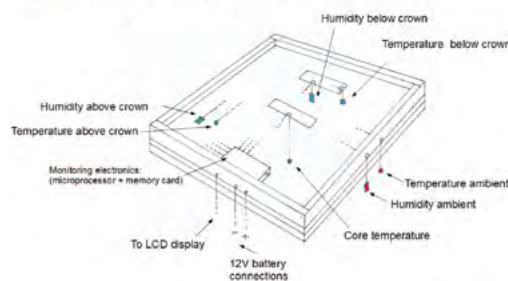

- ▲ Unlike the humidity sensor, the bees don't seem to mind the temperature probe
- ◀ Diagram showing what information BeeMonitor is trying to establish

# Giant Battleships

Play a classic game of Battleships on a giant LED matrix using an antique phone to give orders. **Phil King** dials in



**Dan Aldred**

MAKER

Raspberry Pi enthusiast, NCCE facilitator, teacher, and coder who enjoys creating new projects and hacks to inspire others to start learning.

[tecoed.co.uk](http://tecoed.co.uk)

**O** riginally played with a pencil and paper, the Battleships strategy game sees each player positioning a fleet of ships of varying lengths on a grid. They then fire shots in turn, by issuing co-ordinates, to try to hit the opponent's hidden ships and sink them. A board game version featuring plastic pegs for shots was launched in 1967, later followed by snazzy electronic and talking versions.

Dan Aldred has now taken the concept one stage further by recreating the classic game on a giant colour LED matrix, with the player issuing shot co-ordinates using the rotary dial of an old telephone: [magpi.cc/battleships](http://magpi.cc/battleships).

"After creating my giant 10×10 LED board – which is great for light shows, lockdown discos, and general colour displays ([magpi.cc/ledboard](http://magpi.cc/ledboard)) – I wanted to create a giant game," he reveals. As he had previously coded his own version of Battleships for the Sense HAT, it seemed a natural choice.

In this version, the game is played solo with a limited number of torpedoes to try to sink all the

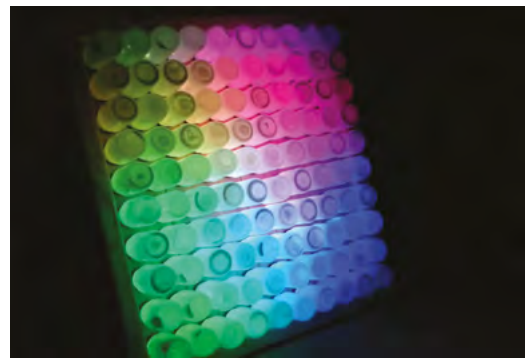

▶ The LED matrix doubles as an impressive disco light show. Dan is considering using it for Conway's Game of Life

randomly placed ships. After a short introduction, the player is asked to select their first co-ordinate. "You simply dial a number and this is then sent as data to the LED board's Raspberry Pi, which triggers another prompt telling the player to dial the second number," explains Dan. "Once the co-ordinates have been dialled in, the board tracks the locations, flashes, and then calculates if the torpedo has hit a boat. If it was successful then a message is sent back to the telephone which triggers a random response consisting of an explosion (sound) and a voice update. If the torpedo misses, different data is sent to the telephone which triggers the miss response, the sound of empty water."

## Double helping of Raspberry Pi

While Dan originally intended to use a single Raspberry Pi for the project, he ended up using two of them – one inside the LED matrix and another in the telephone – to avoid the matrix's NeoPixels interfering with the audio for the sound effects and speech, which is played through the telephone's original handset speaker. "The simple solution was to use a second Raspberry Pi which would be situated away from the LED [matrix]."

Two-way communication between the project's two Raspberry Pi boards is achieved using sockets controlled by Python, although Dan encountered



▶ The giant LED matrix comprises a 10×10 grid of NeoPixels, their light diffused by jars



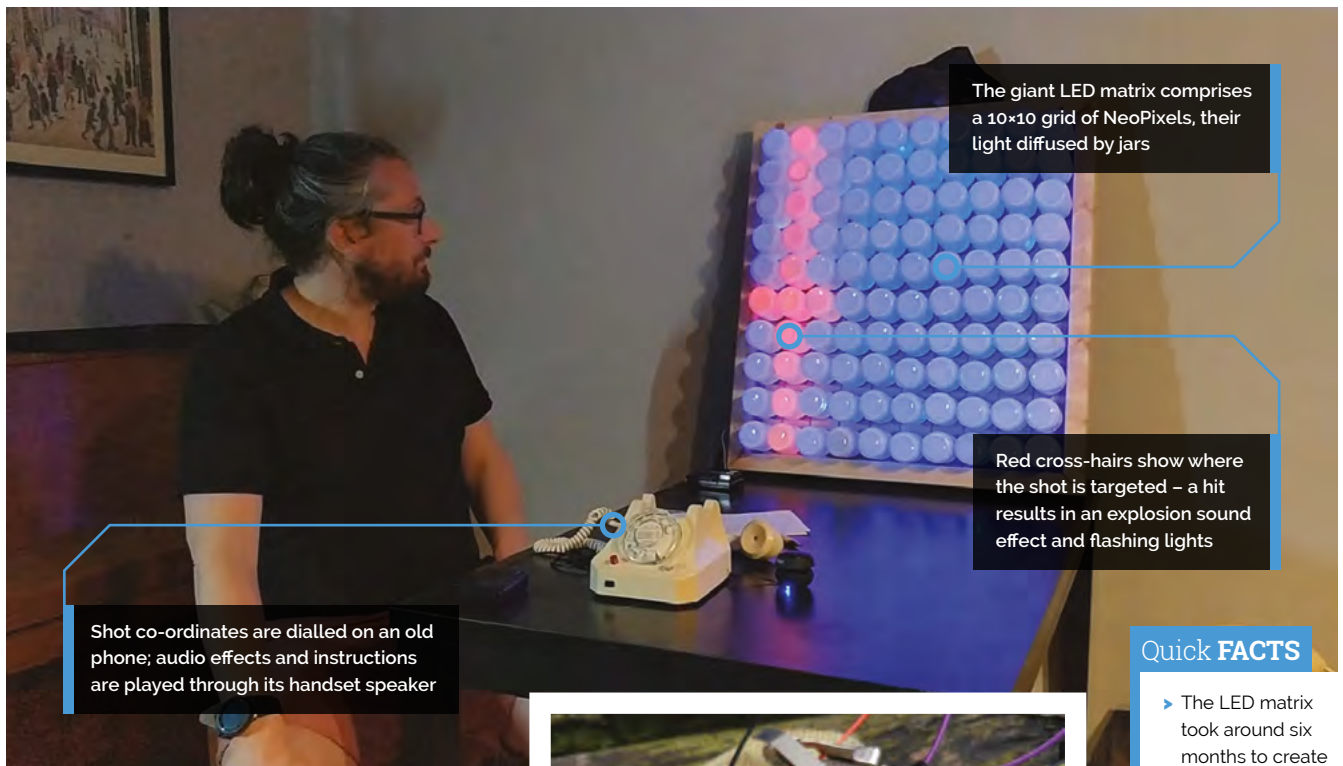

The giant LED matrix comprises a 10×10 grid of NeoPixels, their light diffused by jars

Red cross-hairs show where the shot is targeted – a hit results in an explosion sound effect and flashing lights

Shot co-ordinates are dialled on an old phone; audio effects and instructions are played through its handset speaker

### Quick FACTS

- ▶ The LED matrix took around six months to create
- ▶ Its NeoPixels are diffused by glass jars painted white
- ▶ The Battleships game took a month to develop
- ▶ The phone was bought in an antiques clearance sale
- ▶ Its speaker is wired directly to test pads on Raspberry Pi

some problems. “I did manage to establish one-way communication between the telephone and the LED board fairly early on in the project but could not get the board to communicate back to the telephone, which meant that I could not trigger the gameplay sounds and updates. Big thanks to Nicole Parrot who showed me that I was using redundant code and sent me an example of the new code and from then on it was plain sailing!”

“ You simply dial a number and the data is sent to the LED board's Raspberry Pi ”

### Reading the dial

The method for how the Raspberry Pi reads the numbers from the phone's rotary dial is simple, according to Dan. “Basically, you send a small current from a GPIO pin through the rotary dial and back to a GND pin on Raspberry Pi. When you dial a number, the circuit is broken or interrupted (often referred to as clicks). So if you dial a number one, you get one click, or one interruption; if you dial the number seven, you get seven clicks or interruptions.”

Bought for just £5, the 1960s Bakelite phone had plenty of room for housing a Raspberry Pi. Dan discovered it was made by Swiss manufacturer Zellweger, which used to make government

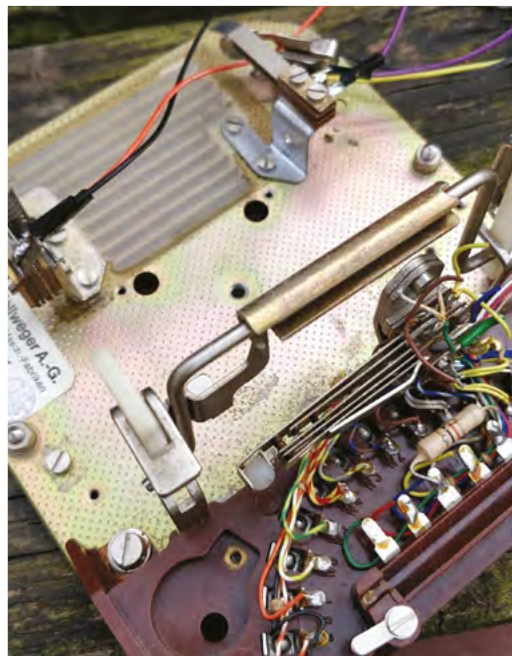

▲ While Dan had used an old GPO phone previously for his Pi Phone project, the mechanism in this Swiss one was completely different

listening devices and phone tapping equipment. “This is where I got excited that perhaps my Swiss telephone had sat on the desk of an important person and been tapped!” says Dan.

While a thorough inspection of all the parts of the phone sadly revealed no bugging device, “There is something quite fun about hearing the instructions and game sounds coming through an old telephone handset.”

# Coffee Maker 'Greenhouse'

Upcycling an old coffee machine into a plant-watering gardening assistant sounds like a latte fun. **Nicola King** filters the facts



**Jeremy Cook**

A US-based maker who enjoys tinkering, upcycling, and giving items a new lease of life.

[magpi.cc/coffeegreenhouset](http://magpi.cc/coffeegreenhouset)

**W**hen his wife's ten-year old coffee maker decided to stop working, Jeremy Cook – a maker who likes to upcycle items – saw an opportunity. He felt that the Keurig machine could still have some use, and so he percolated some ideas for its future incarnation. "I couldn't quite bear to part with such a cool piece of technology," he explains. "The Keurig has a water tank and a means of dispensing water, so it seemed only natural to have it water plants."

## A beans to an end

Having eventually figured out how to disassemble the original machine, Jeremy then turned his attentions to using its features in a new way. "There's an air pump that, when activated, causes water (or presumably coffee) to go out the spout," he says. "It seems that it pressurises the liquid chamber and forces water out this way... As for my setup, the Raspberry Pi activates this air pump at a certain time. The brew button is a manual

“ The Keurig has a water tank and a means of dispensing water, so it seemed only natural to have it water plants ”

trigger for watering. A soil moisture sensor tells the system when it's thirsty (though doesn't control it directly) – when dry, a red light built into the Keurig (and repurposed) lights up. A blue repurposed light signifies that it's watering.”

Ingenuous, and such a great way to redeploy something destined for the scrap-heap, but Jeremy



admits that there were a few challenges along the way, including figuring out the button and light circuitry from only the wires: "I didn't disassemble enough to actually see where they were going."

He also admits that it does still require some fine-tuning, but he's generally pretty happy with his new gardening aid. "I left the outer cover off as I think the internals look cool," he adds, "but I hid all the extra parts in the original electronics cavity inside, so it does look mostly original, if partially disassembled."

## One person's rubbish...

Jeremy is not done tinkering just yet. "There's an unused but hooked-up power button that I may do some sort of lighting test with," he says. "I suppose it is an automatic watering system, but I've had the thought that I could put a tube on it and water larger



A moisture sensor sends data to Raspberry Pi; if it's too dry, the machine's Brew button is lit up in red

The plant pot was created from a 3D-printed mould

plants. Again, more of a thought, but you could get like ten of these for a giant watering system. In this case, solar power would be good, but would kind of mess up the looks.”

Jeremy chose to use a Raspberry Pi Zero W because it was the perfect size to fit inside the Keurig's electronics compartment, along with a mini breadboard. He has used Raspberry Pi computers before, including running his 3D printer via OctoPrint. “I also have a DIY NAS setup that runs on a Raspberry Pi 4,” he adds.

Online feedback on the watering machine has been positive, says Jeremy. “People seemed to think it was a neat idea when I told them about it before it was quite finished, or at least on the internet. I've gotten good feedback from YouTube etc.”

Inspired yet? It just shows what you can do with a little imagination... and a Raspberry Pi, of course! 



### Quick FACTS

- ▶ This project took Jeremy 20–30 hours, over a period of around two months
- ▶ He wrote an article on the build for arrow.com: [magpi.cc/coffeegreenhouse](https://magpi.cc/coffeegreenhouse)
- ▶ A 3D-printed part houses a Raspberry Pi Zero W inside the machine
- ▶ He also grows pineapples in pots made from disposable juice containers
- ▶ His future project plans include a portable oscilloscope

◀ The exposed rear of the machine, showing the various wires and tubes – it's less complicated than it looks

# Piano-Playing Robot

This robot can play scales, chords, arpeggios, or totally new musical scores. **Phil King** listens in



**Étienne Allaire**

MAKER

Étienne is a fourth year undergraduate student in Electrical Engineering at Polytechnique Montréal and plans to pursue a master's degree in Artificial Intelligence.

[magpi.cc/pianorobot](http://magpi.cc/pianorobot)

Looking at the piano in his living room, Étienne Allaire felt a little regretful. “I realised that we played very rarely and found it a pity that such a beautiful instrument remained unused for so long!” he recalls. “That is when I had the idea of a robot that could play all by itself to add to the ambience of the home. It is also a combination of several fields that I love: music, engineering, and artificial intelligence.”

It took him around four months, on and off, to develop his Piano-Playing Robot. As shown in his YouTube project video ([magpi.cc/pianorobot](http://magpi.cc/pianorobot)), it features 15 solenoids mounted on a wooden frame placed on top of an electronic piano keyboard.

“Basically, the system is quite simple,” reveals Étienne. “Each solenoid pushes on a piano key and is controlled by a specific GPIO pin of a Raspberry Pi 3 Model B.” Since the latter doesn’t have enough electrical power to activate the solenoids directly, an electromechanical relay module acts as a buffer between the two.”

“A camera was added to read and decode new musical scores that had never been shown to the robot before”

## Fast ‘fingers’

The system can read a MIDI file, convert it into on and off signals for each note, and play it. A basic UI allows the user to choose between scales, arpeggios, or melodies.



Some of the solenoids are positioned over black notes, enabling the robot to play sharps and flats in various scales and melodies

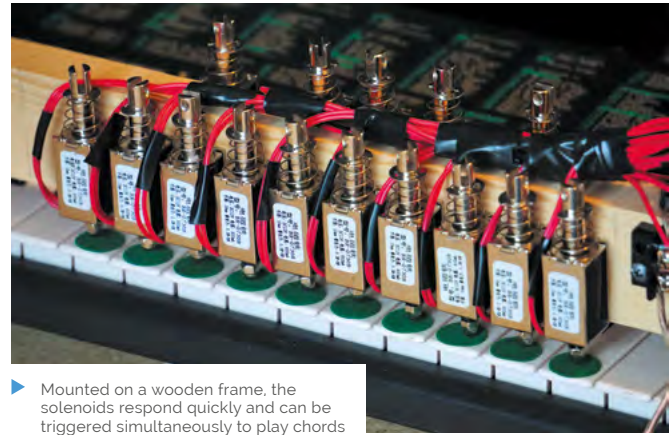

Mounted on a wooden frame, the solenoids respond quickly and can be triggered simultaneously to play chords

“As of now, the robot can play a full scale in just under two seconds,” reveals Étienne. “That is, at the fastest rate, it plays about eight keys per second.” This impressive speed makes it possible to get the timing of the notes just right.

“However, the system is limited by the push and pull times of the solenoids, which add up to a few tens of milliseconds,” he adds. “At a first glance, it may not seem like much, but in a fast melody it can make a difference. Our robot still has a long way to go to overtake human-beings: the fastest pianist in the world claims to be able to reach up to almost 20 keys per second!”

## Sight reading

So far, he has programmed the robot to play six scales, six arpeggios, and five different melodies. The most impressive feature, however, is its ability to read previously unseen sheet music – using a Raspberry Pi Camera Module – and play it.

“A camera was added to the system to read and decode new musical scores that had never been shown to the robot before,” says Étienne. “It then scans, decodes, and plays them.”

To do this, it uses a free open-source tool called Audiveris. “It is a complex program for optical music recognition (OMR), which is recognition of musical symbols. Unlike optical character recognition (OCR), this task requires decoding the

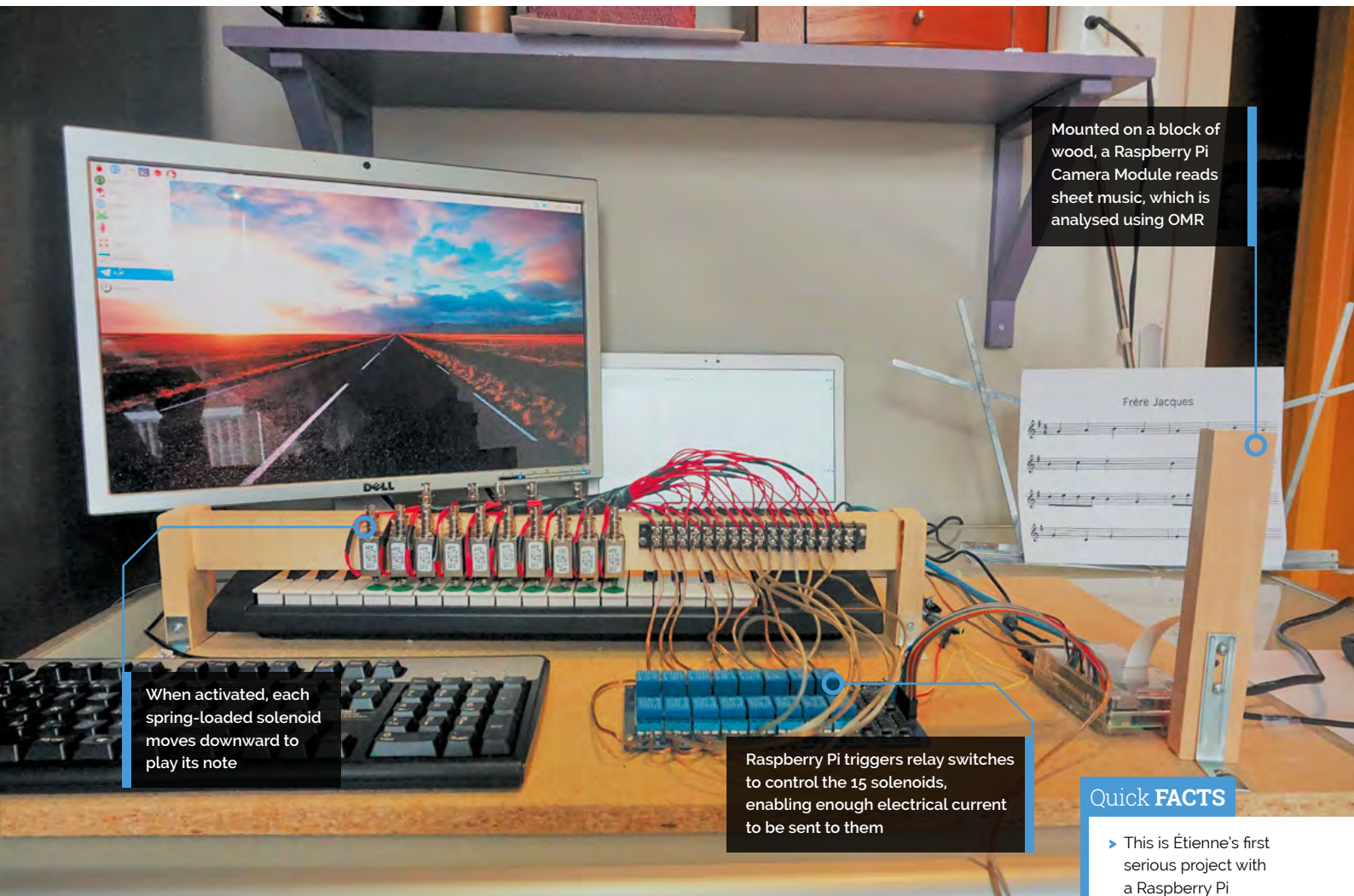

Mounted on a block of wood, a Raspberry Pi Camera Module reads sheet music, which is analysed using OMR

When activated, each spring-loaded solenoid moves downward to play its note

Raspberry Pi triggers relay switches to control the 15 solenoids, enabling enough electrical current to be sent to them

### Quick FACTS

- ▶ This is Étienne's first serious project with a Raspberry Pi
- ▶ The robot took around four months to develop
- ▶ He burned a few transistors at the start of his experiments
- ▶ When activated simultaneously, the solenoids require a lot of electrical current...
- ▶ ...At first, he had trouble supplying them with enough power

configuration of symbols in two dimensions. In addition, the order of magnitude of the symbols is extremely wide (sometimes ranging from tiny dots above musical notes to symbols that are drawn across a large part of the page)."

In brief, the recognition process is done with classifiers and neural networks that make matches with symbols previously learned. "For my project, the decoding part was done on a laptop since Audiveris was more easily compatible with Windows," he explains. "On average, it takes around 30 seconds for the robot to decode a sheet of music containing a few staves."

Étienne is hoping to add extra features to the robot. "In particular, I would like to extend the concept to 88 solenoids. This way, the robot would theoretically be able to play all the existing melodies on the piano! Obviously, there is a lot of development to do in terms of Optical Music Recognition, but I like to imagine a piano concert performed entirely by a robot!" 

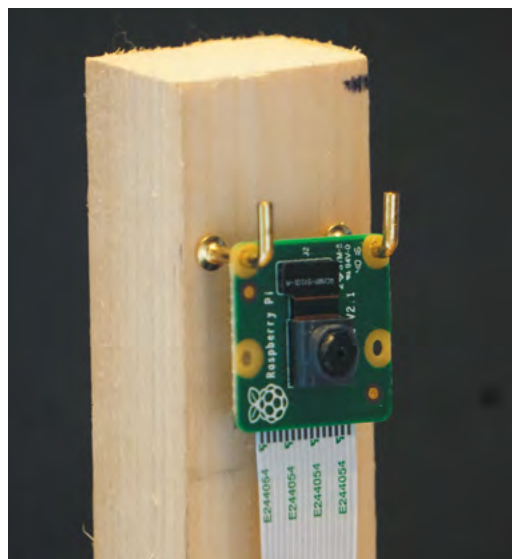

▲ A Raspberry Pi Camera Module is used to read sheet music, its images being analysed using optical musical recognition

# Singing Toilet

A trip to the washroom need no longer be boring – meet the Singing Toilet! **Nicola King** seeks out the heavenly harmonies



MAKER

## Max Björverud

A sound and code artist based in Stockholm, Sweden. Max's work involves musical instruments, museum exhibits, public art, interactive installations, and more.

[bjorverud.com](http://bjorverud.com)

**It may be the ultimate bathroom experience: wall-mounted toilet rolls that 'sing' various notes when the paper is pulled, thus creating an extremely pleasant and calming trip to the smallest room. But how did this very novel idea come to fruition?**

Maker and artist Max Björverud explains that this custom installation was born from a request from a client: “Fredrik Öst at Snask (a creative agency) here in Stockholm wanted something for the toilet. I don’t remember how our conversation really panned out, but a week later I presented the first prototype. The build itself was quite quick, but it needed some iterations to find the best holder and roller. The most difficult part was to make it usable. They need to be able to switch toilet paper without a technician.”

## You gotta roll with it

The system is built around a Raspberry Pi, a HiFiBerry AMP to output high-quality sound to a hidden speaker, and an Arduino Mega to take readings from eight Hall effect sensors. In each

toilet roll holder, a 3D-printed part contains a circular four-pole magnet that triggers the Hall effect sensor when rotated. Whenever it receives data from the sensors via the Arduino, Raspberry Pi outputs the respective sound sample for each moving toilet roll.

“As long as a roll is rolling, the Arduino will send a continuous message telling the Pure Data patch to play that specific sample,” says Max. “It’s built in such a way so that the voice will sing as long as the roll is rolling.”

A few technical issues were encountered in the build process, including random instances of failure to work: “My audio patch (program) consumed 100% CPU and clogged the whole Raspberry Pi,” recalls Max. “That version used windowing functions to create seamless pitch shifting of the samples I used for audio playback. Had to abandon that...”

Max also had to fiddle with the Hall effect sensors for quite a while before he was happy with their placement, and a colleague assisted with the 3D prints, but all their efforts proved worthwhile.

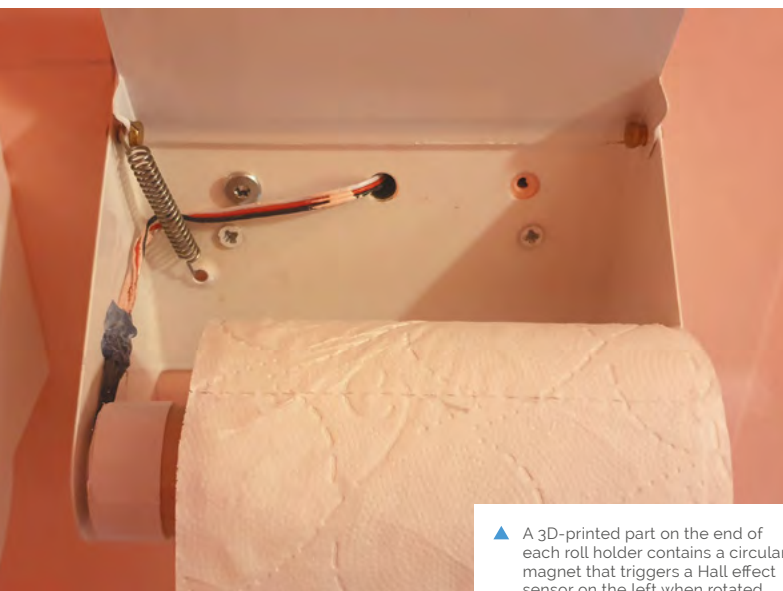

▲ A 3D-printed part on the end of each roll holder contains a circular magnet that triggers a Hall effect sensor on the left when rotated

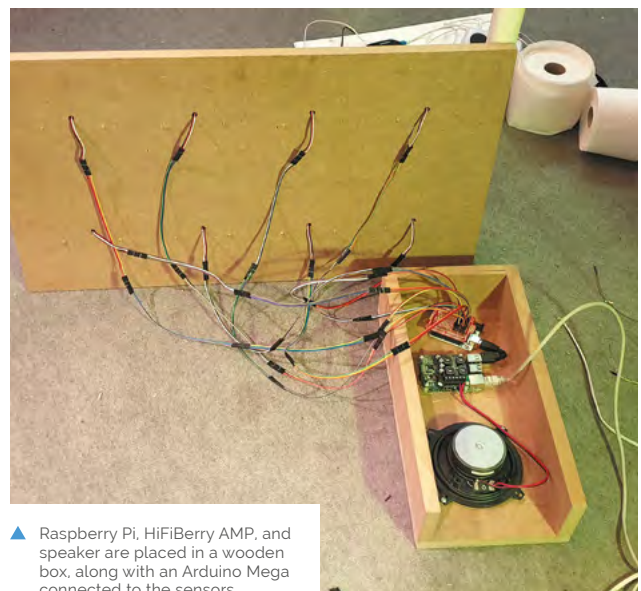

▲ Raspberry Pi, HiFiBerry AMP, and speaker are placed in a wooden box, along with an Arduino Mega connected to the sensors

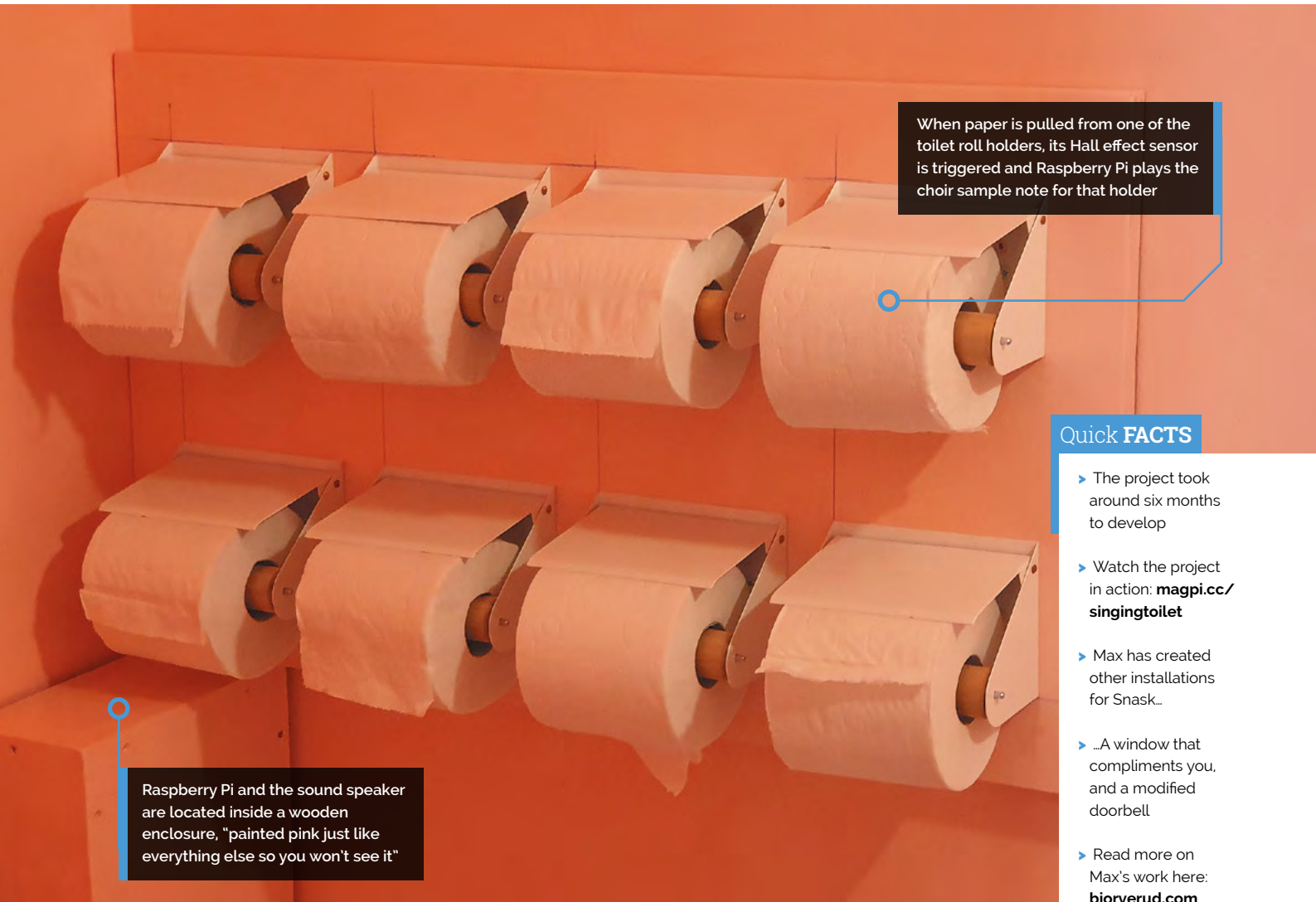

When paper is pulled from one of the toilet roll holders, its Hall effect sensor is triggered and Raspberry Pi plays the choir sample note for that holder

Raspberry Pi and the sound speaker are located inside a wooden enclosure, "painted pink just like everything else so you won't see it"

### Quick FACTS

- ▶ The project took around six months to develop
- ▶ Watch the project in action: [magpi.cc/singingtoilet](https://magpi.cc/singingtoilet)
- ▶ Max has created other installations for Snask..
- ▶ ..A window that compliments you, and a modified doorbell
- ▶ Read more on Max's work here: [bjorverud.com](https://bjorverud.com)

“ It's built in such a way so that the voice will sing as long as the roll is rolling ”



▲ Prototyping the 3D-printed magnet-holding parts that fit onto each toilet roll holder

When it comes to changing the rolls, this is just done normally and the only thing that people need to remember is to put the roll back in the correct direction: “The magnets inside the 3D print must face the Hall effect sensor on the left.”

### Flushed with success

While Max has had great feedback on his creation, “there hasn't been much interaction since people are out of office nowadays. I'm currently learning how to play it so I can hold toilet concerts.”

Integral to the Singing Toilet, and to all his work, has been Raspberry Pi. “[It's] my go-to tool for interactive audio, mainly because I'm so used to it, but also because there's such a great community where any help needed is out there to be found,” Max tells us. “My past projects with Raspberry Pi include a huge dance carpet, a synth made of steel, museum exhibits, and various interactive audio projects.” 



Raspberry Pi PIR sensors hidden above visitors' heads trigger the video projection on to the plates

When no one is in the room, the setup goes into standby and the lights dim

Responsive lighting indicates areas of interest and interactive elements of the exhibition

# Migration Museum

A museum celebrating the diversity of London's residents comes to life when visitors linger near its artefacts. **Rosie Hattersley** discovers more



MAKER

**Chris Owens**

Chris Owens is one of the founders of Clay Interactive, a company that specialises in creating interactive exhibits for museums.

[clayinteractive.co.uk](http://clayinteractive.co.uk)

**A** few weeks before spring 2020's UK lockdown, there was a buzz of excitement among visitors to Lewisham Shopping Centre in south-east London. Slabs from the Berlin Wall emblazoned with brand-new street art greeted visitors at the entrance to the former H&M store, while the storefront display is one of assorted luggage with tags from around the world and many generations.

Thoughtfully curated bookshelves in the gift shop contain tales and memoirs from Windrush Generation writers and set the tone for the rest of the exhibition. The reconfigured former retail unit now contains TV set-like areas with a classroom, kitchen, bedroom, and a hairdresser's shop. Peeking in the bedside drawer or rummaging among the clutter on the mantelpiece, the

curious visitor finds postcards, paintings, maps, and photos revealing the lives of those who made London their home. Taking a seat in the hairdresser's, you're invited to don headphones and listen to the stories recounted by the figure who appears in the mirrored screen. Gazing at the dressed dining table prompts a light to beam images onto the bare dinner plates, with recipes and muttered memoirs of favourite dishes.

## Visual storytelling

The Room To Breathe interactive displays are the handiwork of Chris Owens and his colleagues from Clay Interactive. Commissioned by Aditi Anand, The Migration Museum's head of creative content, they created interactive sets created from artefacts that help tell immigrants' tales.





**Quick FACTS**

- ▶ Chris and his team have projection-mapped food before...
- ▶ ...for an exhibition at The British Library
- ▶ Their data mirror guessed Science Museum visitors' ages
- ▶ But they'd never used Raspberry Pi for a museum project before
- ▶ They're now helping The Migration Museum add more RFID features



“ The technology had to work unattended all day, every day ”

“Our role was to try and make the various rooms in the exhibition as interactive and engaging as possible within their very tight budget,” explains Chris. “We knew we needed to have perfect full HD playback and the technology had to work unattended all day, every day, so reliability was also key.”

Chris says he needed a ‘makers’ mindset’ as off-the-shelf hardware setups typically used by museums were simply too expensive. “Having used Raspberry Pi for a home automation project, I knew a bit about the platform and saw the benefits of the built-in GPIO combined with a compact low-power platform that could support pretty much any programming language.”



- ▲ Framed pictures in the living room become videos of people sharing their memories
- ▲ A dish for making byrek, a traditional Albanian filled pastry

## Interactive display details

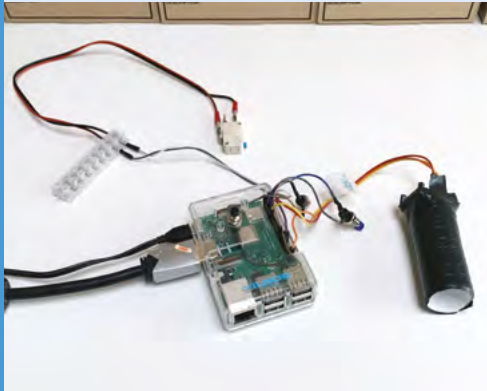

**01** A PIR sensor is used to trigger an object to respond to someone's presence.



**02** The PIR is enclosed in a tube to limit its sensor range, meaning it only triggers when someone is close by.

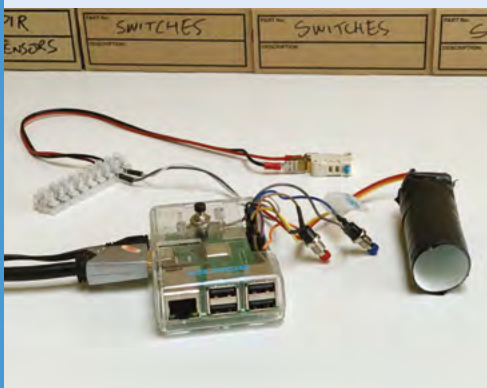

**03** Discreetly placed Raspberry Pi-controlled switches trigger the audio when the headphones are picked up.



▲ Interactive rooms, such as the Golden Scissors barber's, bring personal stories from new arrivals to Britain to life in unexpected ways

They created the digital signage themselves using hardware from The Pi Hut, as well as Amazon. "It was really easy for us to get a prototype of the hardware up and running as the GPIO pins on Raspberry Pi make it easy to connect up and test switches and sensors," says Chris.

### The broader picture

"The PIR (passive infrared sensor) has a very wide viewing angle as it's designed to look at a whole room," says Chris. "We wanted only small areas to trigger the media, such as sitting on a chair or standing very close to something." To reduce the PIR's field of view, they simply put it inside a tube so it could only 'see' what they wanted it to see. Occasionally, the PIR would be triggered by

▼ Like the other items, this case bears a label telling the story of how its owner came to Britain





- ◀ The Migration Museum, housed in Lewisham Shopping Centre, features pieces of the Berlin Wall
- ▼ Postcards, letters, and spoken stories tell children's stories about coming to live in the UK

WiFi activity, but they fixed this by switching off the wireless LAN adapter on Raspberry Pi since it wasn't used for this project.

The team used switches to trigger audio playback when visitors picked up headphones. Other switches were added to restart an audio or video feed, or to shut down Raspberry Pi.

“ The software is mainly just keeping track of whether someone is still present ”

Achieving smooth 1920×1080 video playback was one of the trickier elements. Chris and his colleagues decided to use `omxplayer` ([magpi.cc/omxplayer](http://magpi.cc/omxplayer)) because it can fade in and out. This was controlled using the `omxplayer-control` package ([magpi.cc/omxcontrol](http://magpi.cc/omxcontrol)).

The main program was written in Node.js as that's where their programmer's expertise lay, and also because it offered several useful libraries. Clay's expertise is in creating exhibits with projection mapping, presence detection – ideal for the PIR motion sensors – and two-way mirrors.

“After being triggered and starting to play media, the software is mainly just keeping track of whether someone is still present,” says Chris.



Once there's nobody around, it will stop playing media. In the case of the barber's, the mirror becomes a normal mirror again and, in the kitchen, the animated plates and tablecloth will return to normal.

“Raspberry Pi is a really interesting platform for museum work as it's small, flexible, and cost-effective. Its popularity also means it's easy to get hold of. We are definitely thinking of it as a possible solution to all sorts of needs.”

The Migration Museum is planning a phased reopening when safe to do so. For more details, visit [migrationmuseum.org](http://migrationmuseum.org)

# Project Zed

A sci-fi inspired robot made from old printer parts is helping fight the good fight, just like the character that inspired it. **Rosie Hattersley** explains how



**Joseph Uding**

MAKER

Joseph Uding's robot-building education started with Stan Winston's Hollywood animatronics and MIT's robotics online courses. He's now a project officer at Hive Colab's department of Robotics and AI.

[hivecolab.org](http://hivecolab.org)

▶ The robot can move around, telling people to put on their masks and to keep their distance



**J**oseph Uding first fell for the charms of Raspberry Pi when he was studying robotics with MIT online and was pondering the amount of computing power required for ASIMO, Honda's famous humanoid robot. "The bigger the robot, the bigger the motors and batteries, plus many things that can go wrong because a robot is made up of many computers in it," he reasons. "That's when I started loving Raspberry Pi."

The single-board computer features prominently in Joseph's Project Zed robot, created as a means of encouraging citizens to take sensible health precautions during the coronavirus pandemic. "A friend said 'build a robot that can help in fighting Ebola in West Africa'. That was in 2016 and we didn't take it seriously because no cases were in Uganda, but when 2020 came I got to work. With a robot, he says, "you can carry out random tests and collect information from someone without risking important medical workers."

Raspberry Pi enabled Joseph to add personality and voice-based interaction to the robots he's built, as well as delivering preset messages such as "don't forget to wear a face mask".

## Parts and labour

Project Zed is, by necessity, a masterclass in upcycling: 3D printers and next-day component deliveries aren't reliably available in Uganda, but Joseph believes that if you can have a clear idea of what you want to make, you can make it from almost anything. "The first thing is to see the



Two cameras connected to Raspberry Pi act as the eyes

There's a speaker for a mouth and microphone for listening to commands and understanding people

### Quick FACTS

- ▶ Sci-fi film characters often inspire Joseph's builds
- ▶ Cats' serious expressions are another influence
- ▶ His robots sometimes seem deep in serious chat
- ▶ He loves his Raspberry Pi 3B+ and says..
- ▶ "I can program it to do magic when it comes to robotics"

The rugged wheels of the RC car mean the robot can be used in all sorts of terrain



▲ The robot has four 12V DC motors and a solar panel to recharge the battery if it is out "doing its job in remote areas"



▶ Joseph's first ever robot, TIM, made from a TV antenna, with facial expressions by Google Assistant on an old mobile phone

problem you want to solve with the robot you want to make." His project took him just three weeks.

After work one day, he went to visit some guys who fix printers and asked them for old dead ones. "They smiled and gave me about four spoiled old printers. From there I got DC motors and plastic parts to use when housing the robot." The motors would be used to replace those in a broken RC car that would act as the robot's base and help stabilise it.

“ It can move its arms up and down, but not the fingers yet ”

The initial designs were in lightweight wood he sourced himself – “just like the way planes are made” – which was light and easy to work with. Plastic from the old printers was used for the casing.

Aside from the Raspberry Pi to control things, the half-humanoid, half-RC car robot has a Roboclaw 2 motor controller ([magpi.cc/roboclaw](http://magpi.cc/roboclaw)) and a Google Coral AI USB accelerator ([magpi.cc/coralusbaccelerator](http://magpi.cc/coralusbaccelerator)).

It can be controlled from a distance of up to roughly 400 metres and can listen, talk, and see objects. “It can move its arms up and down, but not the fingers yet,” says Joseph. “It's limited to doing one thing at once – bending down to pick

## Cyber setup



- 01** Assemble parts including an RC motor and create a lightweight wooden or plastic frame. Start with parts for the head to the waist. Join together using glue and screws.

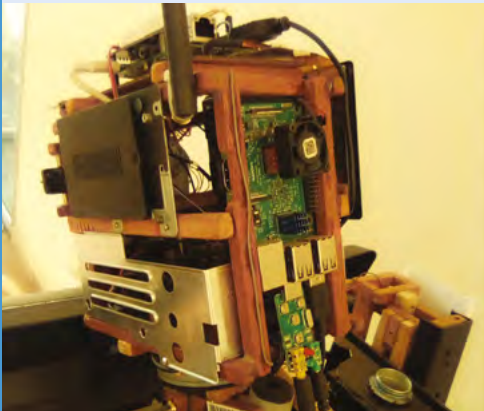

- 02** Fit the robot frame into the RC car, then install Raspberry Pi, webcam, radio speakers, microphones, and Android Things in the robot's head.



- 03** Program the robot to respond to verbal requests, such as tuning in to a specific TV station or finding a recipe. Complete the wiring and robot casing.



something up or moving itself along – because it has only one Raspberry Pi for the head where the AI is based.”

▲ Joseph upcycled an old remote-control car for his robot's base

### Software trials

Joseph first tried using the open-source TensorFlow ([magpi.cc/tensorflow](http://magpi.cc/tensorflow)) and YOLO for object detection, but really had in mind something more like a Movidius Neural Compute Stick to handle face detection (which he didn't have). Instead, having consulted projects such as the Personal Assistant Robot ([magpi.cc/parobot](http://magpi.cc/parobot)), he turned to SSH and live video streaming, which did a great job. “I can control the robot from anywhere around the world using my cell phone or PC any time I want to,” Joseph explains – something with clear potential in war or disaster zones where medical workers' lives would otherwise be at risk.

“Doing such projects where you don't have the actual resources helps you to be good at recycling things and also teaches you how to be super-creative in life,” he says, modestly. [M](#)

# PiMowBot

A pristine lawn is really something, but maintaining it can be time-consuming - unless you have a Raspberry Pi-powered robotic lawn-mower.

**Rosie Hattersley** learns more



**Dirk Weyard**

MAKER

Communications technology specialist and keen DIY maker, Dirk got his first Raspberry Pi back in 2012 and loves its ability to solve real-life problems.

[magpi.cc/pimowbot](http://magpi.cc/pimowbot)

**M**anicured lawns have obsessed homeowners for centuries, giving the illusion of scale as well as order.

However, as our lives become ever busier, maintaining a weed-free, neatly trimmed patch of grass becomes a tall order. Getting a robot lawn-mower to take the strain seems like a sensible solution, especially if, like PiMowBot creator Dirk Weyard, you have a 600 m<sup>2</sup> lawn to keep you busy.

Dirk embarked on his PiMowBot project two summers ago, aiming to create a robot that was powerful and reliable enough to mow his sizeable garden weekly. Although other robot mowers existed, such as the ArduMower ([magpi.cc/ardumower](http://magpi.cc/ardumower)), they didn't fit Dirk's strict lawn-mowing brief in which "the PiMowBot mows the lawn lane by lane so that the lawn gets an even cut." Instead, he set about creating his own robot mower, recruiting his business customer and co-designer Tim Esser



▲ A prototype version of PiMowBot shows off its generous solar panel



PiMowBot's solar panel takes advantage of the fact it's mainly used outdoors on sunny days

to help with the object modelling and 3D design ([magpi.cc/pimowbotcase](http://magpi.cc/pimowbotcase)). One problem: Dirk is based in Schleswig-Holstein in northern Germany and Tim in Berlin, so the two collaborated via email. In fact, they've never met. Both have full time jobs, which meant keeping the project ticking along could be quite a challenge.

Dirk aimed to keep the build costs to around €300 - nearly two years later he estimates the project has cost him nearer €1500, though this includes the cost of two 3D printers and two previous prototypes. Now it's built, there are no significant running costs. "Solar power is free and the built-in hardware is robust and reliable and has no real wearing parts, except the battery," Dirk says.

## False starts

The core parts are a Raspberry Pi Zero, Raspberry Pi Camera Module, and Witty Pi mini (a clock and



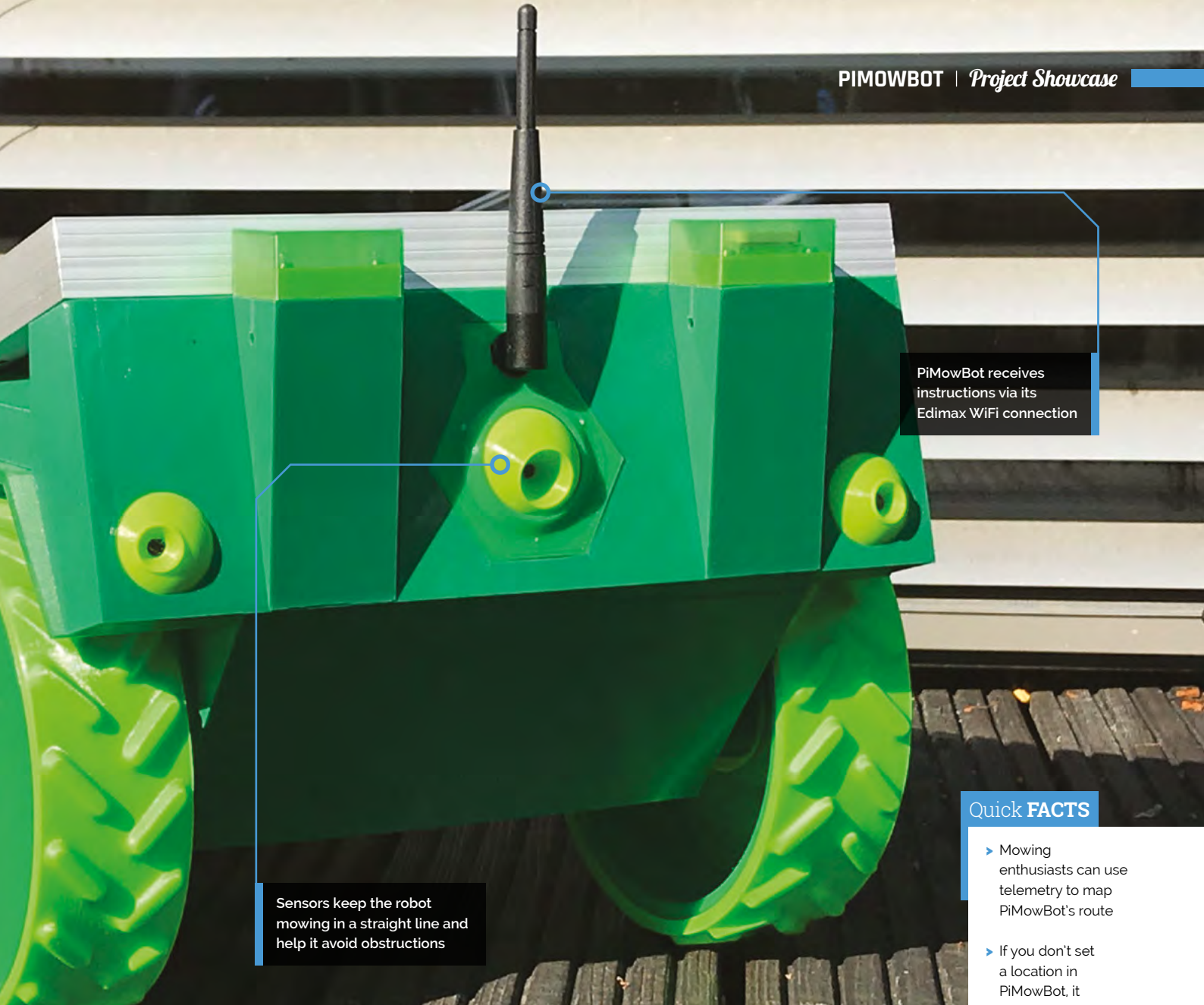

PiMowBot receives instructions via its Edimax WiFi connection

Sensors keep the robot moving in a straight line and help it avoid obstructions

### Quick FACTS

- ▶ Mowing enthusiasts can use telemetry to map PiMowBot's route
- ▶ If you don't set a location in PiMowBot, it automatically selects a default..
- ▶ ..The lawns of one of Cambridge University's colleges!
- ▶ PiMowBot is protected by a geofence theft deterrent
- ▶ It'll have instructions for the most efficient solar-charging alignment

◀ PiMowBot's motor and L298N motor controller hooked up to Raspberry Pi Zero

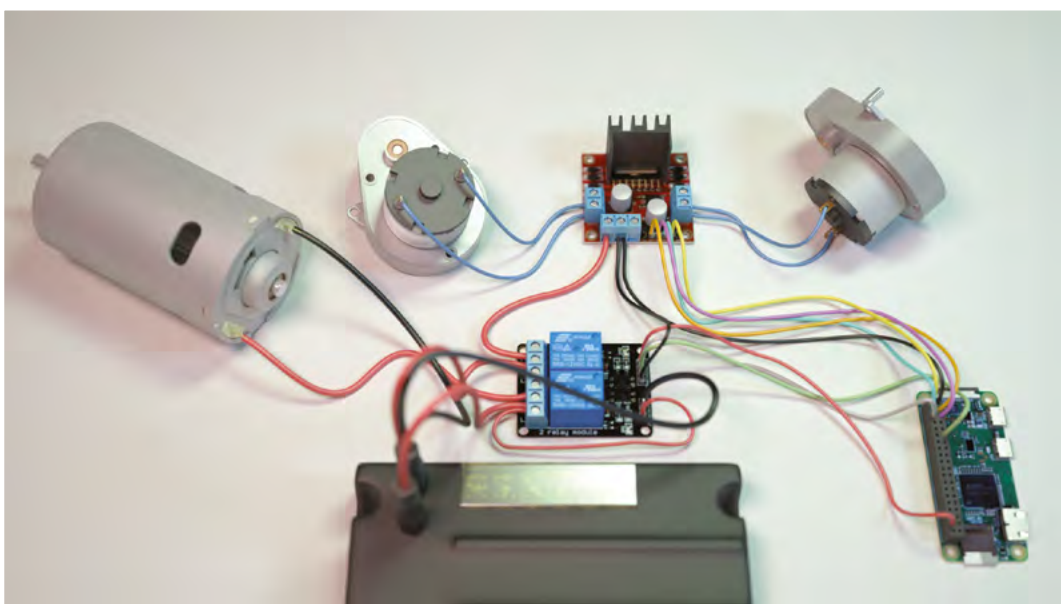

## Make a mower

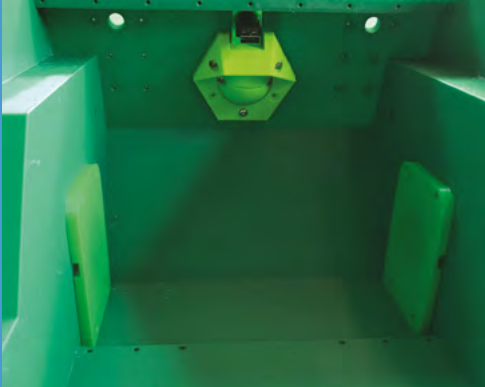

**01** Download the 3D templates from [magpi.cc/pimowbot](http://magpi.cc/pimowbot) or create your own. The PiMowBot software is supplied as a 1MB tarball. Setup instructions are at [magpi.cc/pimowbotsetup](http://magpi.cc/pimowbotsetup).

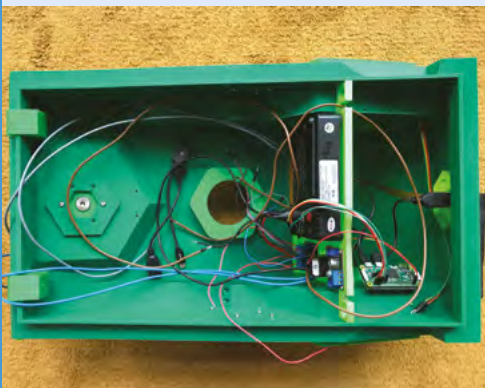

**02** Attach sensors, the L298N motor controller, and other hardware to Raspberry Pi Zero. The full parts list is at [magpi.cc/pimowbotbom](http://magpi.cc/pimowbotbom).

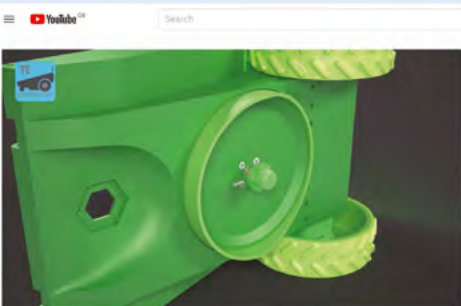

**03** For help setting up the hardware for your Raspberry Pi Zero robot mower, see Tim's videos at [magpi.cc/pimowbotyt](http://magpi.cc/pimowbotyt).

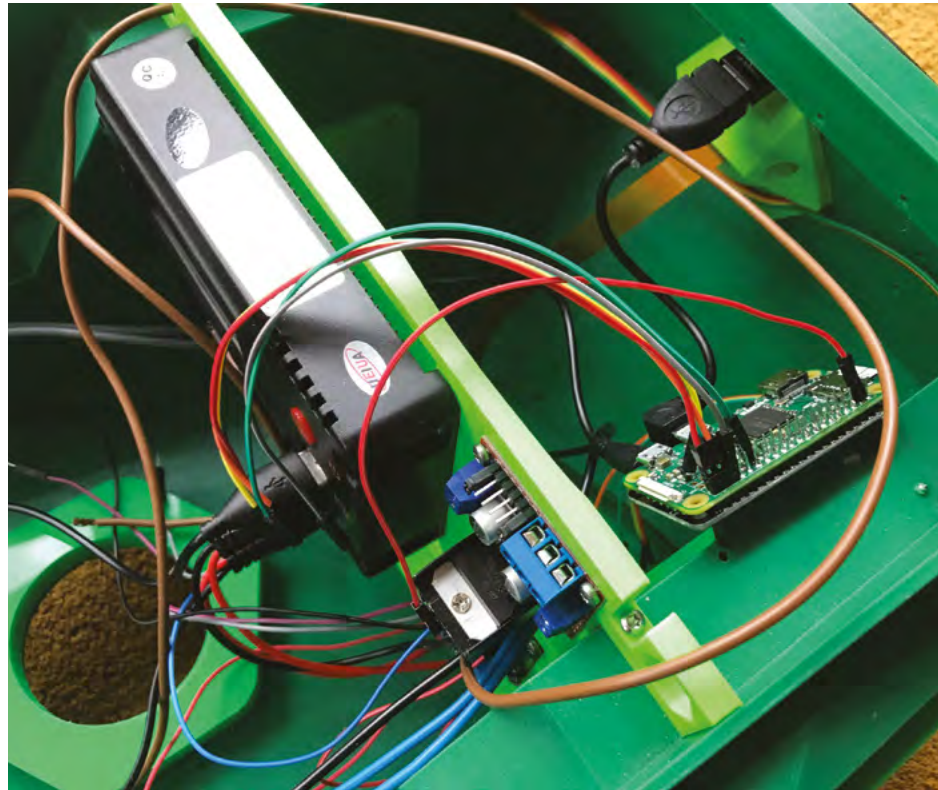

▲ The 3D-printed housing has plenty of room for all the electronic parts

power management module) plus GPS, solar panel, battery, motor, and motor controller.

As well as the Raspberry Pi OS and the Witty Pi software, Dirk made use of standard lines of code from earlier versions of his robot mower. He coded most parts of PiMowBot in REBOL3 ([magpi.cc/rebol](http://magpi.cc/rebol)) since he's been using the open-source functional programming language for nearly two decades. Python and GPIO Zero are used to communicate with the I2C devices, sensors, and motor control drivers.

“ Solar power is free and the built-in hardware is robust and reliable ”

Getting a precise orientation reading was a challenge due to the influence of magnetic north, but Dirk overcame this by getting PiMowBot to automatically go through a calibration process each time it's set up.

He wanted to keep things as straightforward as possible, experimenting with various motors and drivers such as a Waveshare Motor Driver HAT to control the gearing, braking, and acceleration.



- ◀ Sensors check the robot's precise location and confirm which way it's facing before mowing begins
- ▼ A Raspberry Pi Zero is the brain of the automated mower

However, the geared motors drew too much current, prompting a switch to an L298N dual H-bridge module. Further refinements included adding a more powerful motor, which also meant Tim needed to redesign the 3D case.

The final version of PiMowBot was complete by the start of this year, with build instructions and the software all available from Dirk's website: [magpi.cc/pimowbot](http://magpi.cc/pimowbot).

### Mow-tivational

"The PiMowBot has two operating modes: an autonomous operating mode without induction wires in the ground, and a remote control mode to directly control the lawn-mower robot via its web UI and the location and orientation sensors on the lawn," explains Dirk. He's used the Camera Module for previous Raspberry Pi projects and is keen to further refine the optical object/obstacle detection with real-world testing during the summer months.

Although PiMowBot was intended as a "sophisticated hobby project" to work on in his and Tim's spare time, Dirk is planning new models, including an XXL PiMowBot model and an intelligent system in which multiple PiMowBots operate alongside each other and share the mowing task. All hail our future mowing gods! [M](#)

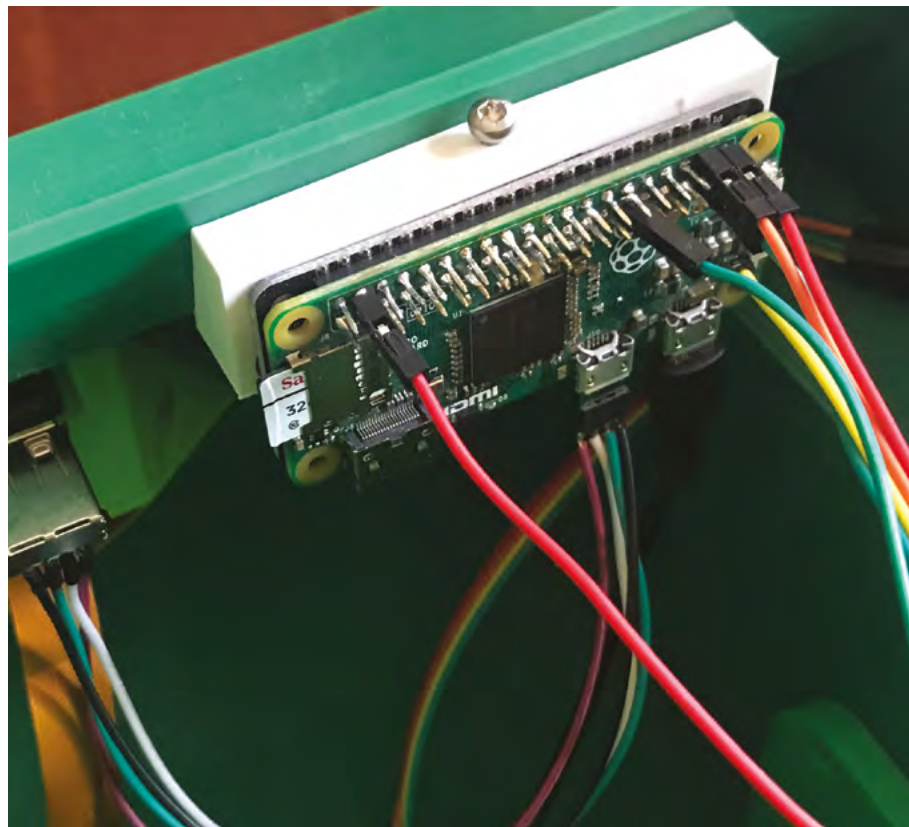

# Retro gaming NES frame

Ashley Green doesn't need to fire up his NES console to enjoy a pang of nostalgia, thanks to his cart-based retro art frame, as **David Crookes** discovers



**Ashley Green**

MAKER

Ashley is an instructional learning designer in London and a self-confessed entry-level geek who's also spent time as a graphic designer and video editor. In his spare time he enjoys looking for creative solutions to non-existent problems.

[nostalgiaop.app](#)

**P**ixel art was once a means to an end: a way of creating graphics in the early days of computers and consoles when visual capabilities were far less advanced than today.

It combined tiny blocks of colour, often using a limited palette, and you only need to look at games from the 8-bit and 16-bit era to see many striking examples.

Today, pixel art invokes pangs of nostalgia and it has evolved into a much-loved digital aesthetic in its own right. Ashley Green is certainly a huge fan, which is why he sought a quirky way of displaying his favourite pixel art, hitting on an idea that also paid homage to the past.

"I'm the proud owner of a few Raspberry Pi computers and I'm always looking for new and interesting ways of using them, with retro gaming being the main driver," he says. "Having previously used Raspberry Pi 3 in a mini-replica NES case, I always thought something was missing: the classic NES cartridge itself. There's something extremely satisfying about handling physical media that you don't quite get with emulation."

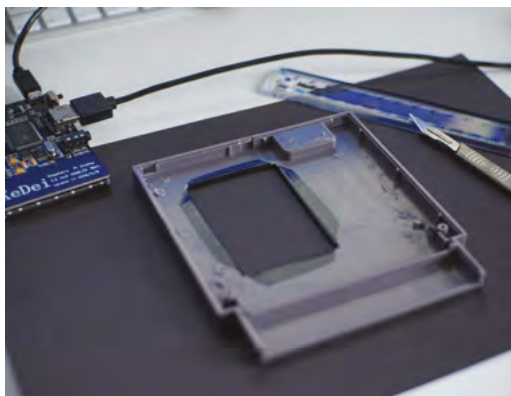

▲ Be careful: the case will need to be cut. Ashley has also used black vinyl for a finishing touch

By opting for the WH model of Raspberry Pi Zero, the 40-pin GPIO header is professionally pre-soldered, allowing for a simple connection with the display



▲ As well as connecting via GPIO, Raspberry Pi Zero can be simply hooked up using cables

## Playing with power

Rather than amass a large collection of cartridges – "I didn't want to break the bank or shelves with stacks of old games" – Ashley felt that a single cart could be used to showcase the style of art he loves.

Inspired by a project that turned an NES case into a full handheld system complete with screen and controller, he decided to turn a cartridge into an art frame which could then be placed in his study as a constant reminder of the past.

"I thought it would allow me to appreciate the time and effort that went into the artwork and give me a little preview of classic NES games," he reveals.

## Let's-a-go!

Grabbing a Raspberry Pi Zero W and a 3.5-inch screen that he was using for another project, he got to work. "Not wanting to destroy an original cart, I searched online and found a new blank cartridge shell. All I then needed was the USB and HDMI cables as well as a slim battery pack."

Since the screen is placed in the area usually reserved for the cartridge label, the build required



**Quick FACTS**

- ▶ No original carts were harmed
- ▶ Connect the screen via GPIO for a slim fit
- ▶ The battery packs last for about six hours
- ▶ The media can be streamed via WiFi
- ▶ Yodeck is free for single-screen use

The project uses a 3.5-inch 320×480 LCD HDMI screen to display the retro footage

Search for a 'replacement cartridge shell' online if you don't want to damage an original cart

“ Pixel art invokes pangs of nostalgia and it has evolved into a much-loved digital aesthetic ”

some cutting into the plastic. Most of the project, however, involved setting up the software, with Ashley using the cloud-based digital signage app Yodeck. This allowed him to create, schedule, and upload videos and images from his computer or smartphone, although he says OXMPPlayer would work well for offline creations.

“I found the best process was to upload media and create a playlist that I could place on a layout that suited the screen,” he says. “I’ve chosen to use mine to show a mix of artwork, game footage, and classic NES commercials, but I’ve also used it to show off an action RPG called Induction Quest, which I created in Unity. It certainly makes for a great conversation piece – I’ve had a few people ask me what it is during my work video calls.”



▲ Ashley has framed his cartridge, shown here running footage from his own game, Induction Quest. He's currently working on SNES and VHS cassette versions

# Black Lives Matter projection



A Raspberry Pi-controlled video projection proclaims the rights of Black people. **Rosie Hattersley** gets the message

MAKER

## Kareem Rahma

Egyptian-American Kareem is a NY-based artist and media entrepreneur. He co-founded The Nameless Network and The Museum of Pizza and previously worked at VICE.

@kareemy



MAKER

## David Dellanave

Entrepreneur David is a coach, gym owner, and olive oil importer who has been deeply involved in open-source technologies since the late 1990s.

dellanave.com/  
oliveoil

**B**efore daybreak one morning in June 2020, a huge 120×100 ft (30.5×36.5m) video projection appeared on the wall of the Gold Medal Flour Mills building in Minneapolis. Gil Scott Heron’s iconic track *The Revolution Will Not Be Televised* played over a looped set of images and video clips featuring US civil rights leaders. The installation was a powerful message of how things must and will change. The thought-provoking projection is powered, of course, by Raspberry Pi.

Its creators, artist Kareem Rahma and entrepreneur David Dellanave, were only too happy to fill *The MagPi* in on how the project came about.

### Historical significance

Kareem explains: “The idea was to display a juxtaposition of peaceful protestors with violent, oppressive police and elevating the names of Black people who have been killed by police in America.” Having had the germ of an idea for such a project, New York-based Kareem tweeted asking for someone to help him make it happen. Minnesotan David, who he’d worked with a decade previously, responded. The two worked remotely until the time came to install their project at its location.

David suggested making use of Raspberry Pi. He describes it as his “go-to for small projects and display dashboards” at the gyms he administers, rather than politically charged public statements. “I’ve never done anything outside the realm of the strictly practical, so this was a cool opportunity to be a part of,” he says.



Raspberry Pi Zero auto-mounts the USB drive and plays images of important civil rights campaigners and video clips of historic speeches stored on it

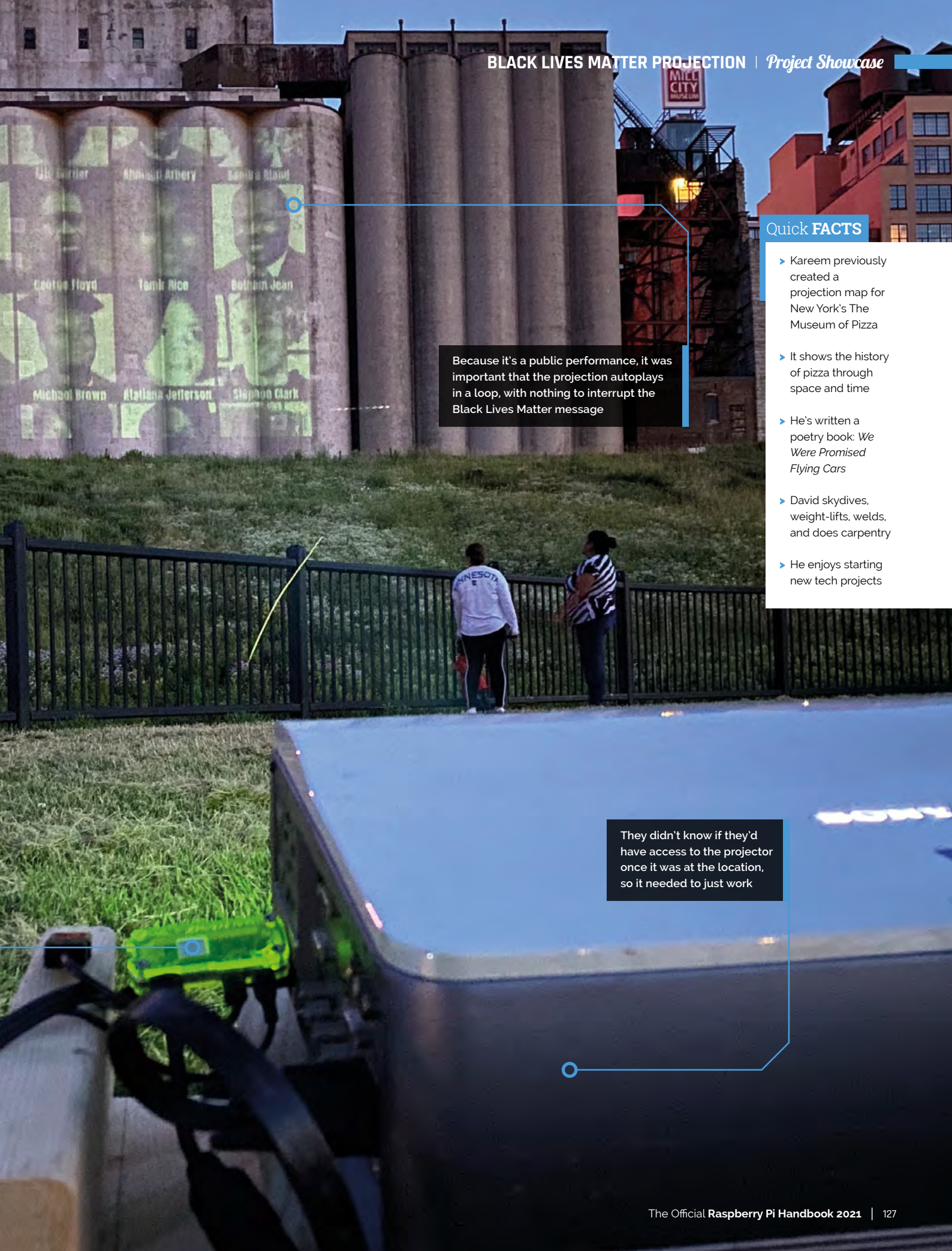

**Quick FACTS**

- ▶ Kareem previously created a projection map for New York's The Museum of Pizza
- ▶ It shows the history of pizza through space and time
- ▶ He's written a poetry book: *We Were Promised Flying Cars*
- ▶ David skydives, weight-lifts, welds, and does carpentry
- ▶ He enjoys starting new tech projects

Because it's a public performance, it was important that the projection autoplays in a loop, with nothing to interrupt the Black Lives Matter message

They didn't know if they'd have access to the projector once it was at the location, so it needed to just work



▲ The projection featuring iconic civil rights campaigners, such as Martin Luther King, can be seen across Minneapolis

▶ Raspberry Pi Zero's low cost appealed partly because the setup might get confiscated or destroyed



▲ David usually uses Raspberry Pi for displays at his gym





Due to the nature of the project, there was always a risk that “the setup could get confiscated or destroyed,” says David. “So it was a huge advantage to have hardware that was cheap enough to be practically disposable.”

Kareem is also a newcomer to public art displays, though he did help produce a projection mapping project for The Museum of Pizza in New York!

For the Black Lives Matter projection, Kareem says: “We wanted to do something that would shock people a little bit, make them uncomfortable, and take advantage of this period of calm that was happening at night-time due to politicians successfully suppressing protests.” They worked with producer Hayley Pappas, creative director Smiley Stevens, and editor Khalil Anderson in Los Angeles to produce the first set of images and videos. Subsequent sets of content



for the display were suggested by the local community in Minneapolis, as well as including transcribed speeches by Malcolm X, James Baldwin, and leaders.

▲ Kareem previously helped create the story of pizza through time for a dedicated Museum of Pizza. Only in New York, right?

“ With protests in cities across the US resulting in government-imposed 10pm curfews, their projection was a risk ”

### Long-distance protest piece

Minnesota-based David already had all the parts the project required. “I chose the non-wireless Raspberry Pi Zero specifically so there were no remote attack vectors possible. It’s more than powerful enough to play the content with no issue.”

He built a small tiltable platform for the projector from wood scraps in his garage. The setup runs off a small generator, so it’s mobile and not dependent on a power outlet.

The software side worked perfectly from the first go, he says. The advice of other Raspberry Pi and commodity hardware users “cannot be overstated” says David, who admits he’s not the most talented coder or software engineer.

Any tweaking needed was to get the optimum projection location so it covered the entire Gold Medal Flour building. “The site is historic, iconic, and massive. It’s also central to Minneapolis and can be seen from different parts of the city,” explains Kareem. With protests in cities across the US resulting in government imposed 10pm curfews, their projection was a risk.

Responses to the projection were immediate and very enthusiastic. “We’re very happy with how the idea has been received and hope that our project has inspired others,” says Kareem. “We’d love to see others replicate the idea, especially with permanent installations!”



### Warning! Public projection

Be mindful of local laws regarding public screening in your area. Seek permission from the owner of the wall or projection surface, or provide your own screen. Adhere to public safety regulations. And be mindful of broadcasting regulations in your area. You need a ‘non-theatrical’ film licence to show films and TV programmes in public in the UK.

[magpi.cc/  
projectionlaw](http://magpi.cc/projectionlaw)  
[magpi.cc/showingfilms](http://magpi.cc/showingfilms)  
[magpi.cc/filmlicence](http://magpi.cc/filmlicence)

# The Swirl Machine

Make fantastic art with wine using The Swirl Machine. **Rob Zwetsloot** picks a nice merlot and proceeds to 'swirl his style'

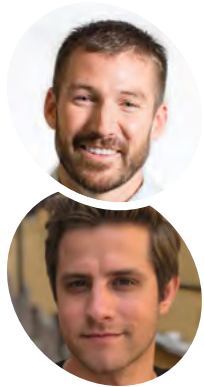

**MAKER**  
Rob Gaedtke,  
Jonathan  
Rutheiser

KPS3 is an integrated marketing agency that works with companies across the globe to find insights in data and bring them to life.

[magpi.cc/9yrkJW](http://magpi.cc/9yrkJW)



## Warning! Spinning glass

If you choose to recreate this project, please fix glass on a spinning turntable carefully (and at your own risk).

▶ Thousands of pieces of art have been created – is your piece on display?

**A**rt comes in many forms, and for this project it takes the form of an interactive wine art creator called **The Swirl Machine**. It's a lot more complicated than it might sound, though.

"The Swirl Machine is an interactive, digital-meets-the-real-world machine that swirls Santa Maria Valley wine and turns it into a digital piece of art," say the team from KPS3, the marketing agency behind The Swirl Machine. "It was created and developed by KPS3 for Visit Santa Maria Valley. The machine allows users to select their 'Fill Level' and 'Swirl Speed'. In real-time, the user can watch the glass fill, swirl, and splash the wine onto a piece of paper, creating an original Santa Maria-style spill artwork. Every swirl and spill will be unique to each individual user."

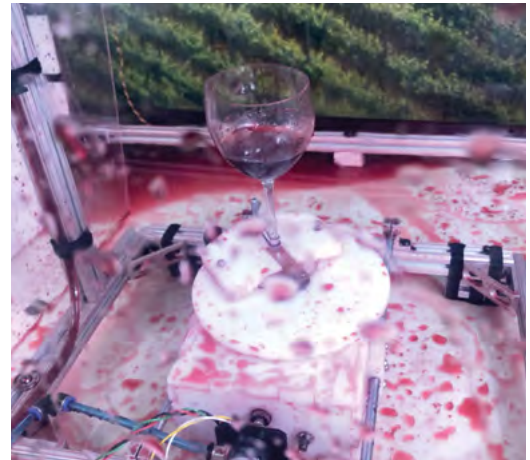

▶ A lot of art creates a lot of mess





A sucker arm picks up paper for creating your art

The wine glass is filled and swirled to your specifications

Your art is affixed here for its close-up

It's a bit like a Rube Goldberg device, albeit without the *Powerhouse* music playing. The result of your swirl is sent to you as a photo, and there's even a fun personality result that comes with it.

"The idea came on a car ride to Santa Maria Valley," the KPS3 team explain. "The team was playing around with the idea of capturing slow-motion swirls, which led to how interesting wine spills are, and that led to The Swirl Machine. The

**“** In real-time, the user can watch the glass fill, swirl, and splash the wine onto a piece of paper **”**

fact that it was a spill fit perfectly into the vibe of Santa Maria Valley's wine experience... if you spill a little, no one really cares. And because of who KPS3 is as a company, it clearly had to push technical boundaries."

### Making a splash

At the time of writing, there have been around 2000 'swirls' on The Swirl Machine's website ([magpi.cc/9yrkJW](http://magpi.cc/9yrkJW)), and the machine has been made possible thanks to a Raspberry Pi.

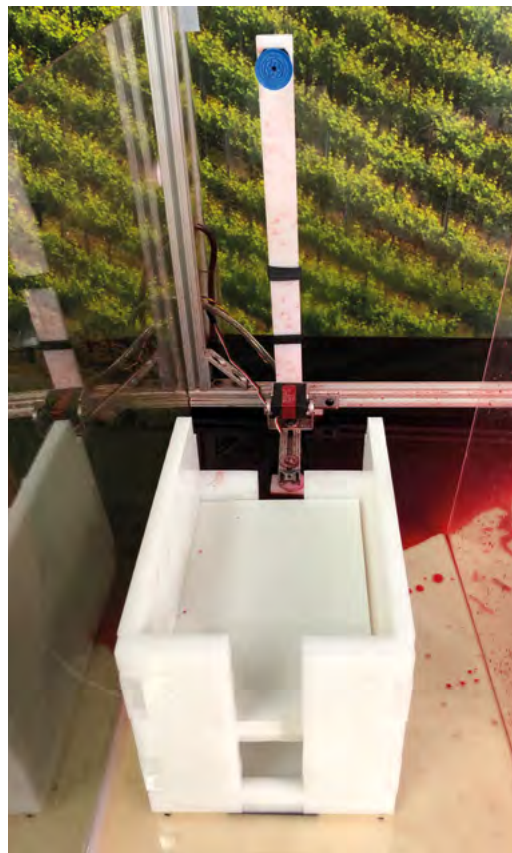

### Quick FACTS

- ▶ The video of a user's swirl can be replayed
- ▶ The Swirl-analysis takes into account the final art and your settings
- ▶ The queue lets you watch the swirls ahead of you
- ▶ More than 1600 people have created about 2000 swirls
- ▶ Art is very cool, however you make it

◀ We love the arm with an air compressor that sucks up paper

## Swirl your style

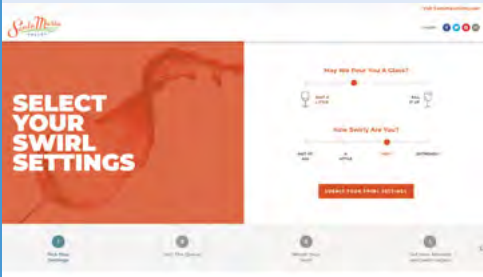

**01** First, you need to select how full the wine glass is. This tells the pump how much wine to dispense into the glass. You can also choose the amount of 'swirl' for your glass, which sets a target speed for the spinning wine plate.



**02** A gripper arm with an air-compressor-powered suction cup grabs your piece of special paper. It brings it to the paper holder, where the paper is then moved into position. Wine is dispensed, the glass is spun, and art happens.



**03** A camera records the footage of the swirl, and a different camera takes a picture of the final piece. As the wet paper isn't perfectly straight, the image is processed to make it look perfect before being shared with the creator.

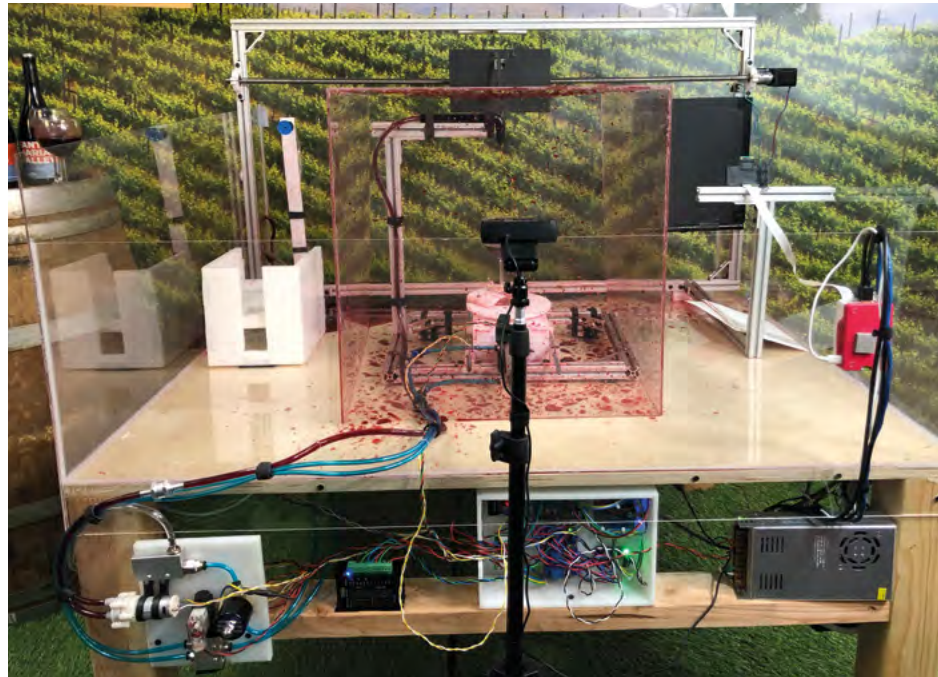

▲ The complete machine is a masterpiece of messy art and many electronics

“We like Raspberry Pi because it has a very low barrier to entry,” the KPS team say. “For only \$35 you get a fully functioning computer with I/O capabilities. The community behind Raspberry Pi is also active and helpful, which means you get software packages that are thoroughly tested and you never spend too much time figuring out solutions to problems. We’ve used Raspberry Pi on many different projects in the past [...]. Whether it’s powering a media server, emulator, live-streaming client, or The Swirl Machine, we know it’s more than powerful enough to handle the tasks we’ve thrown at it.”

The machine uses a number of technologies. The website is hosted in AWS. A robot arm grabs paper and moves it along the swirl production line. Arduinos control the wine glass, and a spinning plate swirls the glass. Each piece of wine art is unique, including the corner splash that we managed to make during our go with it. [\[M\]](#)



▶ A Raspberry Pi takes photos of the final piece

# THE OFFICIAL Raspberry Pi Beginner's Guide

The only guide you  
need to get started  
with Raspberry Pi

## Inside:

- Learn how to set up your Raspberry Pi, install an operating system, and start using it
- Follow step-by-step guides to code your own animations and games, using both the Scratch 3 and Python languages
- Create amazing projects by connecting electronic components to Raspberry Pi's GPIO pins

Plus much, much more!

£10 with **FREE**  
worldwide delivery

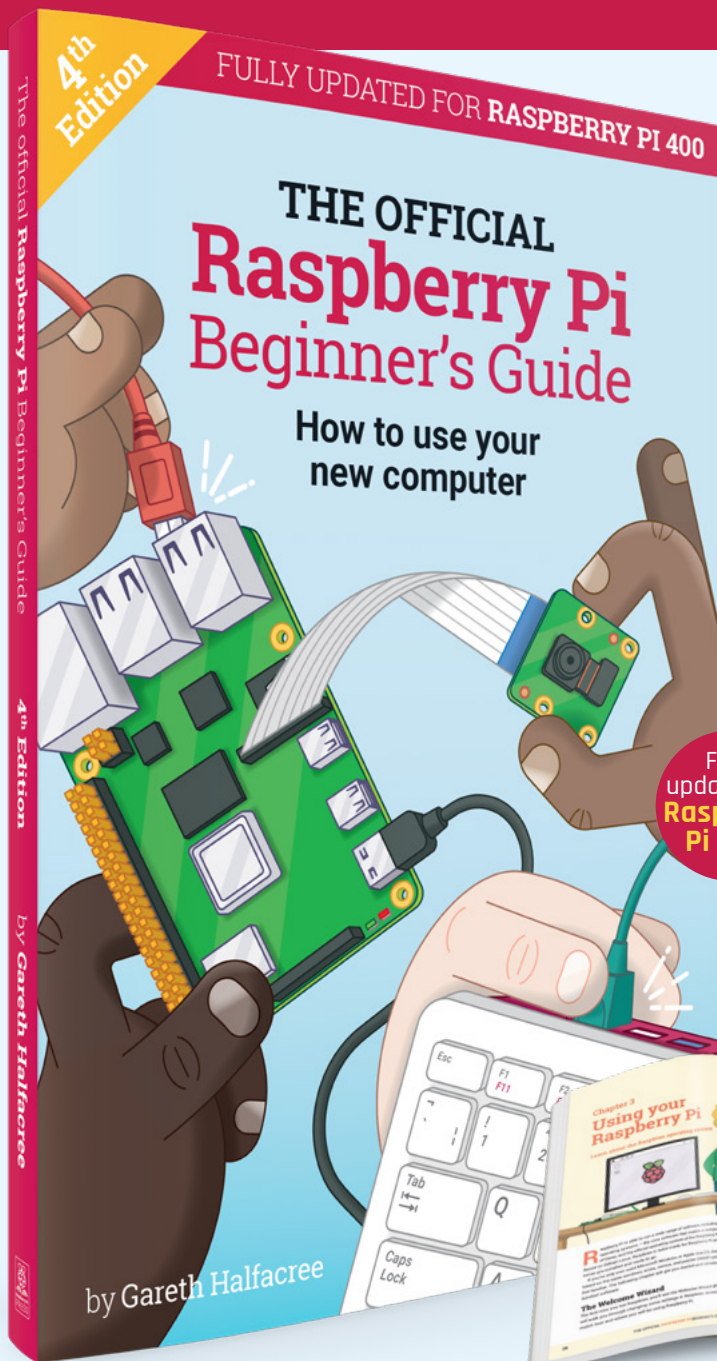

Fully  
updated for  
Raspberry  
Pi 400!

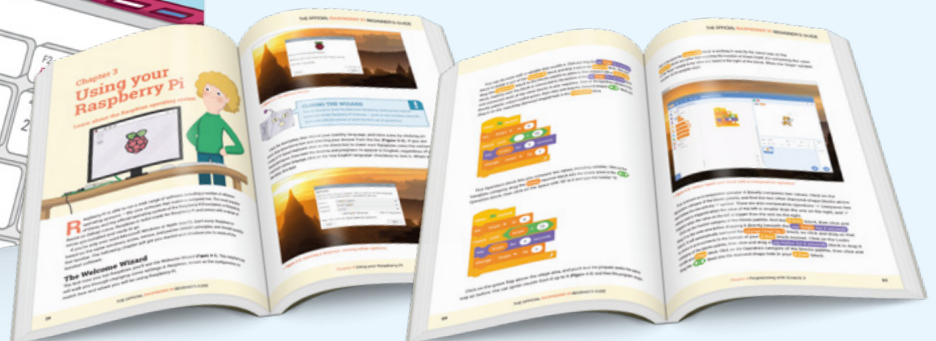

Buy online: [magpi.cc/bgbook4](http://magpi.cc/bgbook4)

# Maker Guides

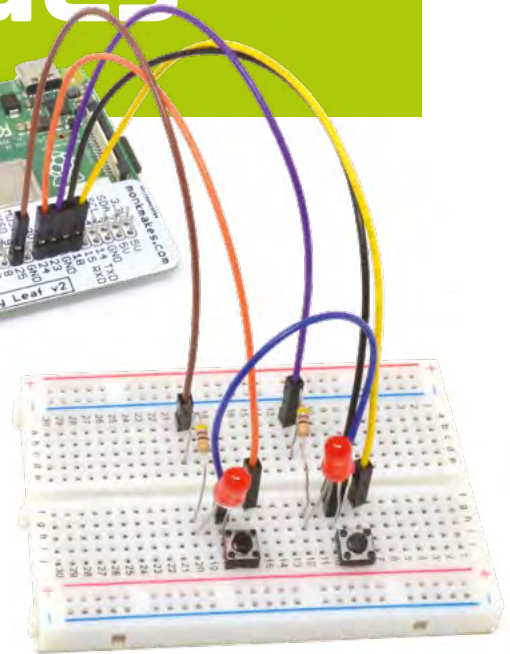

## 136 50 Raspberry Pi Tips and Tools

A huge range of physical and digital tools to improve your making skills

- 139 Tools for building and prototyping
- 140 Tools for storage
- 141 Tools for connecting electronics
- 142 Tools for soldering

## 50 RASPBERRY PI 4 TIPS & TOOLS



## 144 Starter Electronics with Raspberry Pi

If you bought a Raspberry Pi to learn how to make electronic gizmos, you're in for a treat

- 147 Make an LED light circuit
- 148 Basic prototyping components
- 150 LEDs and switches
- 152 Build a reaction timer

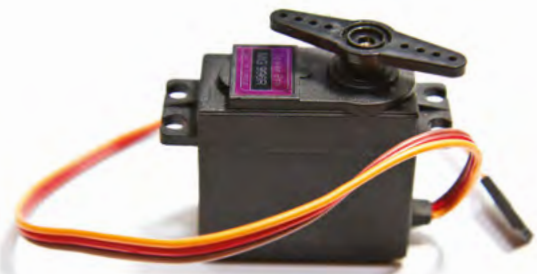



## 154 Build the Ultimate Magic Mirror

Everything you need to make this popular Raspberry Pi project

## 156 Assembling a simple mirror

## 158 Setting up

## 160 Voice control

## 162 Configuring your magic mirror

## 166 Facial recognition

## 170 Create modules for your mirror

## 174 Raspberry Pi Problems Solved

Diagnose and fix issues on your Raspberry Pi

## 176 Basic problems

## 180 Boot problems

## 182 Network problems

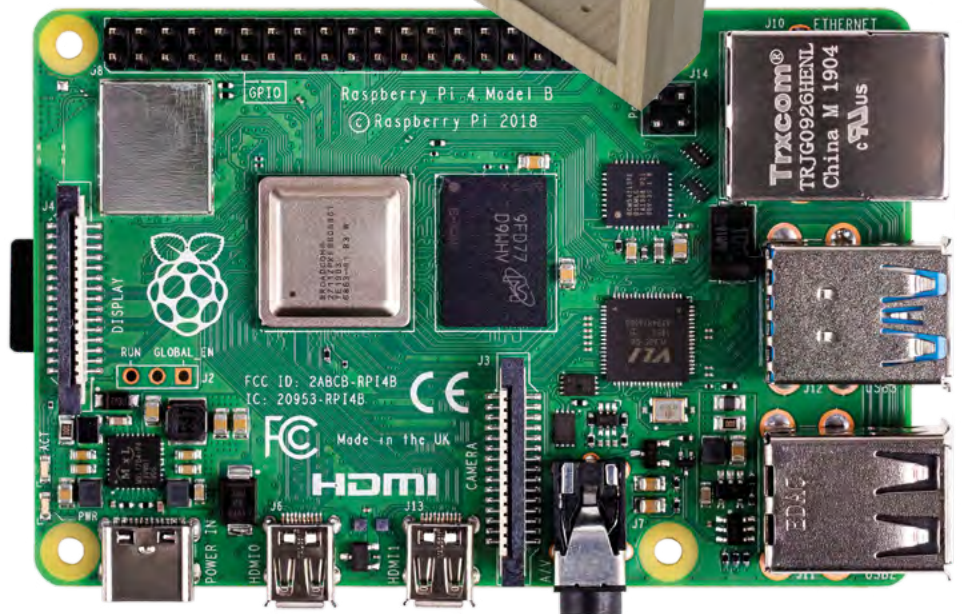

# 50

RASPBERRY PI 4

TIPS & TOOLS

THE RANGE OF TOOLS YOU CAN USE FOR MAKING IS HUGE.  
HERE ARE 50 PHYSICAL AND DIGITAL TOOLS TO IMPROVE  
YOUR MAKING SKILLS. BY **MARK VANSTONE**



### Warning!

Some of these tools use mains electricity and heated parts. **Always** follow connection instructions and **never** leave heated elements unattended.

**W**hether you are new to making with Raspberry Pi or have been at it for years, there are always new tools and techniques to be learned. For the new arrival to the making community, this list will be a great resource to introduce you to tools that you may not have heard of before, and a short cut to get to the bits of software that work best for Raspberry Pi projects. If you've been doing this for a while, you may want to count how many of these tools are already in your makerspace. If you get to 50, you probably need a bigger makerspace.



01

## 3D PRINTER



The 3D printer is a fairly recent addition to the maker scene. To be able to print something solid a few years ago was like science fiction, but now it's a reality. Printers come in many sizes and prices, so you can match your printer to your budget and requirements. There are several choices for filament too, such as PLA (a good beginner's choice) or ABS and many other more specialised types. If you have the time and patience, you can get a small unassembled one for less than £100, but for better quality (and less frustration) you may want to spend a bit more.

Motors move the print-head and heated flat bed in three dimensions as the melted filament is built up in layers

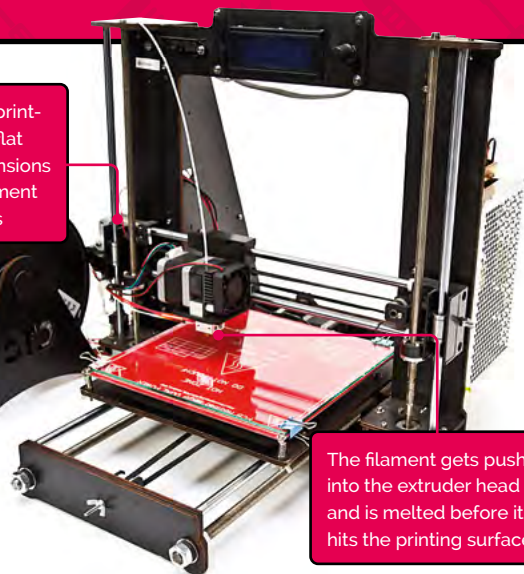

The filament gets pushed into the extruder head and is melted before it hits the printing surface

Printing something solid a few years ago was like science fiction

02

## BREADBOARD



Breadboards are solderless circuit boards and allow for fast prototyping of projects. The boards come in several sizes and consist of a matrix of small connector holes into which components and jumper wires can be inserted to make circuits.

[magpi.cc/breadboard](http://magpi.cc/breadboard)



03

## SPEAKER



Some projects need to make a noise, and the sound quality depends on the type of speaker you use. There are small piezoelectric speakers if all you need are beeps and pops; alternatively, you may need a larger dynamic speaker.

[magpi.cc/piratemini](http://magpi.cc/piratemini)

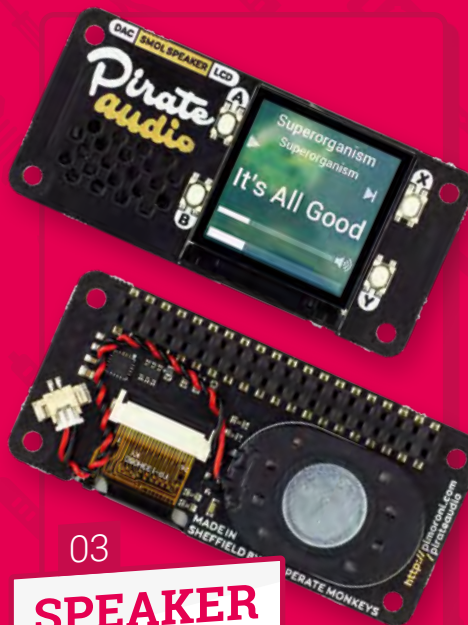

### Affordable 3D printing

Pick up a copy of *The MagPi* #69 to learn all about affordable 3D printing. [magpi.cc/69](http://magpi.cc/69)



04

## LEDS



LEDs (light-emitting diodes) are a bit like very small and efficient light bulbs. They glow when current is passed through them, but they need to be connected correctly. Because they are diodes, the current only flows one way, unlike in conventional light bulbs.

[magpi.cc/leds](http://magpi.cc/leds)



05

## RESISTORS



Resistors are used in electrical circuits to reduce current flow. They are used for many reasons, including changing the brightness of an LED. They can be a fixed value, with stripes to indicate the resistance; or variable, with a slider or dial to change the resistance.



[magpi.cc/resistorkit](http://magpi.cc/resistorkit)

06

## MOTORS



When a current is applied to an electric motor, a spindle in the centre rotates. It spins because of an electromagnetic field that is caused by the flow of current. Motors come in all kinds of sizes, from mini drone motors to industrial ones.



[magpi.cc/motors](http://magpi.cc/motors)

07

## DIODES



Diodes are known as semiconductors because they only conduct electricity in one direction. This can be useful for a number of reasons; for example, to protect your Raspberry Pi from being damaged if you are connecting it to motors.



[magpi.cc/diodes](http://magpi.cc/diodes)

08

## SENSORS



There are many types of electronic sensors. You may want to detect light or vibration, sound, or heat. There are sensors for all of these and many more. Sensors allow us to capture data about the world around us.

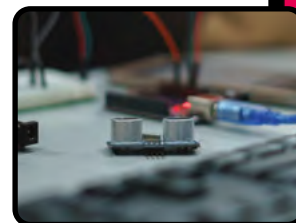

[magpi.cc/sensors](http://magpi.cc/sensors)

09

## CODE EDITOR



There are several code editors available for Raspberry Pi. The default one now pre-installed in Raspberry Pi OS is Thonny. If you are feeling adventurous, you could try installing Mu or PyCharm.

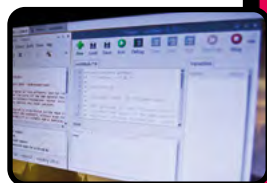

[magpi.cc/texteditors](http://magpi.cc/texteditors)

10

## SSH AND VNC



If you want to run your Raspberry Pi headless (without monitor, keyboard, and mouse), you will probably want to connect to it by typing in commands using SSH, which provides a terminal, or you can have a windowed version with VNC.

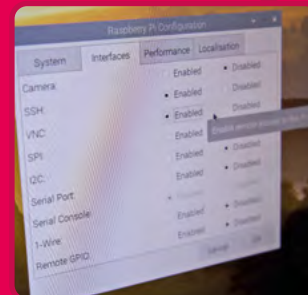

[magpi.cc/vnc](http://magpi.cc/vnc)

# TOOLS FOR BUILDING & PROTOTYPING

## 11 Clamps

For holding bits of your build together until it's stuck or you need to change it.

## 12 Crocodile clips

Connect one component to another without soldering, tape, or breadboard.

## 13 Crimping tool

Pinches connectors onto wire, fixing it to the connector. Can also cut/strip wires.

## 14 Screwdrivers

You're going to need several different screwdrivers of different sizes/types.

## 15 Craft knife

Stanley knives are good for most work, but you might also want something lighter.

## 16 Tweezers

Tweezers can get you out of a fix when that little screw disappears.

## 17 Hot glue gun

Sometimes there is no substitute, but it's not suitable for the young 'uns.

## 18 Hand drill

Most of the time a cordless is best.

## 19 Saw

Hacksaws for metal/plastic parts, jigsaw/circular for big builds, mitre saws for angles.

## 20 Pliers

A good set of long-nose/snipe-nose pliers should be on hand at all times.

21

## IMAGER



Because your Raspberry Pi generally relies on being booted from an operating system on a microSD card, you will require a way to write that data first. The open-source program you need for this is called Raspberry Pi Imager.

[magpi.cc/imager](https://magpi.cc/imager)

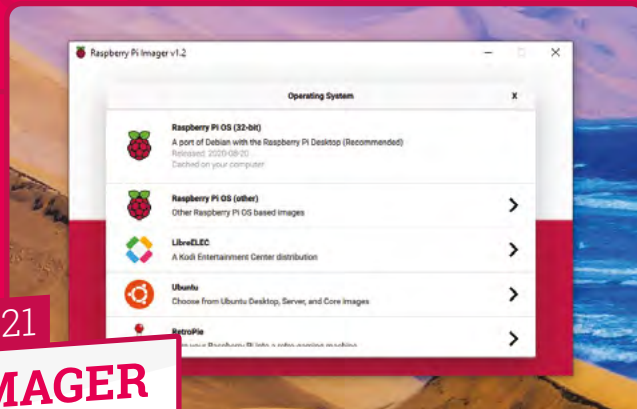

If you are making any sort of moving robot, you're probably going to need wheels

22

## GEARS & WHEELS



If you are making any sort of moving robot, you're probably going to need wheels or gears. Some kits come with them, such as the CamJam EduKit 3. You can buy them separately or even 3D-print them.

[magpi.cc/edukit3](https://magpi.cc/edukit3)

## TOOLS FOR STORAGE

### 23 USB stick

Add extra storage to your Raspberry Pi with a USB thumb drive. You can store more files than the microSD card, and you can transfer files from another computer to your Raspberry Pi.



### 24 Memory card

Make sure you have multiple microSD cards. An 8GB card can be used to install Raspberry Pi OS and other operating systems. It's a good idea to have your regular microSD card and at least one other card for testing out projects.

### 25 Storage box

When making projects, you quickly rack up additional kit – not to mention cables, components, and Raspberry Pi boards. Keep everything in one place by adding a storage box to your shopping list.

### 26

## CARD TRIMMER



A card trimmer will enable you to cut crisp straight lines in paper or thin card. It's much quicker than a ruler and craft knife. Small ones are good for trimming photos, and a good-quality trimmer will last for years.



[magpi.cc/papertrimmer](http://magpi.cc/papertrimmer)

### 27

## ROBOTIC

## CRAFT CUTTER



These machines are very much like plotters, but have a knife instead of a pen. They can cut very intricate designs out of paper and fairly thick card. They can be a bit temperamental and often need a sticky carrier sheet to work well.



[magpi.cc/vinylcutters](http://magpi.cc/vinylcutters)

### 28

## LASER CUTTER OR ENGRAVER



Laser cutters and engravers fire a laser at a material to either cut through it or to leave a mark or indent on the surface, depending on the intensity of the laser. Very effective for cutting irregular wooden shapes.

[magpi.cc/lasercutter](http://magpi.cc/lasercutter)



### 29

## LAMINATOR



Lamination is the process of coating a material with a plastic film. This protects the material from moisture and other damage. It also makes the material thicker. Plastic laminate comes in various thicknesses and surface finishes.

[magpi.cc/laminator](http://magpi.cc/laminator)



30

**CONDUCTIVE PAINT**

Generally coloured black and supplied in a tube, this paint can be used to draw electrical circuits on paper or card, or to improve poor connections between components and even to create touch-sensitive areas on materials. Dries in a few minutes.

[magpi.cc/electricpaint](http://magpi.cc/electricpaint)

31

**ACRYLIC &****THERMOPLASTIC SHEET**

Acrylic plastic sheeting is very tough and can be cut using a saw or CNC router, whereas thermoplastic sheets are malleable when heated with a heat gun. Once cool again, thermoplastic retains its new shape.

[magpi.cc/plasticsheets](http://magpi.cc/plasticsheets)

32

**POLYMORPHIC PLASTIC**

This material is usually supplied as granules or beads. You can heat them up in boiling water and they will clump together in a mass. While still warm, you can mould the plastic before it sets hard in ten minutes or so.

[magpi.cc/polymorphicplastic](http://magpi.cc/polymorphicplastic)



33

**ALUMINIUM FOIL**

Available from convenience stores and supermarkets, foil can be used as a conductor in a circuit, as shielding to reduce electromagnetic interference, and also to reflect light and heat either away from or towards an area.

[magpi.cc/alufoil](http://magpi.cc/alufoil)

**TOOLS FOR CONNECTING ELECTRONICS****34 GPIO ruler/chart**

GPIO (general-purpose input/output) pins are the interface between your Raspberry Pi and electronic components. Until you learn which pin is which, you'll need a guide. There are several GPIO rulers and guides available to make life easier.

**35 Header connector**

For some projects, you may want to connect a HAT or pHAT to your Raspberry Pi, but not place it right on top of the board (or rear of Raspberry Pi 400). A female-to-male 40-way ribbon connector will enable you to extend the reach of the GPIO pins.

**36 Jumper wires**

Jumper wires connect Raspberry Pi GPIO pins to electronic components. Use them with a breadboard to prototype your circuit, or solder them directly to components. Be sure to get a variety of different colours to make your project easier to understand.

## TOOLS FOR SOLDERING

### 37 Desoldering kit

This equipment enables you to clean melted solder from components on a printed circuit board, allowing their removal or replacement.

### 38 Soldering station

A handy stand to place a soldering iron while it is still plugged in and hot. The sponge should be wet to clean the end of the iron.

### 39 Soldering iron

An absolute necessity for soldering or desoldering components onto printed circuit boards. For detailed work, an iron with a pointed end is best.

### 40 Third hand tool

Usually has a solid, heavy base with jointed arms with clips or holders at the end, and a magnifying glass for working on small components.



41

### MULTIMETER



You need to be able to measure current, resistance, and voltage in your circuits. Digital multimeters can cost as little as £10.

[magpi.cc/multimeter](http://magpi.cc/multimeter)



42

### GORILLA GLUE



Similar to superglue, but is supplied with a brush to apply. Sticks most materials and very good for 3D-printed parts. Usually takes around half an hour to dry.

[magpi.cc/plasticsheets](http://magpi.cc/plasticsheets)



43

### NUTS, BOLTS & SCREWS



Having a good range of sizes and shapes of nuts, bolts, and screws is absolutely necessary for making anything that you are not going to glue. Keep a jar full of spares.

44

### STICKY TAPE



For temporarily holding things in place or insulating wires. You can also use tape for wrapping handles of tools. Also good for removing cat fur from jumpers.

45

### BLU TACK



Usually used for keeping posters on walls, but can also be used for holding components in place while soldering. It also rubs out pencil marks if you don't have an eraser.

46

## POWER BANK / BATTERIES



Most maker projects need power, so it is a good idea to have a range of battery holders. Power banks for recharging phones can also be used for 5V supplies.

[magpi.cc/pimoronipower](http://magpi.cc/pimoronipower)



47

## 3D CREATION SOFTWARE



You may want to visualise your build before starting, and there are many 3D software packages to help you for free, like Blender; or with free trial versions, like SketchUp.

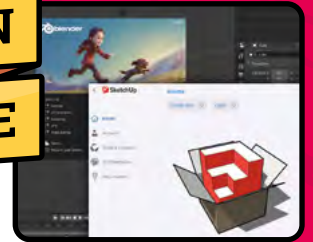

48

## FRITZING



When you have completed your project, you may want to document how you did it. Fritzing is a great program for laying out circuit diagrams.

[fritzing.org](http://fritzing.org)

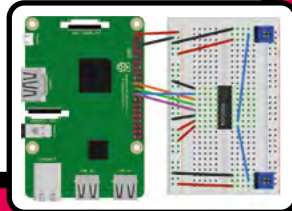

49

## PAPER CLIPS



Can be used to connect components, clean out small nooks and crannies, or hold materials in place. Apparently, you can pick locks with them too!

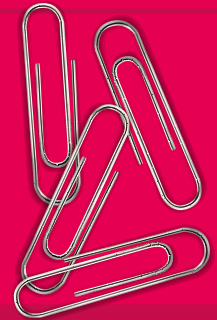

50

## DOCUMENTATION



One of the most important tools you will use for just about any maker project is reference material. Your Raspberry Pi may have come with some tips and hints about making, and many kits have worksheets and Frequently Asked Questions sections with them. Also, make best use of the online resources that detail other people's experiences: like Stack Overflow ([stackoverflow.com](http://stackoverflow.com)) for information about any technical subject; blogs such as [recantha.co.uk](http://recantha.co.uk) and [blog.pimoroni.com](http://blog.pimoroni.com); and of course the Raspberry Pi site ([rpf.io](http://rpf.io)) and magazines. If you're stuck getting something to work, it's likely someone else has had the same problem!

The Official Raspberry Pi site is full of tricks, tips, and plans for making all kinds of projects with your Raspberry Pi

Stack Overflow is a community of helpful people covering most technology topics

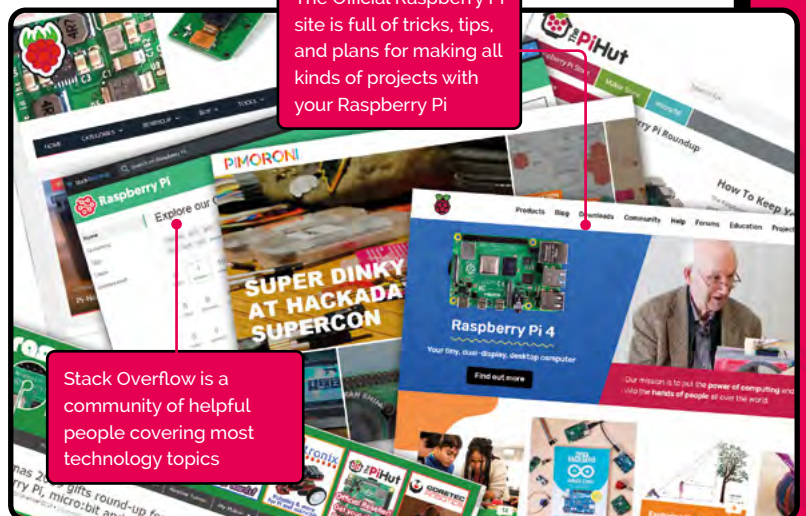

# Starter Electronics

## WITH RASPBERRY PI

If you bought a Raspberry Pi to learn how to make electronic gizmos, you're in for a treat. Here are some tips to get started. By **Mark Vanstone**

**O**ver the past few years, Raspberry Pi has gone from a small experimental computer to a very capable all-round system, while still retaining its small footprint. It has embedded itself in the hearts and minds of makers, coders, educators, inventors, and electro-artists around the world. Its flexibility

and computing power now makes it the go-to platform for embedded systems (like smart devices) and workhorse tasks such as controlling other network systems or even robotics. The range of tasks Raspberry Pi can achieve becomes wider all the time as the community creates new ways to use it.

### Gateway to the new frontier

Raspberry Pi has made a huge impact, not only on computer science education but also in the realm of makers and inventors. As well as being a really good-value computer, it gives the owner endless possibilities of connecting other electronics to it to produce useful gadgets and impressive demonstrations.

Raspberry Pi is your gateway to the new frontier of creative technology. If you can master the basics of how to

connect electronics to a Raspberry Pi, you can use the same techniques to start inventing your own gadgets and electronic tools. If these are your first steps into electronics, you have a very exciting journey ahead.

### Expand and experiment

In the early days of home computers, most models had expansion ports of one sort or another and, very often, upgrading them involved opening up the case and soldering new circuits, or at least plugging in chips into empty slots. These days, you are lucky if your home computer has USB connectors for accessories, and plugging in home-made contraptions is definitely not recommended.

Raspberry Pi is different because its design encourages the owner to plug in extra devices and even experiment with your own prototype circuits. Raspberry Pi has standard USB and Ethernet ports, a camera connector, WiFi, and HDMI video output. But the crowning glory of connectivity is its GPIO (general-purpose input/output) 40-pin header, which provides the tinkerer with access to the inner workings of Raspberry Pi. You can even write code to control electronics that are plugged in to the GPIO pins.

### What You'll Need

If you are lucky enough to have a local electronics or hobby store, you will no doubt be able to find all the electronic components we will talk about for a few pounds, dollars, or euros. Failing that, there are many fully stocked online outlets that can provide them. All you will need to start with is a breadboard, some jumper leads, a resistor (200 to 470  $\Omega$ ), and an LED.



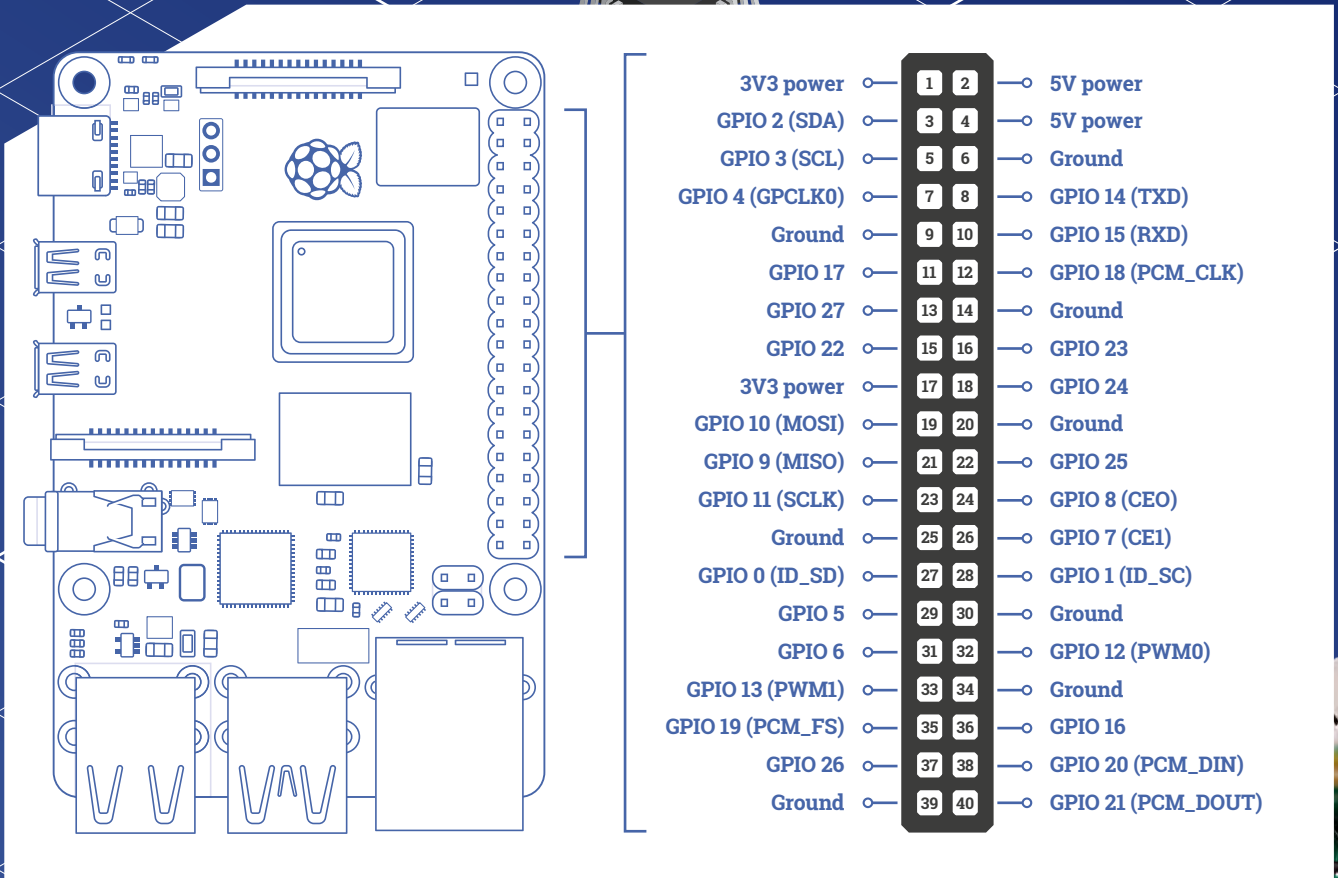

## GPIO pins

You can use Raspberry Pi's GPIO pins to pass electrical voltage to and from other components. Some of the pins have specific uses, such as power or ground connections, and others can be configured with software programs to send signals between Raspberry Pi and the rest of the circuit. Above is a breakdown of all the pins. Look carefully at physical pins 1 and 6: these will be the pins we use in our LED circuit later. Note that the pin numbers aren't the same as the GPIO numbers; for example, GPIO 2 is actually physical pin 3.

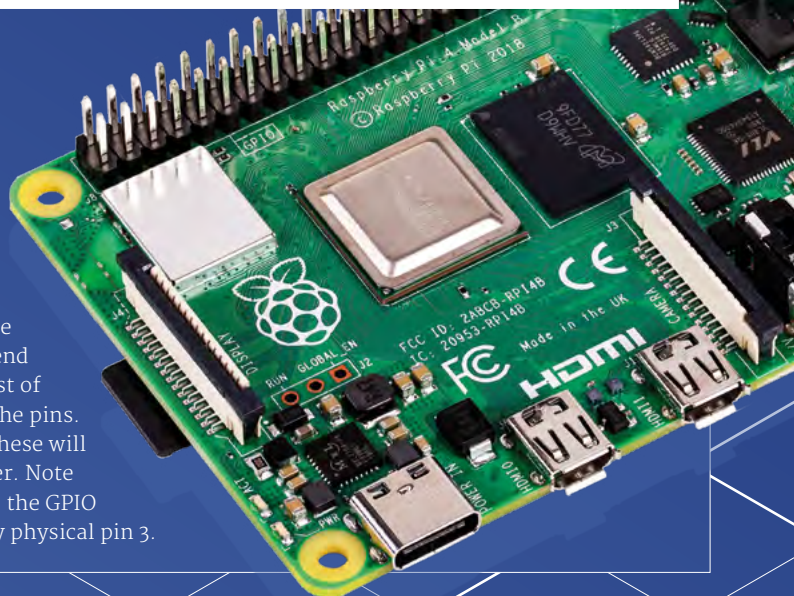

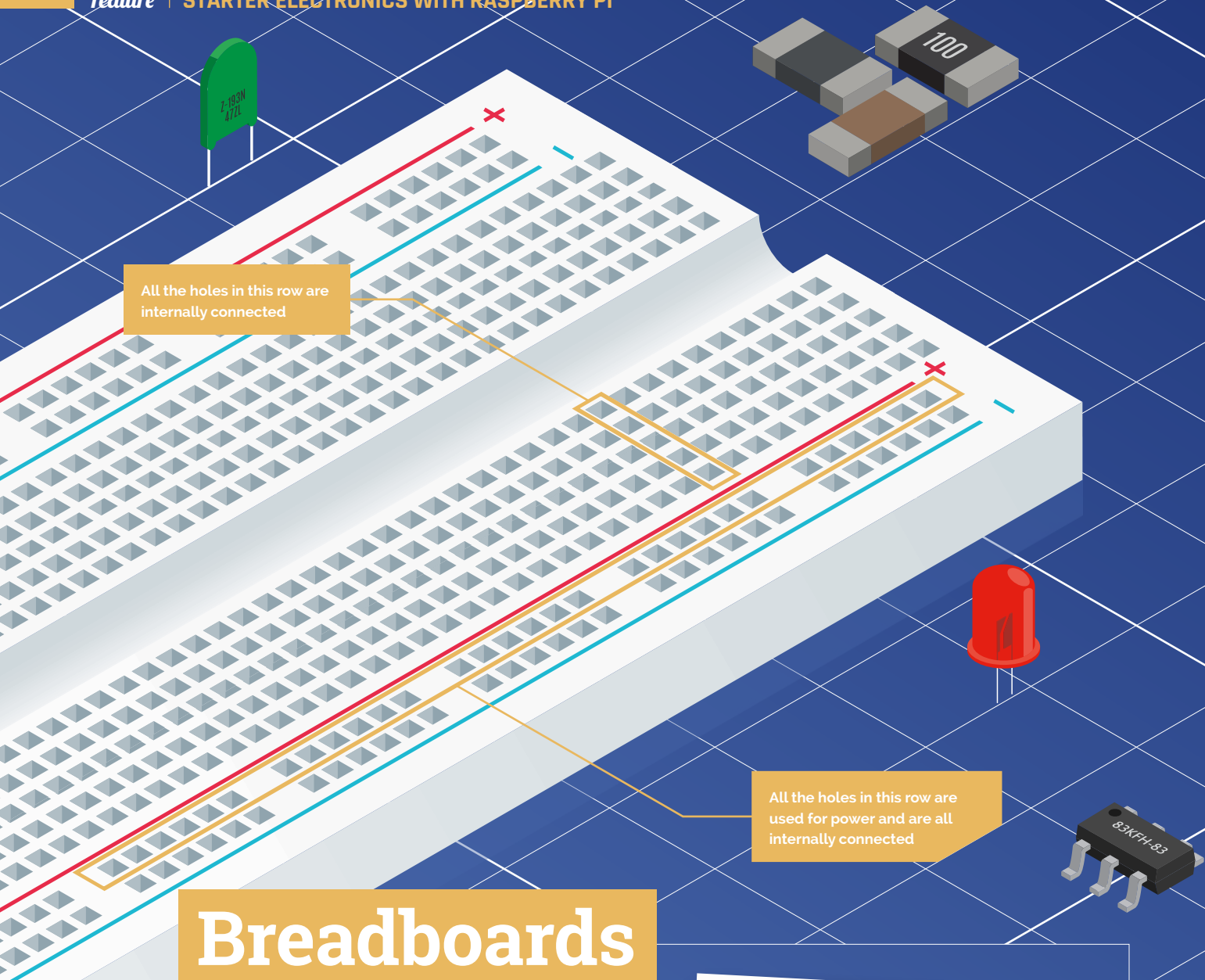

# Breadboards

Breadboards come in several different sizes and are made of plastic with a matrix of holes. In each hole is a connector which joins it to other holes on the same row.

The larger breadboards have two long rows of holes at the top and bottom. Sometimes called 'rails', these are generally used for power and ground connections. They are connected together as indicated on the diagram above.

The inner part of the breadboard has two sections of holes. Each section has rows of five holes which are connected as indicated on the diagram. The two halves of the breadboard are a mirror image of each other.

The break along the centre of the breadboard, often known as the 'gutter', enables mounting of integrated circuits (chips) with the legs of the chip going either side of the break.

See [magpi.cc/breadboard](http://magpi.cc/breadboard) for more info.

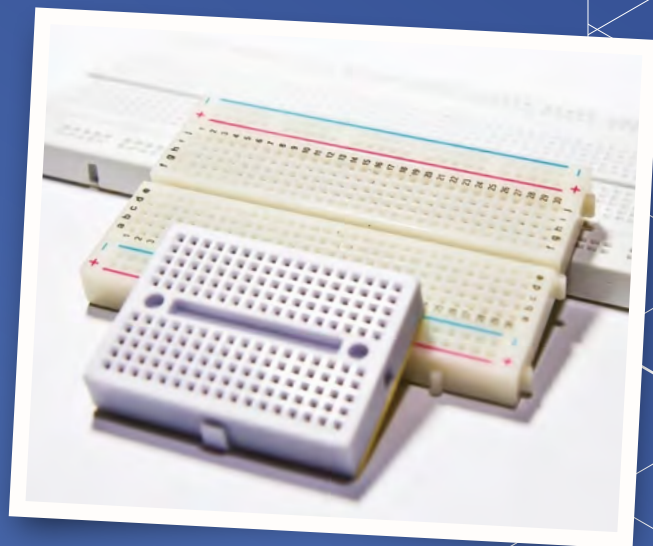

▲ Breadboards come in several sizes to enable prototyping of a wide variety of projects

# Make an LED light circuit

Let's dive into some practical circuit making with an example of how we can use the GPIO pins on the Raspberry Pi to make a circuit. We will go into the details of what the components are in a little while, but let's look at what a circuit actually looks like on a diagram. We will use the power source of Raspberry Pi to light an LED (light-emitting diode). When electricity is passed through an LED, it glows. We will also need a resistor in our circuit to limit the amount of electricity that goes through the LED. If too much electricity flows, the LED may burn out.



**WARNING:** When connecting components to the Raspberry Pi, it is always best to have the power off and unplugged in case you make a mistake with your wiring.

## 01 Turn off the power

Make sure you have shut down your Raspberry Pi and unplugged its power cable. Plugging in jumper leads while switched on may

be tolerated by Raspberry Pi, but in some cases it can cause a system crash or even damage to the hardware.

## 02 Build the circuit

Connect the components as shown in the wiring diagram below. Take careful note of the GPIO pins that you are connecting. The precise positioning of components on the breadboard is not so important, but make sure that the LED's longer (positive) leg is connected to the 3V3 power pin via the jumper lead.

## 03 Light it up

When you are sure that you have connected everything correctly, plug in your Raspberry Pi. After a short time, the LED should light up as soon as the power GPIO pins are energised. If the LED does not light up, try connecting it the other way around, as it will only work one way.

## You'll need

To build this simple LED circuit you need the following:

- ▶ Breadboard
- ▶ LED
- ▶ 470 resistor
- ▶ 2 × male-to-female jumper wires

Everything can be found in the CamJam EduKit #1 (£5) [magpi.cc/edukit](http://magpi.cc/edukit)

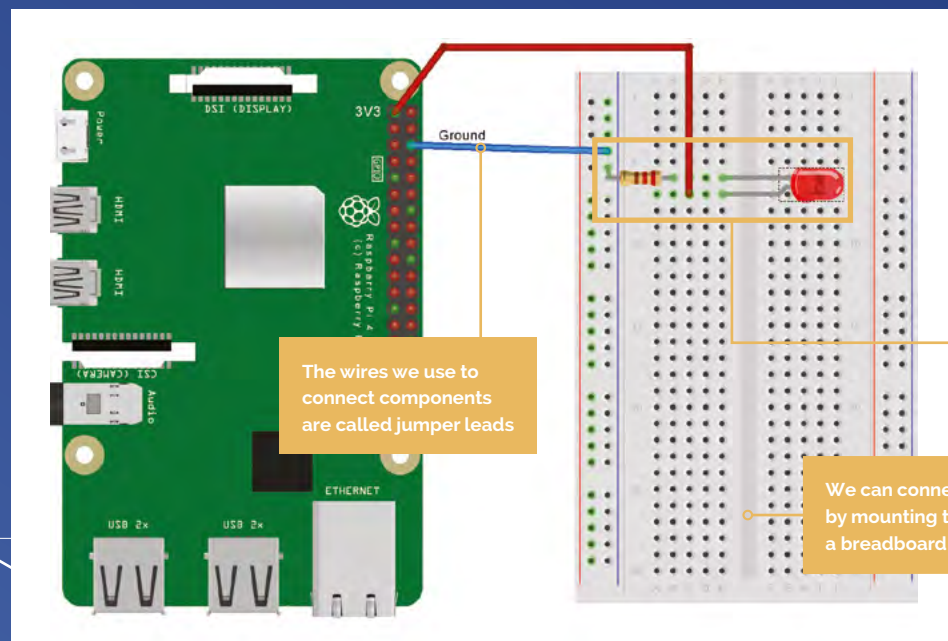

# Basic prototyping components

## Jumper leads

These connect your components to the Raspberry Pi. They can either have male or female end connectors (you need female for the GPIO pins) and it's a good idea to have a mix of both.

## LED

Light-emitting diodes come in various colours. They glow when electricity flows through them. Because they are a diode, the current will only flow in one direction, so make sure that it is connected the right way round: the longer leg is the positive one and should be connected to the power (or GPIO output) pin. Always use a resistor in series with LEDs, otherwise they are likely to draw more current than they can handle and burn out.



## Switch

Switches make and break circuits. When connected in series in a circuit, a switch will allow or stop the flow of electricity. You can get switches that stay in the position in which they are set, or ones that you need to keep your finger on to keep the circuit connected.

## Speaker

Speakers can be huge and very loud or they can be very small – small enough to fit on a breadboard. These small speakers are called piezoelectric and are great for making robotic noises, but not much good for hi-fi music applications.

## Capacitor

Capacitors store and release electrical charge. They can be used to even out the electrical current or provide a greater flow for a short time. Be careful when using capacitors, as they can still hold charge after the circuit has been disconnected.



## Resistor

Resistors are available in various formats, but this is the most common format for prototyping.

The coloured rings around the resistor indicate how much resistance it provides. For more details about how to read resistor values, see [magpi.cc/64](http://magpi.cc/64).

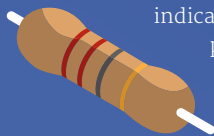

## Transistor

Transistors are used in many types of circuits. They can be used either as an amplifier, which means that a small current goes in but a bigger current comes out, or as an electrical switch to change the amount of electricity flowing through circuit. A transistor has three legs or connectors: the emitter, the collector, and the base.

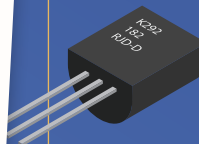

## Servo

Servos are used a lot in robotics for making things move. They can be connected directly to Raspberry Pi via the GPIO pins, but there are also

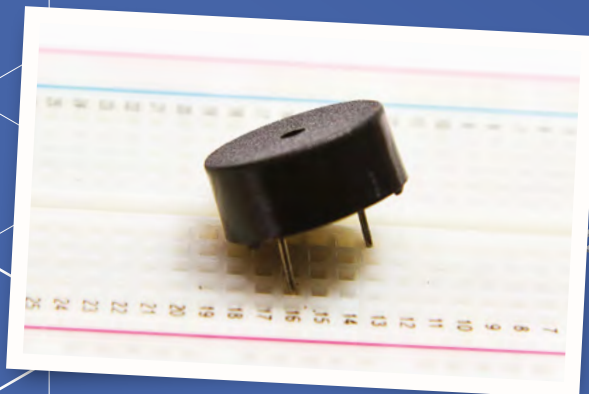

▲ A small piezoelectric speaker is good for making simple noises

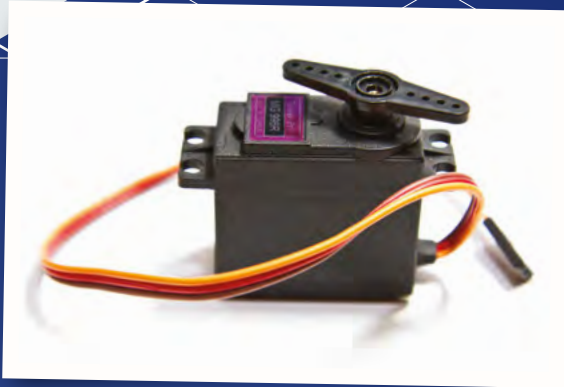

▲ A servo is a special type of motor that allows for precise control of its rotational (or linear) position

extra plug-in boards (or HATs) that make it easier to connect many servos and control them more easily. Normally we use digital servos which use PWM (pulse-width modulation) signals to turn the armature on the servo from one position to another.

### Batteries

Batteries can be all kinds of shapes and sizes, but for simple electronics projects you will normally be using 1.5V AA or AAA type cylindrical batteries or 9V square ones. Make sure you always have some spares or perhaps you may want to use rechargeable ones. Rechargeable batteries cost more, but can be used over and over. Make sure you connect batteries correctly and never directly connect the two contacts together, as even small voltage batteries can get very hot or even explode if 'short-circuited'.

### Potentiometer

Potentiometers are variable resistors and usually have a twisting knob or a slider to change the resistance. They have three connectors and can be used as game controllers or volume controls. Be careful if you are using a potentiometer instead of a resistor in your LED circuit: if you turn the resistance right down to zero, you may burn out your LED.

▶ A potentiometer produces an analogue output that may be converted to digital by an ADC

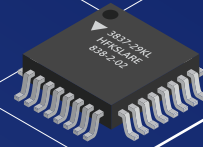
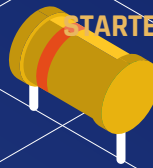
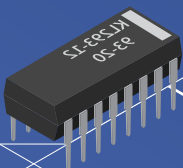

# Prototyping using kits



### CamJam EduKits

There are currently three CamJam EduKits available: a starter kit with all the components and more to make our LED circuit, a sensors kit to explore getting input from the world around you, and a robotics kit with wheels and motors to make your Raspberry Pi into a robot. [magpi.cc/camjamkits](http://magpi.cc/camjamkits)

### Adafruit Parts Pal

The Adafruit Parts Pal is a more comprehensive kit. It contains many popular components and prototyping parts, including LEDs, resistors, cables, sensors, and mechanical parts. [magpi.cc/partspal](http://magpi.cc/partspal)



### Elecrow CrowPi Educational Kit

This is the daddy of all-in-one experimentation kits. There are chips and sensors, dials, speakers, numeric displays, and even a 7-inch HDMI touchscreen. It was developed with a Kickstarter appeal and is available directly from Elecrow in the US, or Amazon in the UK. [magpi.cc/crowpi](http://magpi.cc/crowpi)



# Getting started with electronics: LEDs and switches

MAKER

**Simon Monk**

Simon divides his time between writing and designing products for MonkMakes Ltd. Some of his better-known books include *Programming Raspberry Pi* (TAB) and *The Raspberry Pi Cookbook* (O'Reilly).

[simonmonk.org](http://simonmonk.org)

## You'll Need

- ▶ The Mu Python editor [codewith.mu](http://codewith.mu)
- ▶ Solderless breadboard
- ▶ 5 × female-to-male jumper wires
- ▶ Male-to-male jumper wire
- ▶ 2 × red LEDs
- ▶ RGB common cathode LED
- ▶ 3 × 470 resistors
- ▶ 2 × tactile push-buttons

These components are all included in a MonkMakes kit: [magpi.cc/pibox1](http://magpi.cc/pibox1)

Use Raspberry Pi's GPIO pins to build two simple electronic projects. By **Simon Monk**

In this tutorial, you will learn how to make two simple projects that use LEDs and push-button switches that are controlled by a Python program running on your Raspberry Pi. The first project uses an RGB (red, green, blue) LED to interface to the popular Cheerlights project. Cheerlights ([cheerlights.com](http://cheerlights.com)) allows users all over the internet to set each other's LEDs to different colours just by tweeting.

The second project is a reaction timer using LEDs and push-buttons to test the speed of your reactions.

## Set up some Cheerlights

### 01 Install the code

Before fetching the code from the internet, you should run Mu, which you will find in the Programming section of your main menu. If it's not there, update your system to the latest version of Raspberry Pi OS ([magpi.cc/rpiosupdate](http://magpi.cc/rpiosupdate)).

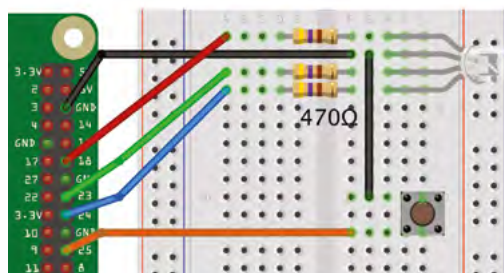

▲ Figure 1 The Cheerlights wiring diagram

Running Mu ensures that the `mu_code` directory is created, into which we will now copy the program code. To do this, open a Terminal window and run the commands:

```
wget http://monkmakes.com/downloads/pb1.sh
sh pb1.sh
```

This will copy the programs used in this tutorial into the `mu_code` directory, along with some other programs.

“ Push the component legs into the breadboard at the positions shown ”

### 02 Place components onto breadboard

Using **Figure 1** as a reference, push the component legs into the breadboard at the positions shown. Bend the resistor legs so that they fit into the holes.

Each hole in a row of five holes on the breadboard is connected together under the plastic. So, it's very important to get the right row for your component leg.

The resistors can go either way around, but the RGB LED must go the right way around, with its longest leg to row 2 (the one without a resistor). The push-button used in the MonkMakes kit has just two legs, but many similar buttons have four legs. If you have a four-legged version, put it on the breadboard in the orientation that leaves

# Attaching electronics to a Raspberry Pi

A GPIO template makes it easier to find the right pin when you are connecting things together

A solderless breadboard is used to hold the electronic components and connect them together

just one free row between the pins. You will also need to place a linking male-to-male jumper wire between rows 2 and 10.

## 03 Connect breadboard to Raspberry Pi

Again, using **Figure 1** as a reference, connect the GPIO pins on the Raspberry Pi to the breadboard. A GPIO template will make this easier – if you don't have one, you will need to carefully count the pin positions. It doesn't matter what colour jumper leads you use, but if you stick to the colours used in the diagram, it's easier to check that your wiring is correct.

## 04 Running the program

To use this project, your Raspberry Pi must be connected to the internet. Load and run the program **04\_cheerlights.py** using Mu. After a few seconds, the LED will automatically set itself to the current Cheerlights colour, checking every ten seconds. Pressing the button will turn the LED off until the Cheerlights colour changes.

Jumper wires with sockets on one end and pins on the other are used to connect the GPIO (general-purpose input/output) pins of Raspberry Pi to the breadboard

An LED can be turned on and off within a Python program using a GPIO pin acting as an output

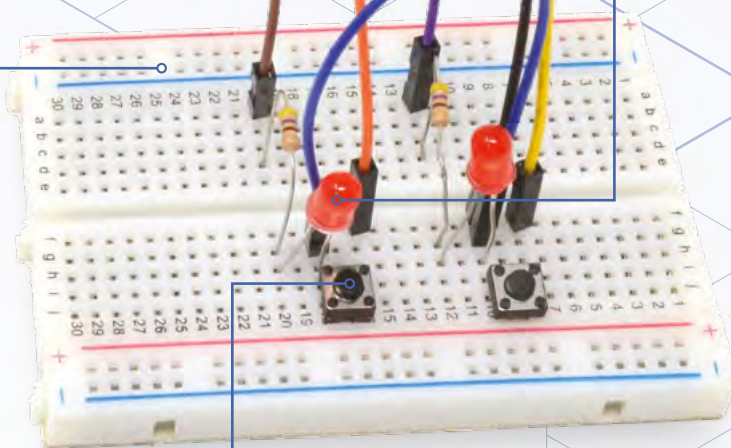

Your programs can tell that a switch has been pressed by connecting a switch to a GPIO pin and reading that GPIO pin as an input

## 05 Tweet a new colour

Now that your Raspberry Pi is looking out for changes to the Cheerlights colour, anyone can simply send a tweet mentioning **@cheerlights** and the name of a colour; your LED should then change to that colour. You can test this out by sending a tweet such as '@cheerlights red' and after a few seconds your LED should change colour. You will find that after a few minutes, the colour probably changes as someone else sets the Cheerlights colour.



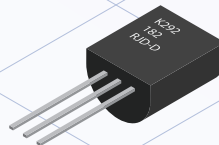

- 1 The RGB LED is actually three LEDs in one: red, green, and blue. Changing the power going to each LED (controlled by a separate GPIO pin) changes the overall colour.
- 2 GPIO 24 acts as an output. Current flows out of GPIO 24, through the resistor, through the blue LED and back to Raspberry Pi's GND (ground connection).
- 3 An LED will draw as much current as it can, so each LED needs a resistor to reduce the current, protecting the LED and/or the GPIO pin of Raspberry Pi.
- 4 When the switch is pressed, it connects GPIO pin 25 (acting as an input) to GND (0V).
- 5 An internal pull-up resistor keeps GPIO 25 at 3.3V until the switch is pressed – that overrides the effect of the resistor, making GPIO 25 0V. Without this, GPIO 25 would be a floating input liable to false triggering from electrical noise.

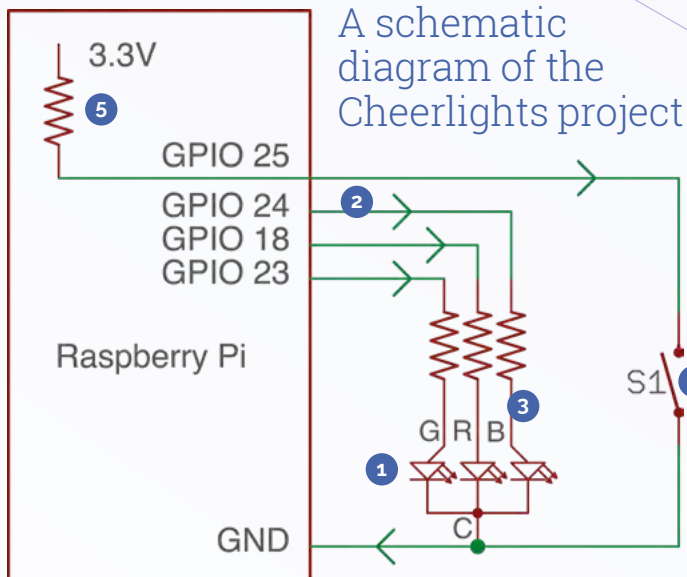

A schematic diagram of the Cheerlights project

## Build a reaction timer

### 01 Dismantle the breadboard

First, pull the jumper leads off the GPIO pins on the Raspberry Pi and then pull all the components and wires off the breadboard so that it is ready for the next project.

### 02 Place the components

This time, using **Figure 2** as a guide, push all the component legs into the breadboard at the positions shown. It doesn't matter which way round the resistors and buttons go, but the LEDs have a positive and negative end, so must go the correct way around. The positive end of the LED (marked '+' on the diagram) is the longer leg and this should go to the same row on the breadboard as the resistor.

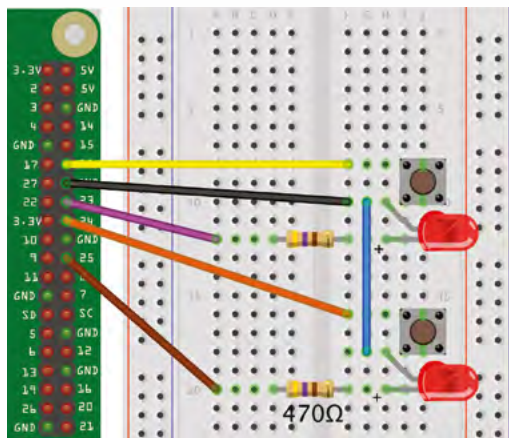

▲ **Figure 2** The Reaction Timer wiring diagram

```
Running: 07_reactions.py
Press the button next to the LED that lights up
right
Time: 465 milliseconds
Press the button next to the LED that lights up
left
Time: 305 milliseconds
Press the button next to the LED that lights up
left
```

▲ **Figure 3** The Reaction Timer results in the Mu console

### 03 Connect breadboard to Raspberry Pi

Using **Figure 2** as a reference, connect the GPIO pins on the Raspberry Pi to the breadboard using five female-to-male jumper wires.

### 04 Running the program

To use the reaction timer, load and run the program **07\_reactions.py** in Mu. When the program starts, you will notice that the bottom part of the Mu window shows a message telling you to 'Press the button next to the LED that lights up' (**Figure 3**).

After a random amount of time, one of the LEDs will light, and you should press the button next to that LED as quickly as possible. You will then get a message telling you how many milliseconds you took to press the button.

The code includes checks to make sure you don't try to cheat by pressing both buttons at once, or pressing the buttons before an LED has lit. [M](#)



## 04\_cheerlights.py

DOWNLOAD  
THE FULL CODE:



[magpi.cc/pibox1git](https://magpi.cc/pibox1git)

► Language: Python 3

```
001. # 04_cheerlights.py
002. # From the code for the Box 1 kit for the Raspberry
003. Pi by MonkMakes.com
004.
005. from gpiozero import Button, RGBLED
006. from colorzero import Color
007. import time, requests
008.
009. update_period = 10 # seconds
010. led = RGBLED(red=18, green=23, blue=24)
011. button = Button(25)
012.
013. cheerlights_url = "http://api.thingspeak.com/
014. channels/1417/field/2/last.txt"
015. old_color = None
016.
017. def pressed():
018.     led.color = Color(0, 0, 0) # LED off
019.     button.when_pressed = pressed
020.
021.     while True:
022.         try:
023.             cheerlights = requests.get(cheerlights_url)
024.             color = cheerlights.content
025.             # the color as text
026.             if color != old_color:
027.                 led.color = Color(color)
028.                 # the color as an object
029.                 old_color = color
030.             except Exception as e:
031.                 print(e)
032.                 time.sleep(update_period)
033.             # don't flood the web service
```

## 07\_reactions.py

► Language: Python 3

```
001. # 07_reactions.py
002. # From the code for the Box 1 kit for the Raspberry
003. Pi by MonkMakes.com
004.
005. from gpiozero import LED, Button
006. import time, random
007.
008. left_led = LED(25)
009. right_led = LED(23)
010. left_switch = Button(24)
011. right_switch = Button(18)
012.
013. # find which buttons pressed 0 means neither,
014. # -1=both, 2=right, 1=left
015. def key_pressed():
016.     # if button is pressed is_pressed will report
017.     # false for that input
018.     if left_switch.is_pressed and
019.     right_switch.is_pressed:
020.         return -1
021.     if not left_switch.is_pressed and not
022.     right_switch.is_pressed:
023.         return 0
024.     if not right_switch.is_pressed and
025.     left_switch.is_pressed:
026.         return 1
027.     if right_switch.is_pressed and not
028.     left_switch.is_pressed:
029.         return 2
030.
031. while True:
032.     left_led.off()
033.     right_led.off()
034.     print(
035.         "Press the button next to the LED that lights up")
036.     delay = random.randint(3, 7)
037.     # random delay of 3 to 7 seconds
038.     led = random.randint(1, 2)
039.     # random led left=1, right=2
040.     time.sleep(delay)
041.     if (color == 1):
042.         print("left")
043.         left_led.on()
044.     else:
045.         print("right")
046.         right_led.on()
047.     t1 = time.time()
048.     while not key_pressed():
049.         pass
050.     t2 = time.time()
051.     if key_pressed() != led :
052.         # check the correct button was pressed
053.         print("WRONG BUTTON")
054.     else:
055.         # display the response time
056.         print("Time: " + str(int((t2 - t1) * 1000))
057.             + " milliseconds")
```

# BUILD THE ULTIMATE MAGIC MIRROR

Magic mirrors. How do they work? Are they really magic? Are they only for the advanced maker?

**PJ Evans** goes through the looking glass

**M**agic mirrors have to be one of the most popular projects out there. Initially created by combining old laptops and semi-reflective observation glass, they appear as normal mirrors but with text and images that appear to float in mid-air. The information displayed is typically what you need as you're preparing to leave the house: weather, news headlines, and transit information. Although they come across as advanced builds, the community behind the projects have made significant advances in making magic mirrors accessible to all. Let's take a look at one of these makers and then have a go at building our own mirror.

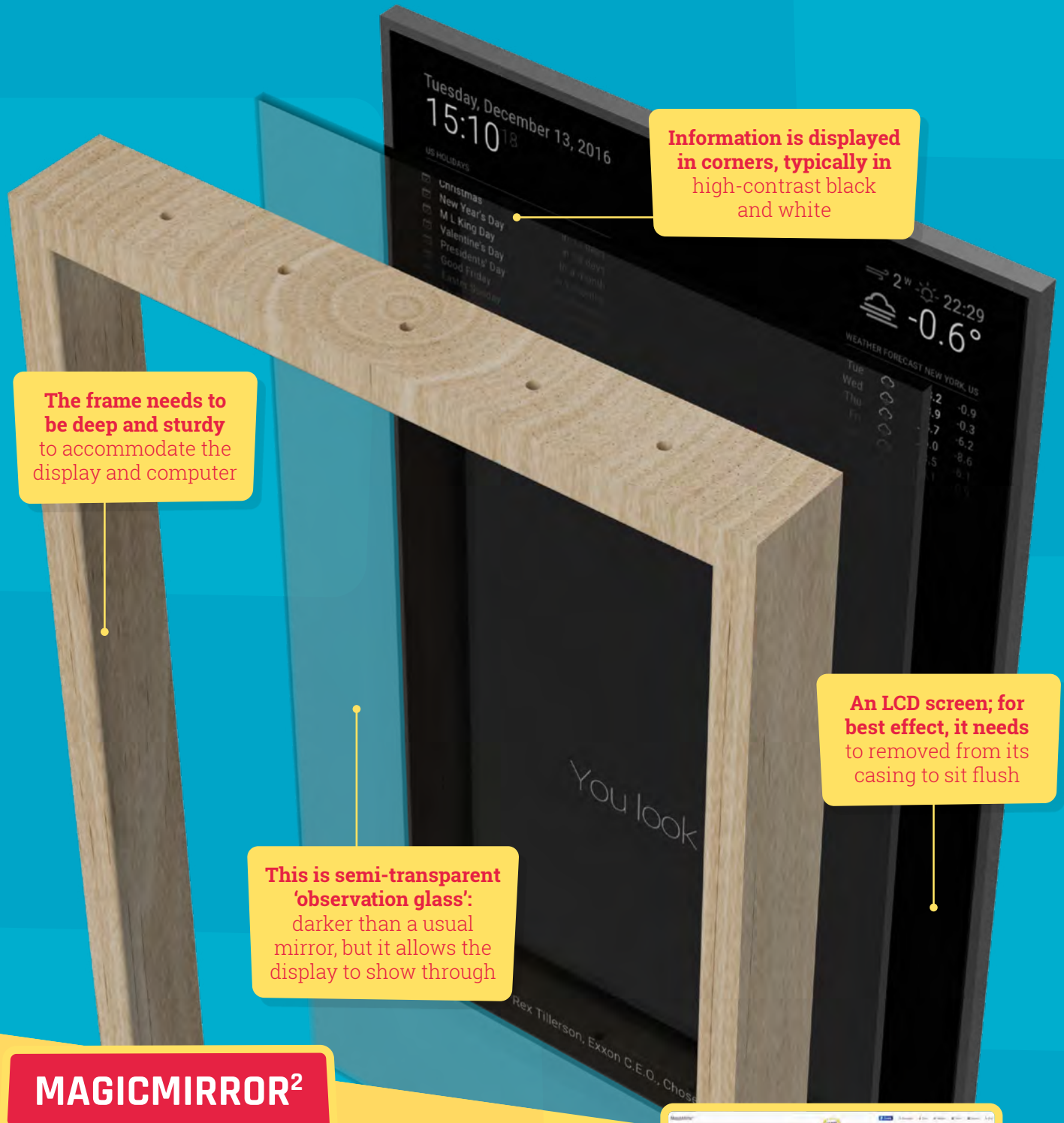

Information is displayed in corners, typically in high-contrast black and white

The frame needs to be deep and sturdy to accommodate the display and computer

An LCD screen; for best effect, it needs to be removed from its casing to sit flush

This is semi-transparent 'observation glass': darker than a usual mirror, but it allows the display to show through

## MAGICMIRROR<sup>2</sup>

Creating a good magic mirror requires experience in many disciplines including carpentry, electronics, programming, and graphic design. Fortunately, the team at MagicMirror<sup>2</sup>, headed by Michael Teeuw (see *The MagPi* issue 54, [magpi.cc/54](http://magpi.cc/54)), have not only compiled tutorials and fostered a great community, they've also built their own open-source application. This modular

system takes away all the programming and design pain. Best of all, you can expand the capabilities of your mirror through the hundreds of community plug-ins available and, if you wish, you can write your own. It's no wonder it won the number one slot in our best projects feature for issue 50.

[magicmirror.builders](http://magicmirror.builders)



# Assembling a simple magic mirror

Would you like a magic mirror, but don't fancy all that carpentry? Here's a first project to ease you in without having to reach for the band-saw

## You'll Need

- ▶ Ikea Ribba 18x24 picture frame [magpi.cc/ribba](http://magpi.cc/ribba)
- ▶ Official Raspberry Pi 7" Touchscreen [magpi.cc/touchscreen](http://magpi.cc/touchscreen)
- ▶ A5 observation mirror [magpi.cc/a5mirror](http://magpi.cc/a5mirror)
- ▶ Gaffer or duct tape
- ▶ Velcro or foam sticky pads

## Tip! Not for Zero

A Raspberry Pi Zero would seem ideal for this project, but MagicMirror<sup>2</sup> is incompatible with that model and the original Raspberry Pi 1.

- ▶ The Ikea Ribba range is perfect for a starter project like this thanks to having unusually deep frames and a wide variety of sizes

**T**here have been some impressive magic mirror projects as makers around the globe challenge each other to improve on previous designs. Although the results are undoubtedly impressive, it can make the hobby look a little daunting to the beginner, especially if you don't have access to the necessary equipment to build a custom frame. In this tutorial, we'll assemble a simple magic mirror using off-the-shelf parts. This can be built in an afternoon and is a great way to find out whether you want to take it to the next step and get working on something a bit bigger.

## 01 Prepare the frame

To create our magic mirror, we will create a 'sandwich' of the frame, a piece of observation mirror acrylic, and the screen. It's vital that all these are kept as clean as possible during assembly as any dust will get trapped and leave an irritating mark on your lovely mirror. Unpack the frame, remove the mount, and then remove the plastic clear sheet. You'll need to carefully peel back the



two protective layers and then replace the clear sheet in the frame. This is statically charged and will start to attract dust, so lots of cleaning is required. Return the mount to the frame.

## 02 Mount the mirror

The big 'trick' of a magic mirror is the use of two-way material, also known as 'observation glass'. This material is the same that is used in police interview rooms and as privacy screening. It's only semi-reflective, so the output from your screen can be seen 'through' the glass but it's still effective as a mirror (if a little darker than a regular mirror). This material is cheapest when bought by the roll, so it's ideal for custom-build or larger mirror projects. Ours is a £5 A5 acrylic sheet. Remove the protective sheeting and place in the frame, making sure it covers the open area. Secure with sticky tape.

“ The big 'trick' of a magic mirror is the use of two-way material, also known as 'observation glass' ”

## 03 Add the screen

We're using the official 7-inch touchscreen for this project to make power requirements easier; we only need one cable to drive both Raspberry Pi and the display. It also happens to be a perfect size for this project. The touchscreen needs to be carefully placed so it's in parallel with the frame and central. Secure with sticky tape.

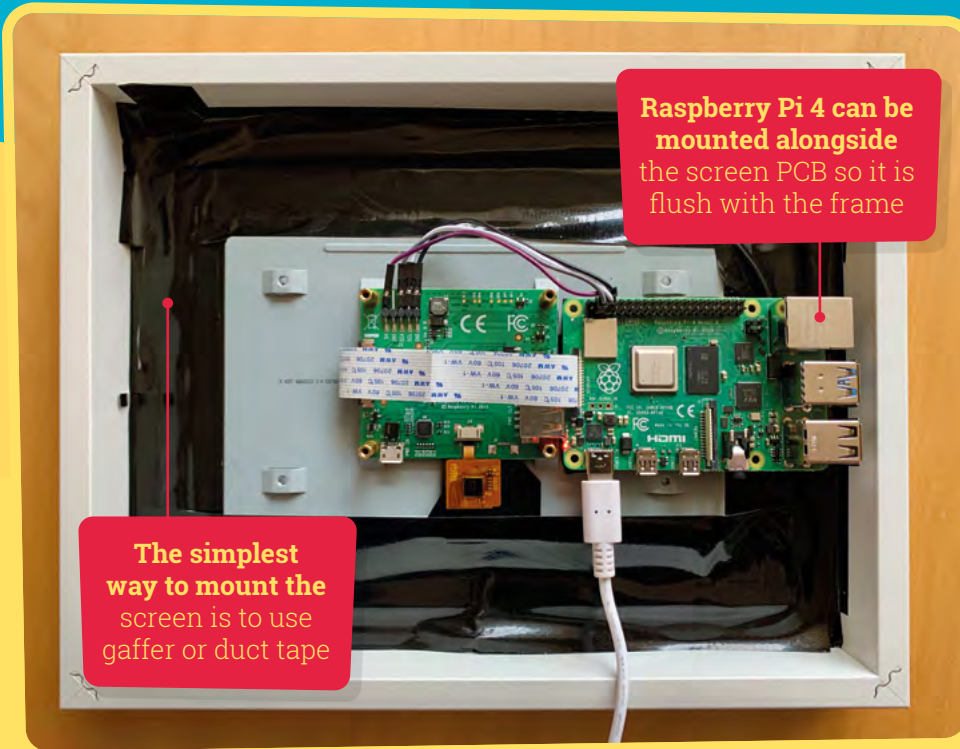

Raspberry Pi 4 can be mounted alongside the screen PCB so it is flush with the frame

The simplest way to mount the screen is to use gaffer or duct tape

**PROFESSIONAL BUILDS**

We've created a simple project for you here that requires no cutting or mains electricity. However, it would be remiss of us not to admire the work of those who have dedicated hours and hours to making the ultimate magic mirror. One of those is MagicMirror<sup>2</sup> creator Michael Teeuw, who has created several mirrors completely from scratch, building his own frames and carefully mounting large monitors – all powered by Raspberry Pi computers, of course! The great thing about magic mirrors is you can start small and work up to masterpieces like this, learning as you go.

[michaelteww.nl](http://michaelteww.nl)

**04 Secure in place**

The combined weight of a Raspberry Pi computer and the touchscreen doesn't come to much, so rather than getting into complicated mounting solutions, we will apply generous amounts of gaffer (or duct) tape to hold everything in place. This is of course a very lo-fi solution – if you want to go for something more refined, you can consider making use of the mounting points on the screen that can be used with horizontal or vertical bars to attach to the inner edge of the frame. Check for any trapped dust or marks in our 'sandwich' before proceeding.

**05 Just add Raspberry Pi**

Normally, you would mount a Raspberry Pi computer on top of the screen's PCB on the provided standoffs. If you want to mount your completed mirror on the wall, this poses a problem, as the computer now sits quite a way proud of the frame. Your options are: 1) don't care (not advisable), 2) buy a second frame and fix it to the original to double its depth, or 3) mount the Raspberry Pi computer on the side. We've gone with option three and it just fits, even with the supplied display cable. Make sure you line the

back of the screen with insulation tape to avoid any electrical shorts and secure in place with a Velcro pad to allow for future access to the microSD card.

**06 Check and test**

With a microSD card with Raspberry Pi OS installed, mount the Raspberry Pi 4 into place. Check the display ribbon cable hasn't been stretched too much and the four jumper cables that connect the display to the GPIO are in the correct position. You should now be able to boot and see the Raspberry Pi OS boot sequence through the display. It will probably look disappointingly dull. Don't worry, we'll address that in the next tutorial. If everything is free of dust, secured, and the display is working, shut everything down (you may need to connect a keyboard and mouse to do this).



**Tip!**  
Larger screen? Better mount  
We've chosen gaffer tape, as the official screen is very light. This would be a terrible idea for a 'full-size' monitor.

# Setting up your Magic Mirror

Check you're looking good and fill your brain with useful information with your new frame and MagicMirror<sup>2</sup>

## You'll Need

- ▶ Magic mirror (see previous tutorial)

## Tip! Editing JSON

MagicMirror<sup>2</sup>'s configuration file is in JSON (JavaScript Object Notation). It is a powerful but unforgiving format, so be careful when editing it.

- ▼ A clearer view of the screen. You can customise all these panels and place them wherever you like

**S**o far, we've got a frame built and ready to go. Next, we'll look at how to set up your Raspberry Pi computer to run MagicMirror<sup>2</sup>, a dedicated application for creating magic mirror displays that takes all the hard work out of the software side of this project. MagicMirror<sup>2</sup> has been authored by Michael Teeuw, who created the amazing mirror in the beginning of this feature. Not only does the software provide a plug-in system to control what's displayed, it also configures your Raspberry Pi computer for optimal performance as a mirror. That said, there are a few things to do, so let's get started.

## 01 First boot-up

In the final step of the previous tutorial, we checked that Raspberry Pi would boot correctly in its new home. If you haven't done this already, prepare a microSD card with an image of Raspberry Pi OS (not the Lite version, as we need the desktop). If you have access to a second identical Raspberry Pi computer, it might be easier to use that, as the display will be easier

to see, then swap the microSD card when you're done. Go through the first-run wizard that helps you configure WiFi and updates all your software to the latest version.

## 02 Make access easier

Every time you want to make a configuration change, it's going to be a nuisance to take the mirror down off the wall, locate a keyboard, mouse, and possibly monitor to make a simple edit. Instead we can use VNC and SSH to make life easier. VNC allows us to access the desktop remotely via VNC Viewer, which is available for many different platforms. SSH is similar, but for the command line. To enable both of these, open the desktop menu (the raspberry icon) and click on Preferences, then Raspberry Pi Configuration. When its window appears, click the Interfaces tab and ensure VNC and SSH are enabled, but don't close the window just yet.

## 03 Set your host name

To avoid your magic mirror bumping into any other Raspberry Pi computers you may have on your network, we strongly recommend setting the computer's host name (the name it is known as on the network) to something unique. Again, you can set this in the Raspberry Pi Configuration tool. On the System tab, choose an appropriate name such as 'magicmirror' (lower case, no spaces or special characters) and click OK. A reboot will be required for this to take effect. Once done, you can point your VNC Viewer or SSH client to **magicmirror.local** to gain remote access.



MagicMirror<sup>2</sup> defaults to a high-contrast black and white display which works well with the reduced visibility



Your maker. Photographing a magic mirror presents unique challenges

## GREAT USES FOR YOUR MAGIC MIRROR

We're going to be looking at uses for your magic mirror in upcoming issues of *The MagPi*. In the meantime, let's whet your appetite with some of the cool things you can do. The link below goes to the exhaustive list of add-ons available for MagicMirror<sup>2</sup>. They cover anything from calendar integration to up-to-the-minute finance information. Need to know how many minutes until the next bus? No problem. Some go beyond the display itself, offering voice control via Alexa and Google Home. How about a Pokémon of the day or video live stream? Can't find what you need? If you know some JavaScript, it is surprisingly easy to write your own modules.

[magpi.cc/mirrormodules](http://magpi.cc/mirrormodules)

### Tip! Restarting MagicMirror<sup>2</sup>

If you have made a configuration change, you can restart without having to reboot by typing this at the command line: `pm2 restart MagicMirror`

## 04 Install MagicMirror<sup>2</sup>

Now the fun part. MagicMirror<sup>2</sup> is an Electron app: a web app wrapped up in its own browser. Installing it manually is complex, but Michael and the team have provided an elegant script that automates the entire process. Get to a command-line prompt by using Terminal or an SSH client and carefully enter the following command:

```
bash -c "$(curl -sL
https://raw.githubusercontent.com/MichMich/
MagicMirror/master/installers/raspberry.sh)"
```

(For more detailed instructions, see [magpi.cc/magicmirror](http://magpi.cc/magicmirror).)

The script will now install Node (the programming environment that runs MagicMirror<sup>2</sup>), Electron, and the app itself.

## 05 Configuring MagicMirror<sup>2</sup>

During installation you'll see a lot of text fly by the screen, along with a couple of warnings that can be safely ignored. You will be asked at one point whether you want to install and enable pm2. Process Manager 2 (pm2) is an application that simplifies the running of Node apps (or anything else), starting things at boot or

“ MagicMirror<sup>2</sup> is now installed and you should be able to see the display ”

automatically restarting apps when they crash. If you reply 'yes', pm2 will start MagicMirror<sup>2</sup> immediately on boot. You will also be asked if you want to start the app right away. If you're eager to see it in action, say yes.

## 06 Initial configuration

MagicMirror<sup>2</sup> is now installed and you should be able to see the display on your mirror. The installation process has tweaked a lot of settings to improve the display quality and has disabled things such as screen sleeping. You can customise what is displayed on screen and its position by having a look at the configuration file located at `~/MagicMirror/config/config.js`. If you're finding the screen too crowded, you can tweak the layout by changing the value of 'zoom'. We found 0.6 worked well for the Raspberry Pi touchscreen. We'll look into more of these settings next time. For now, go and get a hook and put up your new fancy magic mirror!

# Voice Control for your Magic Mirror

Mirror, mirror on the wall, who's the fairest of them all? Whaddaya mean, 'Alexa'?

## 01 Get the right kit

Reliable voice recognition requires a good-quality microphone. If you want to use services such as Alexa, you may want to add an amplified speaker too. The easiest options are widely available USB sound devices, many of which are compatible with Raspberry Pi.



▶ The Snowflake mic is a great choice

## 02 Choose your solution

MagicMirror<sup>2</sup>'s plug-in system and amazing community means you have a wide choice of voice assistants with different purposes and capabilities. See [magpi.cc/mirrorvoice](http://magpi.cc/mirrorvoice) for the current list of modules.



## 03 Install your module

A good starting module is one called MMM-awesome-alex. Follow the instructions at [awesome-alex.js.org](http://awesome-alex.js.org) to install the module, then add your microphone and speaker to your mirror build, being careful not to 'muffle' the mic. Now your mirror is Alexa-enabled! 



▲ Old monitors and TVs also make great mirror options, and you can still easily add voice control to them!



THE OFFICIAL RASPBERRY PI

# CAMERA GUIDE

- Take pictures and shoot video with your Raspberry Pi and official camera
- Set up your HQ Camera or Camera Module and control it with precision
- Fun projects include a wildlife camera trap, security camera, and video doorbell
- 17 chapters packed with essential info for Raspberry Pi photography

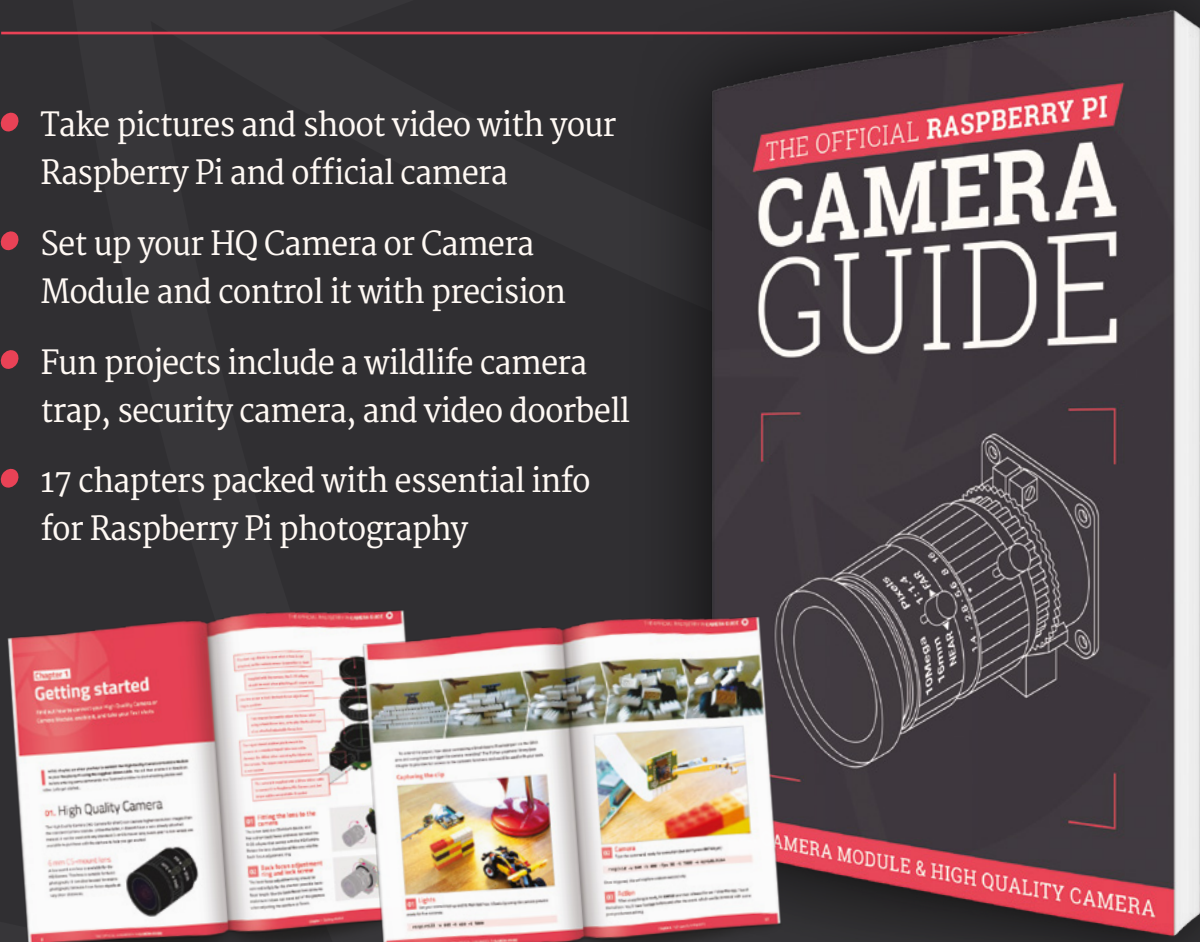

Buy online: [magpi.cc/cameraguide](http://magpi.cc/cameraguide)

# Configuring your magic mirror



MAKER

**PJ  
Evans**

PJ is a writer, tinkerer, and enjoys installing Raspberry Pi Zero computers where no-one asked for them to be.

@mrpjevas

Now that we've built a mini magic mirror, it's time to upscale and take a tour of the powerful software that drives it

**In part one of this guide, we built a simple magic mirror using a semi-transparent piece of acrylic and a cheap picture frame.**

Mounting a Raspberry Pi screen behind it allows text to appear as if floating in air. We also introduced MagicMirror<sup>2</sup>, an application solely designed for creating beautiful displays on your mirror. This month we're going to deep-dive into the software and see how we can customise our display. First of all, you may notice that we've given our mirror a bit of an upgrade, using a 23-inch monitor, semi-transparent film, and a larger Ikea Ribba frame. The software build is the same, just the hardware is bigger.

## 01 Orientate yourself

Can a mirror be upside-down? A magic mirror can! Most mirrors tend to be portrait, whereas screens are normally landscape. Normally we could make some changes to `/boot/config.txt` to easily rotate the screen, but

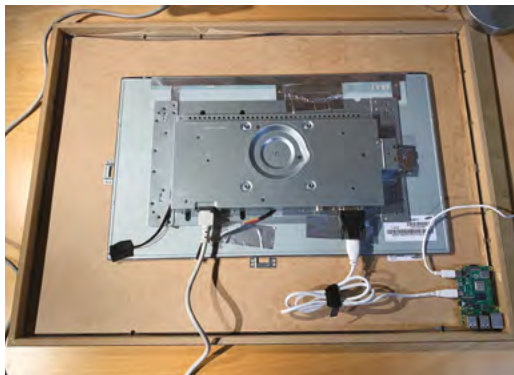

▲ The rear view shows the mounted monitor and Raspberry Pi computer. Removing the monitor's bezel gets the screen as close as possible to the surface

### You'll Need

- ▶ One-way mirror film [magpi.cc/onewayfilm](http://magpi.cc/onewayfilm)
- ▶ Monitor with bezel removed (We used a spare 23-inch screen)
- ▶ Ikea Ribba frames to fit monitor [magpi.cc/ribba2](http://magpi.cc/ribba2)
- ▶ Sample config.js and compliments.js files (optional) [magpi.cc/mm2git](http://magpi.cc/mm2git)

with Raspberry Pi 4's fancy new graphics support, this is no longer possible. To rotate your display 90° so it fits your mirror, open a Terminal and enter the following:

```
sudo nano /etc/xorg/xsession/LXDE-pi/autostart
```

Now add this line to the end of the file:

```
@xrandr --output HDMI-1 --rotate right
```

Save the file (**CTRL+X**) and reboot. Your display should now be portrait.

## 02 Safety first

Sadly, MagicMirror<sup>2</sup> doesn't (yet) come with an easy configuration utility. For now, you will need to do some text editing of `config.js`. Don't worry: as long as you make copies of your files, it's going to be hard to break anything. If MagicMirror<sup>2</sup> refuses to start, just copy the file back. Here's how it works from a Terminal:

```
cd ~/MagicMirror/config
cp config.js config.js.backup
```

If anything goes wrong, just copy the config backup back and try again:

```
cp config.js.backup config.js
```

Each time you edit `config.js`, you'll need to restart MagicMirror<sup>2</sup> for changes to take effect. To do this at any time:

```
pm2 restart MagicMirror
```



## Top Tip

### Back it all up

If you're editing a module or config file, it costs nothing to create a copy – then if it all goes wrong, you can try again.

from (and you can have multiple newsfeeds if you wish). Let's change the newsfeed to the BBC. Find the module 'newsfeed' and you'll see under 'config' the 'feeds'. This is surrounded with square brackets [ ], which means we can have multiple entries. Change 'New York Times' to 'BBC News' and the 'url' to 'http://feeds.bbc.co.uk/news/rss.xml'. Restart MagicMirror<sup>2</sup> and now you're getting the headlines from the UK.

## 07 Vampire mode (no reflection)

By now you may be finding it a little frustrating if you've already put up your mirror. With a bit of reconfiguration, you can access the mirror display using a web browser and work on it from your desktop. Edit **config.js** and have a look at the first few lines under 'config'. These control access to the display. It's locked down by default (which is good), but we can allow other computers access. Change these following lines as shown:

```
address: "",
ipWhitelist: []
```

This allows any IP address on your network to access the server. You'll need to restart MagicMirror<sup>2</sup> for changes to take effect. Now you should be able to see your display at <http://<your mirror's IP address>:8080>.



► It may be easier to configure your screen before mounting it in the mirror

## 08 Client and server mode

The reason we can so easily see the display in a web browser is that MagicMirror<sup>2</sup> is split in to two parts: the client, the software that displays the screen; and the server, which generates the content. This clever split allows you to generate the content from a separate computer on the network, which is handy if you want to do something really intensive. It also allows you to have multiple mirrors that all show the same display, which makes rolling out changes really easy.

To start an installation of MagicMirror<sup>2</sup> without a display (server):

```
node serveronly
```

To create a client that gets its content from the server:

```
node clientonly --address <ip of server>
--port 8080
```

“ In the centre of the screen, there are 'compliments' rotating every few seconds. You can change these ”

## 09 Editing modules

Let's have a look at modifying existing modules. You'll have seen in the centre of the screen, there are 'compliments' rotating every few seconds. You can change these in **config.js**, but let's look in the actual code so we can get a feel of how things are arranged. In Terminal, navigate to where the default modules are installed:

```
cd ~/MagicMirror/modules/default
```

If you do an **ls** to get a directory listing, you'll be able to tell what's available. We're interested in the 'compliments' module:

```
cd compliments
```

Now edit the file:

```
nano compliments.js
```

Look at the various text strings and change them to whatever you like. Save the file and



▲ There are many, many modules available for all kinds of uses. This one shows you a daily Pokémon!

restart MagicMirror<sup>2</sup> to see your new messages. A sample **compliments.js** file can be seen at [magpi.cc/mm2compliments](https://magpi.cc/mm2compliments).

## 10 More modules

Great news: you are not restricted to the default modules. There are hundreds of community-built modules that are free to download and install. They cover all kinds of useful information, including stock prices, local transportation, prayer guides, and even how your local Minecraft server is holding up. Luckily, a directory of MagicMirror<sup>2</sup> modules is maintained on the main site's wiki: [magpi.cc/mirrormodules](https://magpi.cc/mirrormodules).

Most modules will require some configuration, so make sure you look at the **README** file and follow the instructions carefully. There's no limit to how many modules you can have, bar the positions available on the screen.

## 11 Installing modules

Sadly, we don't have a nice package manager for MagicMirror<sup>2</sup>, so installing modules tends to involve using Git to fetch the code. For an example, we're going to install 'Daily Pokemon'. From the Terminal, we'll go to the **modules** directory, then get the code from GitHub.

```
cd ~/MagicMirror/modules
git clone https://github.com/NolanKingdon/
MMM-DailyPokemon
cd MMM-DailyPokemon
npm install
```

The final command gets all the libraries that the module needs to run. Once completed, edit the config file:

## Figure 1

► Language: **JSON**

**DOWNLOAD  
THE FULL CODE:**

 [magpi.cc/mm2config](https://magpi.cc/mm2config)

```
001. modules: [
002.   {
003.     module: "MMM-DailyPokemon",
004.     position: "top_center",
005.     config: {
006.       updateInterval: 600000,
007.       minPoke: 4,
008.       maxPoke: 151,
009.       grayscale: true,
010.       showType: true,
011.       language: "en",
012.       genera: true,
013.       gbaMode: true,
014.       nameSize: 26
015.     }
016.   },
```

```
nano ~/MagicMirror/config.js
```

Create a new line after **modules: [** and add the code from the **Figure 1** listing (or use the download link for the full, edited **config.js** file). Make sure you end with a comma. Restart MagicMirror<sup>2</sup> and admire your daily Pokémon.

## 12 More modules

As we've already said, there's a dizzying array of modules to choose from, and you can even write your own. If you're in the mood for customising, here are a few of our favourites. You can find all of them, along with installation instructions at [magpi.cc/mirrormodules](https://magpi.cc/mirrormodules).

### **magpi.cc/mmmstocks**

Every information screen needs a stock ticker, right?

### **magpi.cc/mmmwiki**

Up your knowledge as you get ready to leave the house with these random snippets from Wikipedia.

### **magpi.cc/mmmukrail**

Is your train going to be on time? If you're in the UK, this module will let you know. Many other countries have equivalent modules too. 

# Facial recognition with a magic mirror



MAKER

**PJ  
Evans**

PJ is a writer, tinkerer, and enjoys installing Raspberry Pi Zero computers where no-one asked for them to be.

@mrpjevas

Mirror, mirror on the wall, who is the fairest of them all? Decide with a smart face-recognising magic mirror

In the previous two instalments, we've built and configured a magic mirror using the impressive MagicMirror<sup>2</sup> software. Now we have our mirror constructed and configured to our liking, it's time to go to the next level of personalisation. Wouldn't it be amazing if the mirror's display could be customised based on the person standing in front of it? Wouldn't it be even better if that could happen by the mirror recognising the person standing there? Turns out, that's well within the capabilities of a Raspberry Pi computer. We'll build multiple mirror configurations that appear when the right person is recognised.

## 01 Magic up a mirror

This project is an enhancement to the tutorials we covered in the previous two instalments (p154 and p162). That means that you're going to need a magic mirror before we go



▲ The official Raspberry Pi Camera Module is a perfect choice for this project

### You'll Need

- ▶ A magic mirror (see parts 01 and 02)
- ▶ Raspberry Pi Camera Module [magpi.cc/camera](http://magpi.cc/camera)
- ▶ 3D-printed case (optional) [magpi.cc/cameracase](http://magpi.cc/cameracase)

any further. To recap, we made a 'budget' version using the Raspberry Pi official touchscreen, a small Ikea frame, and a generous amount of gaffer tape. Basic, but surprisingly functional. Having given it all a bit of a polish (software speaking) in the second article, we'll be building upon our current mirror. If you've gone your own way, that's great: the instructions will be roughly the same.

## 02 Casing the camera

If we're going to add the ability to customise the display based on who is standing in front of it, then we're going to need some vision. The easiest choice would be the official Raspberry Pi Camera Module. It's small, powerful, and easy to connect. How you want to mount the camera to your project is entirely your call. Here, we've 3D-printed a small case for the module so it fits in with its surroundings. The small case matches the frame and was easily secured with some strong tape. The more ambitious of you may consider mounting a camera directly in the frame.

## 03 Attach and enable the camera

Whatever camera solution you decide to use, you'll need to connect it to your Raspberry Pi computer. If you're using a Camera Module, attach the ribbon cable to the main board following the instructions here: [magpi.cc/picamera](http://magpi.cc/picamera). Once connected to the board, configure it by running `sudo raspi-config` from the command line and enabling the camera under 'Interfacing Options'. If you've gone with a USB webcam, see the instructions provided with it and check for Raspberry Pi compatibility before purchasing.

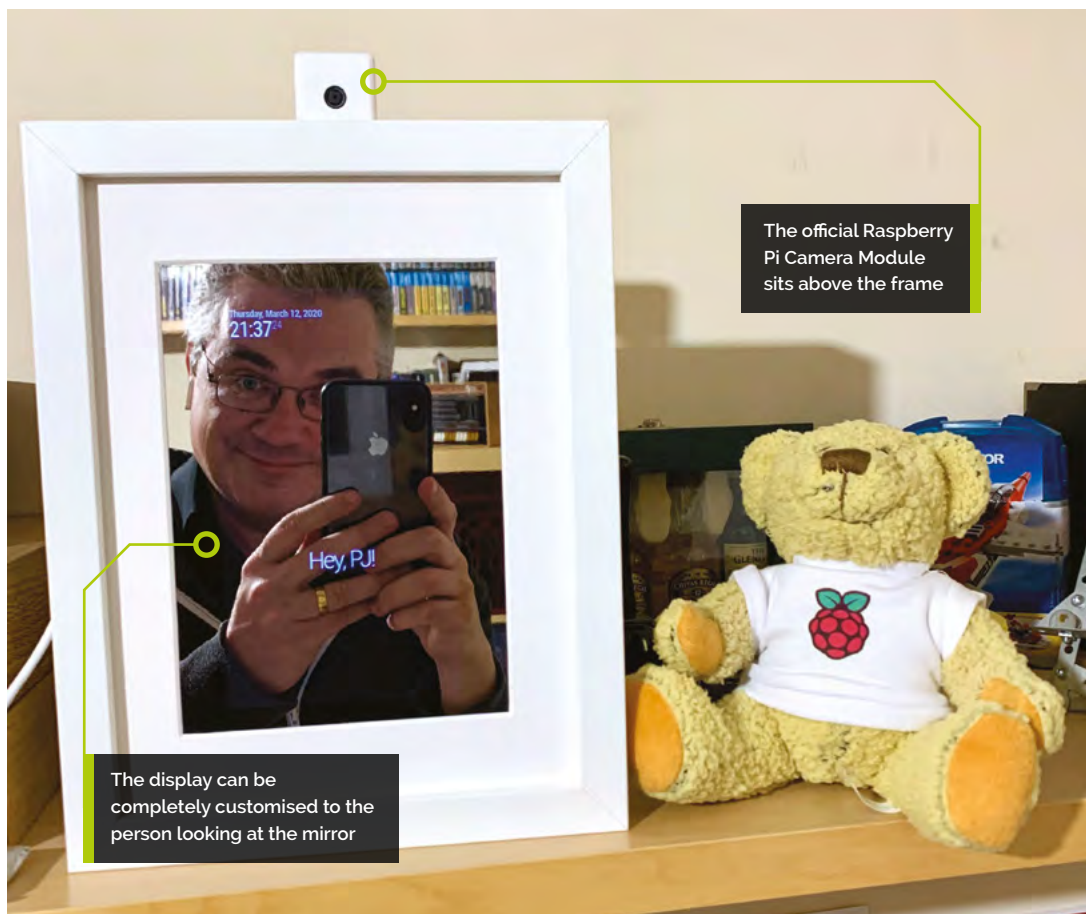

The official Raspberry Pi Camera Module sits above the frame

The display can be completely customised to the person looking at the mirror

## Top Tip

### Screen rotation

No luck with face recognition? Train, train, and train again. The more data, the more accurate the result.

## 04 Rotate the screen

The positioning of the camera may make you reconsider which way around you would like the mirror. If using the Camera Module, the provided ribbon cable requires that the mirror is portrait with the Raspberry Pi computer at the top. Changes in graphics systems with the move to Raspberry Pi 4 and Raspberry Pi OS mean the easiest way to set the screen orientation is within the desktop itself. Stop the MagicMirror<sup>2</sup> software by entering this at the command line: `pm2 stop MagicMirror`. Then, in the desktop environment, go to the menu, select 'Preferences', then 'Screen Configuration'. Right-click 'DSI-1' and select 'orientation', then 'right'. Now click the 'tick' to save.

## 05 Install OpenCV and more

Now we're ready to get to work. To be able to recognise faces, we need some artificial intelligence. The amazing OpenCV software is not only free of charge but also superb at recognising objects, including individual human faces. Understandably, it's a monster of an application, so we recommend a Raspberry Pi 4

with at least 2GB of memory. You can run it on older models, but it's a lot more complicated. See the excellent [pyimagesearch.com](https://pyimagesearch.com) resource for more information. To install, run the following from the command line:

```
sudo apt -y update && sudo apt -y upgrade
sudo apt install libopencv-dev python3-opencv
```

## 06 Tool up

To be able to accurately identify someone's face, we need to train our magic mirror. Using machine learning systems, we'll take photos of the mirror's users and create mathematical models of those faces so the mirror can recognise them in future. To do this, we'll download some tools. Run the following commands:

```
cd ~
git clone https://github.com/mrpjevans/MMM-Facial-Recognition-Tools.git
```

(If you get an error, run `sudo apt install git`, then try again.)

**Top Tip** **PyImageSearch**

Want to know more about image processing and recognition using Python? There's no better resource than Adrian Rosebrock's [pyimagesearch.com](https://pyimagesearch.com).

We now have a collection of tools to help train our mirror to the various faces it may encounter.

**07 Training time**

Now it's time to train our mirror. Run the following commands:

```
cd ~/MMM-Facial-Recognition-Tools
python3 capture.py
```

Choose whether to capture live photos from your webcam, or train from JPEG photos (you'll need to upload them in advance). You'll be asked for your name. Keep it simple. Your author chose 'pj', avoiding capitalisation, spaces, and special characters. You should now see your face on the mirror's display. Line up your face with how you think you'll be looking at the mirror ('in situ' is best) and press **ENTER** to take a snapshot of your face. Repeat this at least ten times before pressing **CTRL+C** to stop.

Finally, run `python3 train.py` to convert the images into mathematical data. When prompted for an algorithm, select LBPHF.

**08 Testing time**

To verify that the training worked, a testing script is provided. From the same directory, run these commands:

```
export FACE_ALGORITHM=1
export FACE_USERS=pj
python3 facerecognition.py
```

(Replace 'pj' with the name you chose.)



After the script has started up, have a look into the camera at the same angle you took the training photos. If all is well, you'll see reports that your face has been identified! This means the mathematical model has matched you with what it is currently seeing. If you don't get good results, try retraining or changing the lighting. Repeat the process until you're getting satisfactory results.

**09 Install the module**

Now we have our machine-learned data, we can go ahead and install the actual facial recognition module. To do this, we need to install some code in the MagicMirror<sup>2</sup> **modules** directory:

```
cd ~/MagicMirror/modules
git clone https://github.com/mrpjevans/MMM-Facial-Recognition
```

This installs all the files we need to add the module into the system. To complete the installation, we need to add dependencies:

```
cd MMM-Facial-Recognition
npm install
```

After a short time, all the files we need to run the module will be installed.

Finally, make a copy of the training data from Step 07 into the **modules** directory:

```
cp ~/MMM-Facial-Recognition-Tools/training.xml ~/MagicMirror/modules/MMM-Facial-Recognition/
```

**10 Configure the module**

Now we're all ready to add the module to our magic mirror. Just like last month's tutorial, we need to edit the `/config/config.js` file to add our module in. This is in JSON (JavaScript object notation) format, which is unforgiving of errors, so add things in carefully and if in doubt, make a copy of the file first so you can also 'roll back' should it be needed.

```
nano ~/MagicMirror/config/config.js
```

Scroll down the file until you see the 'modules' section. There will be a series of entries grouped by



{ and }, all of them grouped in [ and ]. You need to add the **list1.js** listing printed here into the [ and ] group. Each group of { and } needs to be separated by a comma (except for the final one). Don't save the file just yet.

“ After a few seconds, the system should restart and the ‘default’ modules are shown ”

## 11 Customise the modules

Have a look at the config section you've just added. Where it says ‘users’, make sure the names in the following square brackets match the ones you have trained for. Ours was ‘pj’ so it should read [‘pj’]. If you trained multiple people, separate them with commas: [‘alice’, ‘bob’].

Now, for each module you want to customise per person, add an extra parameter of ‘classes’. This is a string with multiple entries separated by spaces. Add ‘default’ for always shown, ‘everyone’ for every recognised face, and specific names if that module is only to be shown for that person. See the **list2.js** listing for an example.

## 12 Try it!

Now it's finally time to try out your mirror. Restart MagicMirror<sup>2</sup> by running this command:

```
pm2 restart MagicMirror
```

After a few seconds, the system should restart and the ‘default’ modules are shown. Have a look into the camera as you did for training and see if your modules appear. After a second or two, the mirror should refresh with your choice of display.

If you have any problems, use SSH to connect to your mirror and run **pm2 logs**. This will show you a live update of what's going on. Typically, any problems will be either not enough training or poor lighting. Just retrain by following the earlier steps and have another go. Soon you'll have a cool mirror that is unique to each of its visitors. 📺

Thanks to Paul-Vincent Roll, author of the original MMM-Facial-Recognition module.

## list1.js

> Language: JSON

```
001.
002. {
003.     module: 'MMM-Facial-Recognition',
004.     config: {
005.         // Array with usernames (copy and paste
006. from training script)
007.         users: ['pj']
008.     }
009. }
```

## list2.js

> Language: JSON

```
001. var config = {
002.
003.     ...
004.
005.     modules: [
006.         {
007.             module: "clock",
008.             position: "top_left",
009.             classes: 'default'
010.         },
011.         {
012.             module: "compliments",
013.             position: "lower_third",
014.             config: {
015.                 compliments: {
016.                     anytime: [
017.                         "Hey, PJ!"
018.                     ]
019.                 }
020.             },
021.             classes: 'pj'
022.         },
023.         {
024.             module: 'MMM-Facial-Recognition',
025.             config: {
026.                 // Array with usernames (copy
027. and paste from training script)
028.                 users: ['pj']
029.             }
030.         }
031.     ]
032.
033. };
```

# Create modules for your magic mirror



MAKER

PJ  
Evans

PJ is a writer and software engineer. His Smol Robot would probably be fuelled by coffee and mild panic.

@mrpjevens

Can't find the perfect add-on for your magic mirror? Why not make your own? In this tutorial we'll create a fun module for MagicMirror<sup>2</sup>

**A**s we've covered in the previous magic mirror tutorials, there are hundreds of modules out there to display custom information on your MagicMirror<sup>2</sup> display, including stock prices, the weather, or even your favourite Pokémon. So what to do when you can't find what you're looking for? Write your own of course! The module system in MagicMirror<sup>2</sup> lets anyone add custom code to their mirror with powerful control over the display. You can even interact with other modules. As a simple introduction, we're going to build a simple module that displays the latest cute little robot from the @smolrobots Twitter account.

## 01 Set up your mirror

To make sure we don't get confused with anything else, we recommend removing everything from your display except the clock – which we'll use to check that everything is working, as MagicMirror<sup>2</sup> does its best to keep calm and carry on if a module has a problem. Logging in as the 'pi' user, first make a copy of the config file:

```
cp ~/MagicMirror/config/config.js
~/MagicMirror/config/config-backup.js
```

Now have a look at the file:

```
nano ~/MagicMirror/config/config.js
```

You will see JSON-formatted text. Find the 'modules' section and remove everything so it looks like this:

```
modules: [
  {
```

```
    module: "clock",
    position: "top_left"
  }
]
```

Press **CTRL+X** followed by **Y** to save. Now restart the software to make sure everything has taken effect:

```
pm2 restart MagicMirror
```

## 02 Choose how to code

If you can't access your mirror with a display and keyboard (as it's busy being a magic mirror), you'll need to find a way of coding on your Raspberry Pi. You can SSH in and use nano or vi if you like. If you have a capable SFTP client, you can also use this to access files in your home directory and then work on them on your 'regular' computer using a JavaScript code editor such as Visual Studio Code. MagicMirror<sup>2</sup> is written using JavaScript, so Python editors such as Thonny cannot be used.

## 03 How to create a module

Each MagicMirror<sup>2</sup> module is a JavaScript file and the code inside is called a class. The class has several built-in methods (like functions) that we don't see and the server calls them to get the information it needs to create the display. What we need to do is replace (or 'override') one or more of the methods to get the output we want. You'll find all modules in the **~/MagicMirror/modules** directory. The built-in displays such as the clock are, unsurprisingly, in 'default'. Create a folder alongside default called **MMM-Hello-World**

### You'll Need

- ▶ A magic mirror running MagicMirror<sup>2</sup>
- ▶ JavaScript code editor such as Visual Studio Code [magpi.cc/visualstudio](https://magpi.cc/visualstudio)
- ▶ 3D-printed case (optional)

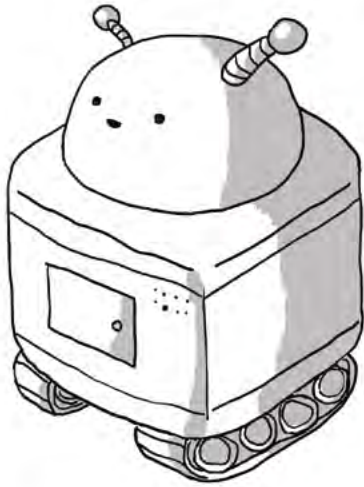

▲ Thomas Heasman-Hunt's Smol Robots are a favourite in the Raspberry Pi community. He even designed the Pi Wars robot!

(MMM = Magic Mirror Module). Inside the folder, create a blank file called **MMM-Hello-World.js**.

## 04 Hello World

As you've probably guessed, we're going to create a simple 'Hello World' module. Enter the code in **listing1.js** (or download it from [magpi.cc/mm4git](http://magpi.cc/mm4git)) using your code editor. Use nano if you wish, but a proper editor will do all kinds of highlighting and syntax checking which makes it much easier to fix typos and bugs. The code overrides the 'getDom' method, which is called when the server wants us to return some content. Here we create a HTML element, 'div', and add the text to it that is defined in the defaults section. We then return that HTML object to the server to place on the display.

“ A proper editor will do all kinds of highlighting and syntax checking ”

## 05 Try it!

To actually get our message to display on the screen, we have to ask MagicMirror<sup>2</sup> to load the module. Let's go back to the config file:

```
nano ~/MagicMirror/config/config.js
```

Find the 'modules' block, as we did previously, and modify it so it looks like this:

```
modules: [
  {
    module: "clock",
```



We're going to display the latest small robot, but we'll have to invert the image first

When developing modules, keep the clock enabled so you can quickly see if something has frozen

```
    position: "top_left"
  },
  {
    module: "MMM-Hello-World",
    position: "lower_third"
  }
]
```

Save the file and restart MagicMirror<sup>2</sup> as in the earlier step. You should now see 'Hello World!' displayed at the bottom of the mirror. You've created your first module! You can also specify a custom message in **config.js** like this:

```
{
  module: "MMM-Hello-World",
  position: "lower_third",
  config: {
    text: "MagPi rocks!"
  }
}
```

This overrides anything in 'defaults' in your module.

## Top Tip

What's this 'Dom' business?

The 'Dom' in 'getDom' and 'updateDom' refers to the Document Object Model (DOM), which is how the browser structures the webpage you are viewing.

**Top Tip** **Learn JavaScript**

New to JavaScript? Read our guide to learning this powerful language in *The MagPi* issue 93 ([magpi.cc/93](http://magpi.cc/93)).

**06 Create the Smol Robots module**

Let's get a bit more advanced. Thomas Heasman-Hunt draws cute little robots a few times a week and posts them on Twitter. Wouldn't it be nice to be greeted by a little robot in the morning when we looked in the mirror? Luckily, Tom Panton has created an API that lets us fetch the very latest robot, so we can use that to get the robot image and display it. Create a directory under modules:

```
mkdir ~/MagicMirror/modules/MMM-Smol-Robots
```

Now create a matching JavaScript file:

```
touch ~/MagicMirror/modules/MMM-Smol-Robots/MMM-Smol-Robots.js
```

**07 Accessing the API**

Open the file you created in the previous step in your favourite editor and enter the code in **listing2.js**. This is JavaScript, so be careful with the curly brackets and semicolons. Again, we're overriding 'getDom' but this time we're using the built-in 'fetch' function to get information from the Smol Robots API. If you want to see what we're getting, enter the following URL in a web browser:

<https://mrpjevans.com/smol/api/latest/1>

What is returned is a block of JSON-formatted data about the latest robot. You should be able to find

**listing1.js**

► Language: **JavaScript**

```
001. Module.register("MMM-Hello-World",{
002.     // Default module config.
003.     defaults: {
004.         text: "Hello World!"
005.     },
006.
007.     // Override dom generator.
008.     getDom: function() {
009.         var wrapper = document.
createElement("div");
010.         wrapper.innerHTML = this.config.text;
011.         return wrapper;
012.     }
013. });
```

its name, description and, most importantly, the location of the image file.

**08 Get a robot!**

Save your code and edit the config file again to replace the 'Hello world' module. Your config file's modules block should look like this:

```
modules: [
  {
    module: "clock",
    position: "top_left"
  },
  {
    module: "MMM-Smol-Robots",
    position: "lower_third"
  }
]
```

Restart MagicMirror<sup>2</sup> as before. Within a few seconds, a delightful robot will grace your screen. The code has accessed the API, located the URL to the image, and created a block of HTML that calls the image in at a reasonable size (feel free to tweak this). The HTML object generated is then returned to the server, which places it in the desired position.

“ This is JavaScript, so be careful with the curly brackets and semicolons ”

**09 Let's be negative**

But wait! There's a problem. Smol Robots are always black ink on white, which doesn't work well with our mirror. Sure, if you're happy with it displayed this way, that's up to you, but if we could invert the image, it would look much better.

Thankfully, the powerful world of CSS (Cascading Style Sheets) can do just that. Find the line that reads:

```
img.style = "width: 300px;";
```

Now change it to read like this:

```
img.style = "width: 300px; filter:
invert(1);";
```

'Filter' is a powerful style rule that can perform all manner of tricks on images. In this case, we ask it to

invert all the colours. Save the file and reload your magic mirror. Ah, that's much nicer: our robot now seems to float on the screen.

## 10 More robots!

Our robot is displaying, but what about when a new robot is unleashed from the Smol Robots laboratory? Typically this happens a few times a week, so a daily check should suffice. We can do this by setting up a timer function to refresh the module. Right after the 'defaults' block, add **listing3.js**. This override is called once when the server is started. We use it to set up a timer that will call `updateDom` (which in turn triggers `getDom`) once a day. You can change this value in the defaults section or specifying a value in **config.js**. Now your robots will appear like magic.

## 11 Publishing modules

If you've got an idea for a module, and now have enough knowledge to get started, great! When it's done, why not share it with the community? The main page for third-party modules is **magpi.cc/mirrmoudles**. We recommend hosting your module on a service like GitHub. Then you can edit this webpage and add your module to the list. Make sure to read (and follow) the guidelines and be prepared to offer support.

## 12 Experiment

This has been only a brief introduction to the world of MagicMirror<sup>2</sup> modules. There is a wealth of information in the official documentation (**magpi.cc/mm2doc**), where you can learn about the other tricks possible. As well as communicating with the outside world, as we have done here, you can communicate with other modules. The weather module can tell you the temperature, or alert you when there's new data. The calendar broadcasts an alert when it's time for an appointment and you can react to that. We hope you get planning and would love to see the results. 📅

Many thanks to Thomas Heasman-Hunt for letting us borrow their robots. Check out their latest book at **magpi.cc/smallrobotsbook**. Also, thank-you to Tom Panton for provision of the API.

## listing2.js

> Language: JavaScript

```
001. Module.register("MMM-Smol-Robots", {
002.   // Default module config.
003.   defaults: {
004.     feed: "https://mrpjevans.com/smol/api/latest/1",
005.     updateInterval: 3600 * 24,
006.     fadeSpeed: 4000
007.   },
008.
009.   // Override dom generator.
010.   getDom: async function() {
011.
012.     Log.info("Refreshing Smol Robot");
013.
014.     // Get the latest Smol Robot
015.     const response = await fetch(this.config.feed);
016.     const bots = await response.json();
017.     const bot = bots[0];
018.
019.     // Wrap the image URL in an IMG element
020.     const img = document.createElement("img");
021.     img.src = bot.image.url;
022.     img.style = "width: 300px;";
023.
024.     // Add title and description
025.     const title = document.createElement("div");
026.     title.innerHTML = bot.name.full;
027.     const description = document.createElement("small");
028.     description.innerHTML = bot.description;
029.
030.     // Create a wrapper element and return
031.     const wrapper = document.createElement("div");
032.     wrapper.appendChild(img);
033.     wrapper.appendChild(title);
034.     wrapper.appendChild(description);
035.     return wrapper;
036.   }
037. });
```

## listing3.js

> Language: JavaScript

```
001. start: function() {
002.   Log.info("Starting module: " + this.name);
003.
004.   var self = this;
005.
006.   // Schedule update timer.
007.   setInterval(function() {
008.     self.updateDom(self.config.fadeSpeed);
009.   }, this.config.updateInterval);
010. },
```

RASPBERRY PI

# PROBLEMS SOLVED!

DIAGNOSE AND FIX ISSUES  
ON YOUR RASPBERRY PI  
WITH **ROB ZWETSLOOT**

**R**aspberry Pi is an incredible computer, and we love using ours to experiment like some sort of eighties movie LED and robot scientist. However, like everything, it's not flawless. Same with us Raspberry Pi users. Due to the unpredictable nature of mixing machine and human nature, sometimes things go a bit wrong.

This is where this article comes in. Everyone needs to learn how to correctly solve their computing issues, and through this easy-to-follow guide we'll show you some common fixes, starting from the basics, all the way up to more advanced issues. Put away the soldering iron and get ready to read.

SETTING UP  
YOUR FIRST  
RASPBERRY PI?

CHECK OUT OUR QUICKSTART  
GUIDE FOR COMPLETE STEP-  
BY-STEP INSTRUCTIONS

[magpi.cc/quickstart](https://magpi.cc/quickstart)

# CONTENTS

176

**BASIC PROBLEMS**  
ODD GLITCHES,  
UNUSUAL BEHAVIOUR



LEVEL

178

**BOOT PROBLEMS**  
RASPBERRY PI OS  
DOES NOT START



LEVEL

180

**NETWORK PROBLEMS**  
CAN'T CONNECT TO THE  
NETWORK OR INTERNET



LEVEL

## FIRST TESTS

ALWAYS CHECK THESE BEFORE  
GOING ANY FURTHER...

### 01 Cables

Make sure that everything is properly plugged in to your Raspberry Pi – this includes power, HDMI, USB, Ethernet, audio, etc. If in doubt, give it a gentle jiggle in the slot and firmly push it in. Double-check the other end of the cables as well.

### 02 microSD card

Make sure a microSD card is inserted properly into the underside of your Raspberry Pi. Again, push it firmly in – if needed, take your Raspberry Pi out of its case before doing this.

### 03 Monitor

Connect to a monitor or display and turn it on before booting your Raspberry Pi – sometimes a Raspberry Pi won't output a video signal if there's nowhere for it to output to.

# TOP 10 SIMPLE SOLUTIONS FOR SIMPLE PROBLEMS

EVERYONE'S A NEWBIE AT SOME POINT. HERE ARE SOME COMMON PROBLEMS YOU MAY NEED TO LEARN ABOUT

## Lightning bolt / not enough power

 A telltale sign of a Raspberry Pi not having enough power is a lightning bolt symbol appearing in the corner of the screen, or a peripheral/accessory not working properly. You need to make sure you have a powerful enough supply for your Raspberry Pi – this means a rating of 5V 2.5A for a Raspberry Pi 3B+ and below, or 5V 3A for a Raspberry Pi 4.

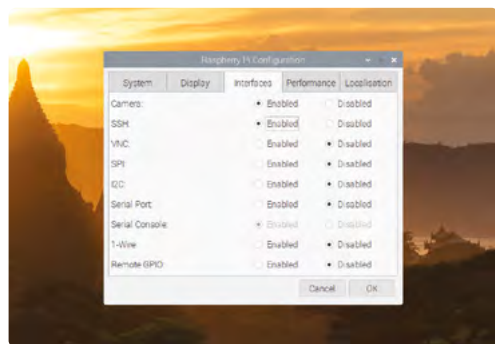

## Camera not detected

 Using a Raspberry Pi Camera Module is usually straightforward. However, if it won't respond to commands then it may likely be a couple of things. First of all, check it's plugged in the correct way. Only one side of the ribbon cable has silver connectors and they need to line up with the connectors in the Camera slot. Secondly, you may need to enable the Camera in the Raspberry Pi Configuration tool – under the Interfaces tab.

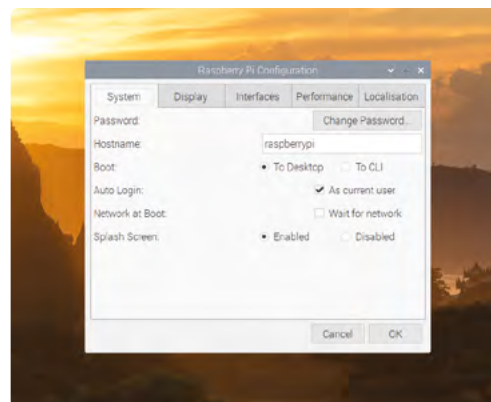

## Desktop does not appear

 If you've turned on your Raspberry Pi and are greeted with a command line instead of the desktop, it may have been told to boot to the command line instead. Run the command **startx** to boot into the desktop, then go to Raspberry Pi Configuration to change the option to boot 'To Desktop' – under the System tab.

## Reusing a microSD card

 Once upon a time, you were pretty easily able to transfer a working microSD card from one Raspberry Pi to another. Unfortunately, that doesn't always work any more, and you'll be forced to reinstall Raspberry Pi OS (or your preferred OS) onto the card – see page 11. Make sure to back up any important files to a USB stick or the cloud before doing so, though – it will completely wipe the card.



## General online help

If you have an issue that isn't covered here, then the best place to go is the Raspberry Pi Forum: [rpf.io/forums](http://rpf.io/forums). It's full of amazing and friendly people who have helped folks with many Raspberry Pi problems. Search for your problem first; then, if you can't find it, start a thread in the Troubleshooting section.

## No picture on Raspberry Pi 4

We've all stumbled into this problem and spent far too long trying to fix it: long story short, Raspberry Pi 4 likes to boot from the 'HDMI 0' output, which is the one closest to the power port. You may just need to switch over the cable from the other HDMI port.

## Code won't run

You've written out your code or copied it from the magazine and it won't run. What to do? You should get an error message when this happens, and it will list the problem and where it happened. If you don't understand the error message, make sure to check the line it mentions. If that doesn't help you spot an error, put the error message into your search engine of choice.

## Booting quick fix

Having problems booting? Before you head over the page, try formatting and then reinstalling Raspberry Pi OS (or whatever OS you prefer) and try again. While uncommon, installation issues can occur. This is especially common if you've just installed an OS.

## Networking quick fix

Wireless LAN having issues? Ethernet causing a fuss? Sometimes you just need to reboot your Raspberry Pi. If that doesn't work, head over to our 'network fixes' section on page 34.

## Software doesn't work

If a piece of software isn't running properly, then it may require an update. Open up the Terminal and type the following two lines to update all your software:

```
sudo apt update
sudo apt upgrade
```

## GPIO pin doesn't work

If you're programming a button or LED or any other component connect to Raspberry Pi's GPIO, you need to make sure to reference the correct GPIO pin. Double-check your code and wire against the image below. If they're correct, you may just need to move it to a different available pin.

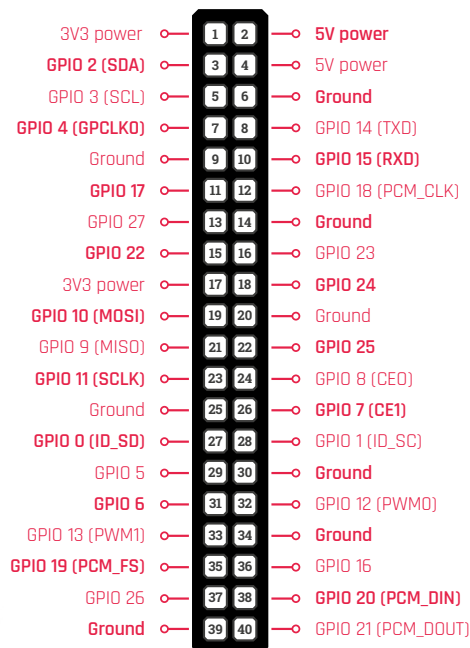

# SOLVING BOOT ISSUES

RASPBERRY PI NOT TURNING ON PROPERLY?  
HERE ARE SOME THINGS TO LOOK OUT FOR

## General online help

THE ACT LED ALSO HAS SPECIFIC PATTERNS FOR SPECIFIC FAULTS. FIND OUT WHAT THEY ARE HERE:

[magpi.cc/actled](https://magpi.cc/actled)

### Blinking ACT light

▶ On the opposite end of the USB and Ethernet ports on a Raspberry Pi, you'll notice there are two little LEDs. The red one shows if there's power, while the green one is the ACT light. If the ACT light is blinking erratically during bootup, it means it's reading the microSD card fine. If it's not blinking at all, it means it can't read the microSD card and so you may need to use a new one or reinstall your OS – see page 11.

### No power LED

▶ Very simply, this means not enough or no power is getting to your Raspberry Pi. If the power supply drops below 4.65V, this red LED will not light up. You may need to check your power supply for faults, including a broken connector, and replace it. If you've checked your power supply and it's all working (on another device), if the problem Raspberry Pi isn't turning on then it's likely the board is broken.

Note: the first-generation Raspberry Pi model has a polyfuse – if this gets blown, it can reset/repair itself, but you may have to wait a few days for this to happen.

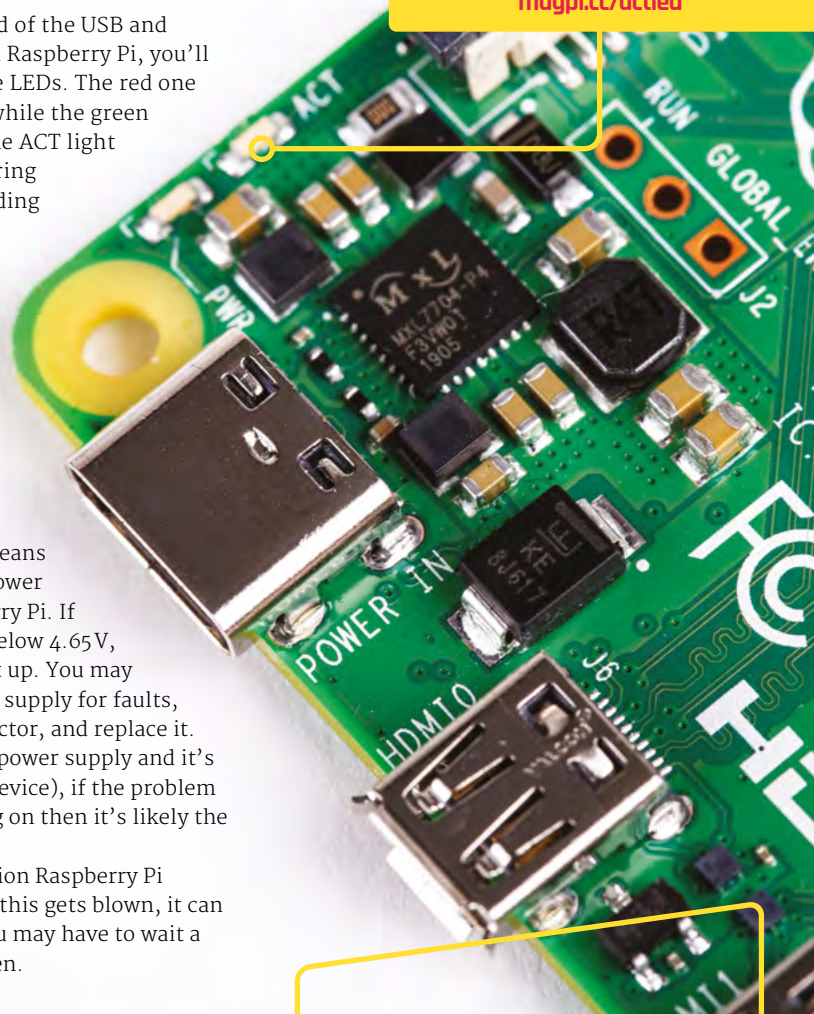

## Boot documentation

Need more advanced boot solutions? Check the documentation for Raspberry Pi on the Raspberry Pi website here: [magpi.cc/bootdocs](https://magpi.cc/bootdocs)

## Raspberry Pi Zero

### Power problems

▶ Raspberry Pi Zero only has an ACT LED, so you will need to check your power supply if it won't boot up. We suggest trying the power and microSD card on another Raspberry Pi Zero if one is available.



### NOOBS issues

▶ Not all versions of NOOBS work correctly with all Raspberry Pi Zero models. Instead of relying on NOOBS for your Raspberry Pi Zero, you should use the new Raspberry Pi Imager software to install Raspberry Pi OS to a microSD card. You can find it at [magpi.cc/imager](https://magpi.cc/imager). See page 11 of this book for more details.

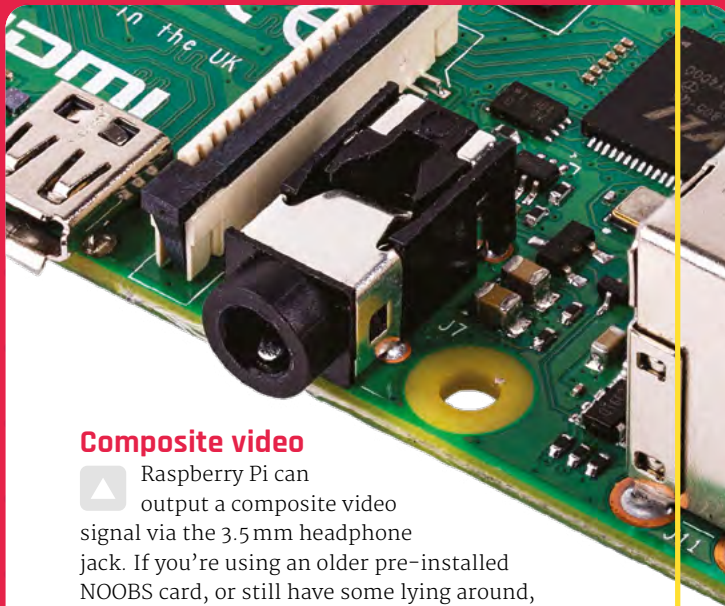

### Composite video

▶ Raspberry Pi can output a composite video signal via the 3.5 mm headphone jack. If you're using an older pre-installed NOOBS card, or still have some lying around, it's good to know that holding the number **3** key on a connected keyboard will force it to output via the composite output if that's what you're using. If you're in the US or another NTSC country, hold the **4** key instead.

### Corrupt microSD card

▶ While uncommon, microSD cards can sometimes become corrupted while being used in a Raspberry Pi. Unfortunately, there's no solution to this other than getting a new microSD card, so make sure to back up your card regularly. You can do this by saving any important files, or even by making an image from your current card. We have a video on how to do this here: [magpi.cc/backupvid](https://magpi.cc/backupvid)



# NETWORK FIXES

CAN'T CONNECT TO YOUR LAN? NO INTERNET?  
HERE ARE SOME THINGS YOU CAN DO

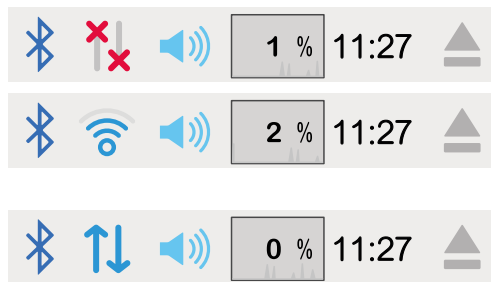

## Understanding network symbols

The network symbols in Raspberry Pi OS are pretty easy to read, and there are three with which you should be familiar. The first symbol is two grey lines with a red X on opposite ends – this denotes no network connection of any kind. Two blue arrows facing in opposite directions means you have a wired connection working, while the circle with waves emanating from it means you have a wireless connection.

## Speed differences

Different Raspberry Pi models have different connection speeds, especially on Ethernet connections. Raspberry Pi 3 and below max out at about 100Mbps as they use a 100MB adapter over USB. Raspberry Pi 3B+ is roughly 280Mbps, as it has a Gigabit Ethernet connection on a USB 2 line. Raspberry Pi 4, however, is a full gigabit. If you're having speed issues, make sure your router or switch supports up to the speeds you're expecting, and test with different Ethernet cables.

## Desktop does not appear

If you don't have a wired connection handy, you can add settings for your wireless network onto the boot folder of a Raspberry Pi microSD card. Create a file there called `wpa_supplicant.conf` and add your network details like so:

```
ctrl_interface=DIR=/var/run/wpa_
supplicant GROUP=netdev
update_config=1
country=<Insert country code here>

network={
  ssid="<Name of your WiFi>"
  psk="<Password for your WiFi>"
}
```



### Wireless testing

There are a lot of things that can interfere with your wireless reception in your home. Distance from your router, interference from neighbours, walls, and even just too many people on the same channel. We like to use apps like Wifi Analyzer to test locations around our home to find out the best spots to place wireless devices such as a Raspberry Pi.

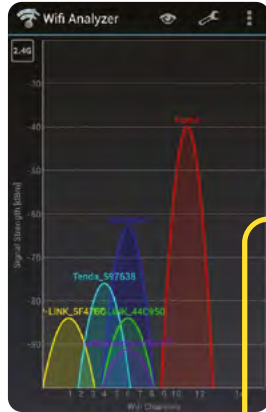

### SSH connection

Many security precautions have been implemented in the last couple of years to make sure Raspberry Pi OS and Raspberry Pi are more secure – this includes making sure people change the password on their Raspberry Pi, and keeping SSH off. You can turn it on from the Interfaces tab in Raspberry Pi Configuration – or, if you’re using a headless Raspberry Pi, simply place an empty file called **ssh** in the boot folder of the microSD card.

### Wired Raspberry Pi Zero

Raspberry Pi Zero does not include an Ethernet port. However, if you need to use a wired connection, you can always use a USB Ethernet dongle. It may not be as speedy as other Raspberry Pi models, but it will do the job.

### Raspberry Pi Zero and A gadget issues

A workaround for a lot of people wanting a portable, network connected computer is to put it into ‘gadget’ or USB boot mode. If you’re having trouble and want to deactivate it, either flash the microSD card (see page 11) or head to the usbboot documentation to fix your setup: [magpi.cc/usbboot](http://magpi.cc/usbboot)

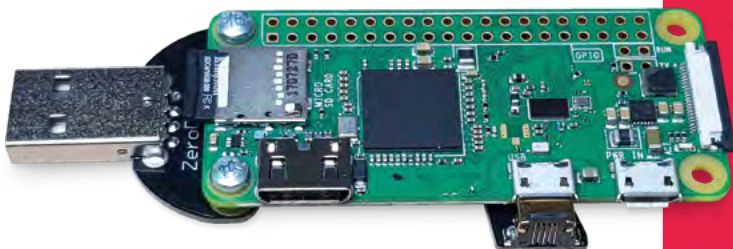

## Networking documentation

Not finding your problem here? Check the configuration documentation for more info on networking with Raspberry Pi OS and Raspberry Pi: [magpi.cc/configdocs](http://magpi.cc/configdocs)

## Networking booting and PoE

Raspberry Pi 3/3B+ and 4 support network booting, and Raspberry Pi 3B+ and 4 even support Power over Ethernet with the PoE HAT.

These are advanced methods and have some issues you might come across, such as DHCP timing out, ARP check failing, and others. For full details on how to set it up and troubleshoot, we suggest heading to the network booting documentation here: [magpi.cc/netboot](http://magpi.cc/netboot)

# SUBSCRIBE TODAY FROM ONLY £5

## SAVE UP TO 35%



### Subscriber Benefits

- ▶ **FREE Delivery**  
Get it fast and for FREE
- ▶ **Exclusive Offers**  
Great gifts, offers, and discounts
- ▶ **Great Savings**  
Save up to 35% compared to stores

### Rolling Monthly Subscription

- ▶ Low monthly cost (from £5)
- ▶ Cancel at any time
- ▶ Free delivery to your door
- ▶ Available worldwide

### Subscribe for 12 Months

£55 (UK)      £90 (USA)  
£80 (EU)      £90 (Rest of World)

Free Raspberry Pi Zero W Kit with 12 Month upfront subscription only (no Raspberry Pi Zero W Kit with Rolling Monthly Subscription)

📞 Subscribe by phone: **01293 312193**

📧 Subscribe online: **magpi.cc/subscribe**

✉ Email: **magpi@subscriptionhelpline.co.uk**

JOIN FOR 12 MONTHS AND GET A

# FREE Raspberry Pi Zero W Starter Kit

WITH YOUR FIRST  
12-MONTH SUBSCRIPTION

Subscribe in print  
today and you'll  
receive all this:

- ▶ Raspberry Pi Zero W
- ▶ Raspberry Pi Zero W case with three covers
- ▶ USB and HDMI converter cables
- ▶ Camera Module connector

This is a limited offer. Not included with renewals. Offer subject to change or withdrawal at any time.

WORTH  
**£20**

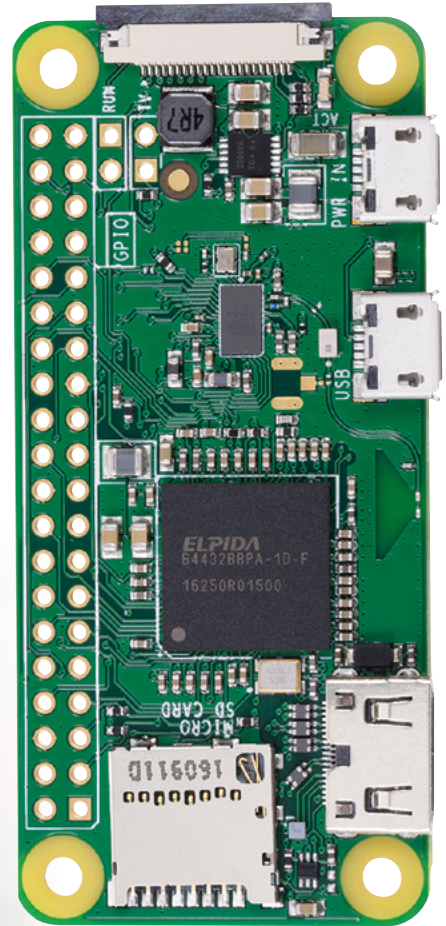
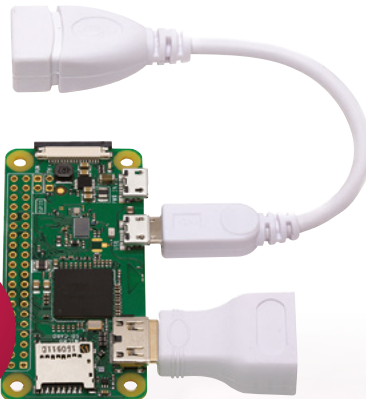

 Buy now: [magpi.cc/subscribe](https://magpi.cc/subscribe)

**SUBSCRIBE**  
on app stores

From **£2.29**

 Available on the  
App Store

GET IT ON  
 Google Play

# Reviews

186

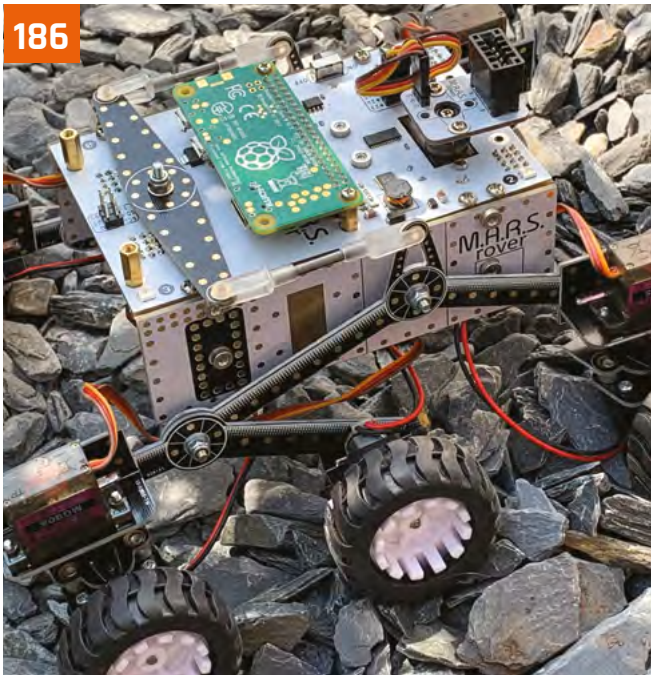

188



190



189





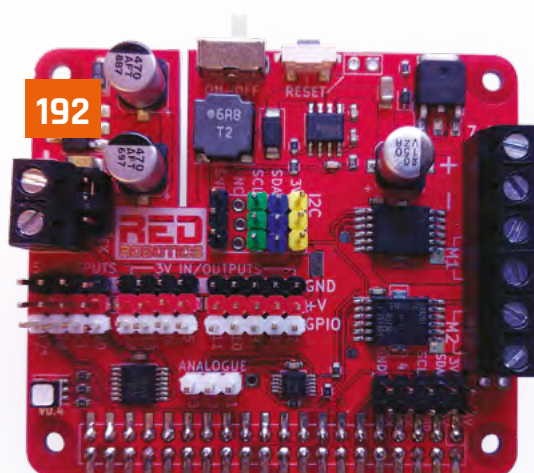

192



194

## Reviews

### 186 M.A.R.S. Rover

Explore new territory with this sophisticated six-wheeled robot kit

### 188 SmartiPi Touch 2

Smart-looking case for the discerning touchscreen user

### 189 Enviro

Environment-sensing board with a mini LCD screen

### 190 Argon Neo & Fan HAT

Stylish protective case with optional fan add-on

### 192 RedBoard+

Feature-packed robotics board with plenty of power

### 194 Unicorn HAT Mini

Versatile mini RGB LED matrix with bright pixels

### 195 HAT Hacker HAT

Two sets of 40 GPIO pins to connect multiple boards

### 196 RetroFlag GPi Case

Eighties handheld-inspired case with screen

### 197 Maker pHAT

A board to help you get started with physical computing

### 198 10 Best: Raspberry Pi cases

Keep your Raspberry Pi safe with these amazing cases

### 200 10 Best: Starter kits

Get started with your Raspberry Pi journey

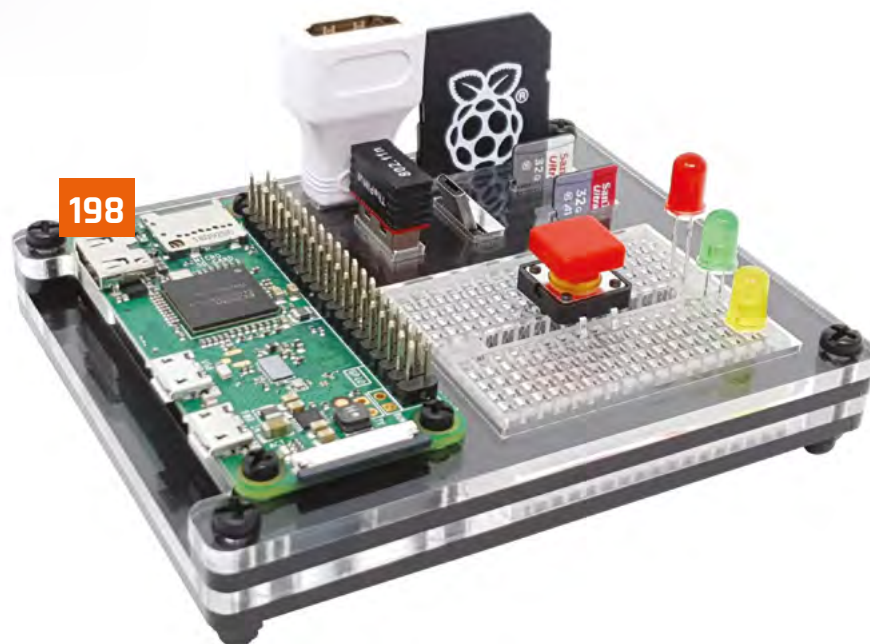

198



200

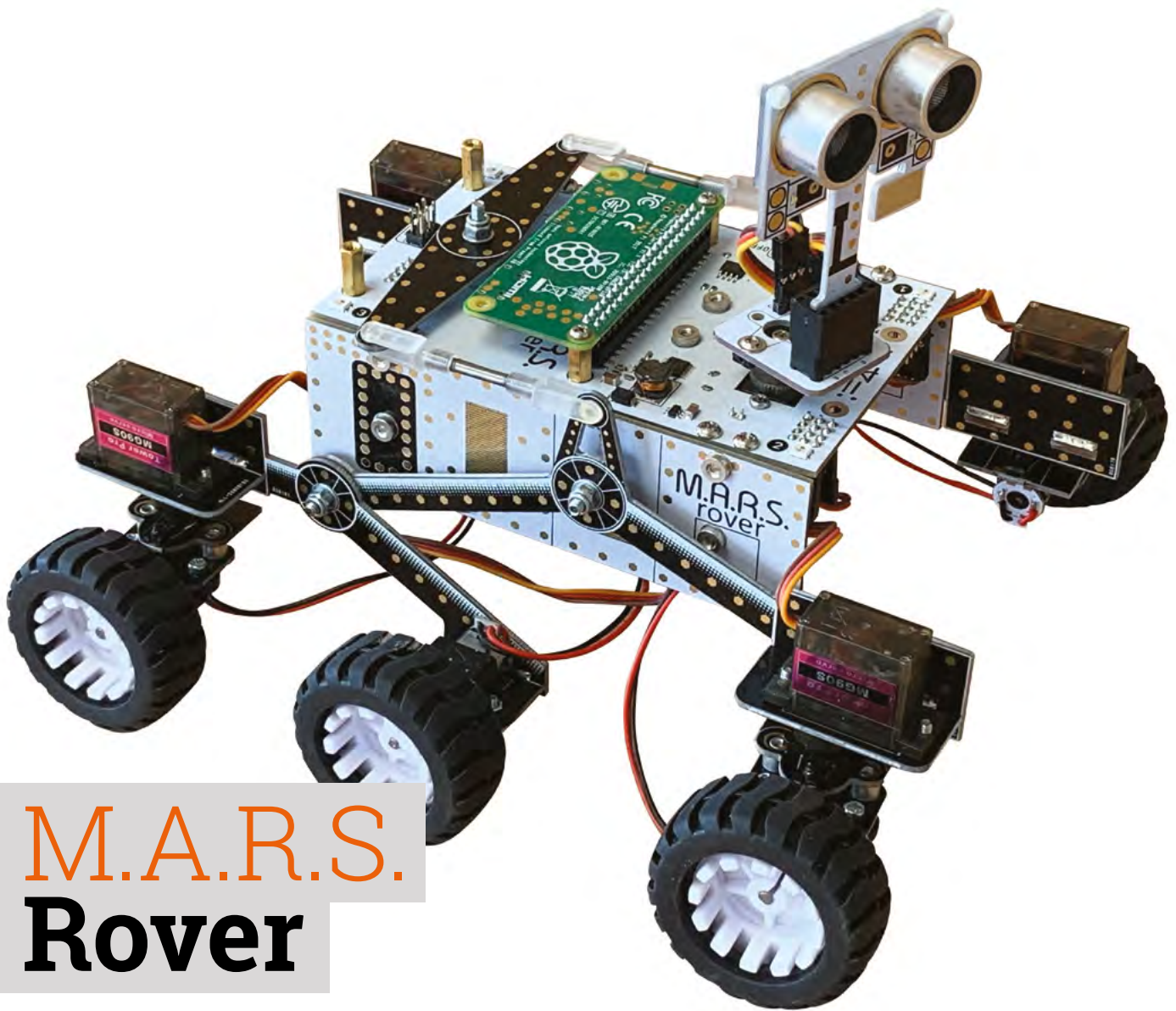

# M.A.R.S. Rover

► 4tronix ► [magpi.cc/marsrover](https://magpi.cc/marsrover) ► £120 / \$157

Explore new territory with this sophisticated six-wheeled robot kit. By **Phil King**

▲ This six-wheeled Rover even features a rotating mast with ultrasonic distance sensor

**A**s we don't have our own spaceship, we aren't be able to test out 4tronix's M.A.R.S. Rover on another world, but it's an impressive vehicle featuring six driven wheels, four of them steerable, and a unique suspension system.

With no fewer than three space missions heading for the 'red planet' in 2020-21, Mars is a hot destination right now. Traversing its rocky landscape will be two new rovers, including NASA's Perseverance Rover.

Like its predecessors, including Curiosity, Perseverance features a rocker-bogie suspension system that enables it to clamber over large rocks without tipping over. A similar system is used by

the 4tronix M.A.R.S. Rover, enabling it to tackle tough terrain. To help avoid larger obstacles and walls, the Rover features a rotating mast with ultrasonic sensor.

## Start building

Packed in a cardboard box, the kit features a large array of components, including six motors, five servos, and no fewer than 30 PCB shapes to create the structure. In large kits like these, finding the right components and tiny screws can be a pain, so it's a great help that they're sorted into ten plastic bags relating to each step of the assembly process.

The latter is detailed in an online guide featuring plenty of photos, making it easy to follow. Even

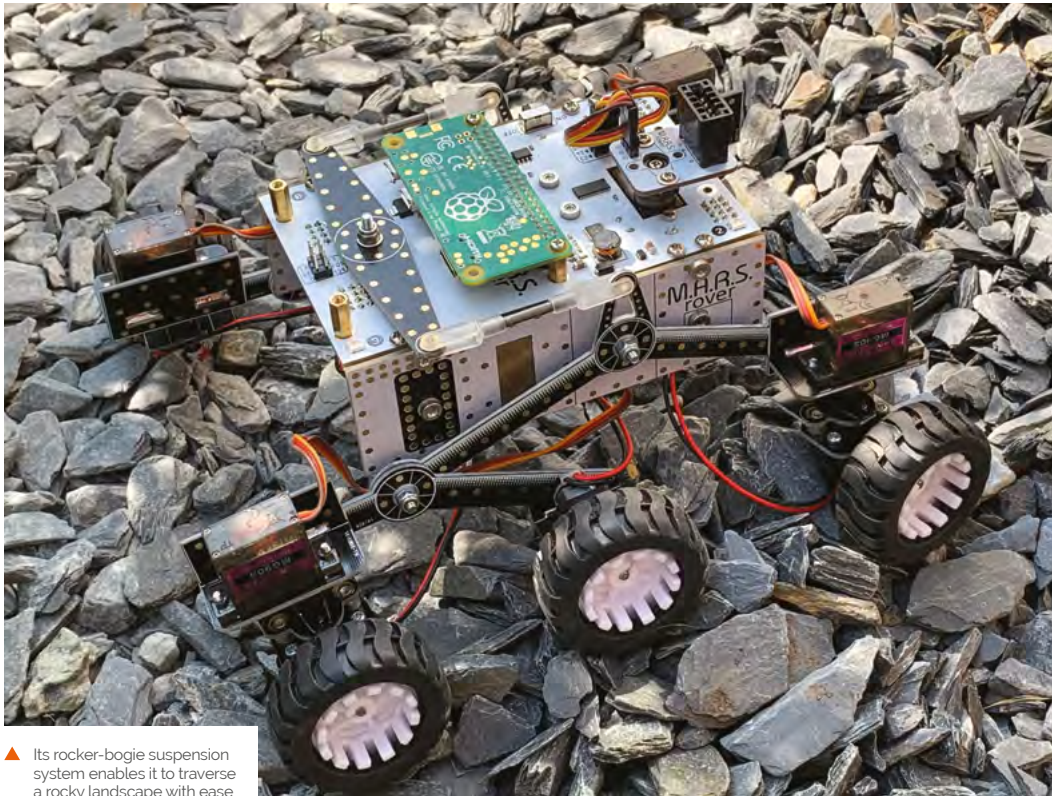

▲ Its rocker-bogie suspension system enables it to traverse a rocky landscape with ease

## SPECS

### MOTORS:

6 × 80 rpm 6V, N20 micro gear motors

### SERVO:

5 × MG90S metal gear analogue micro servos

### POWER:

4 × AA battery pack (batteries not supplied)

### FEATURES:

Ultrasonic distance sensor, RGB LEDs, white LEDs, rocker-bogie suspension

### DIMENSIONS:

200 mm (L) × 185 mm (W) × 170 mm (H, with mast)

so, you'll need plenty of time to build such a serious kit. 4tronix reckons it will take even an experienced kit builder around two hours; for others, you can at least double that time.

In the event, it took us several hours to assemble, partly due to an issue with screwing the bogies onto the rocker arms on either side using a small screw and nyloc nut. We found it impossible to screw it on tightly enough using the supplied mini screwdriver and spanner, so had to resort to using a larger, sturdier screwdriver.

Other than that hiccup, it was a fairly straightforward if lengthy process. Some of the PCB pieces have nuts pre-installed, which does make things a lot easier.

## Steering servos

Four servos are used to steer the front and rear wheels. A handy little ServoZero board is included to connect to the servos during assembly and set them to zero before attaching the horn and motor mount at approximately 90 degrees to the Rover's body. Fine adjustments may be made to the wheel alignment later in the software.

A differential system, connecting the rocker arms, keeps the rover body level as the wheels on one side or the other traverse uneven terrain.

Fitting the motors is easy enough, as each is pre-wired with a JST connector that fits into one of the ports on the main board.

With the main body and suspension system assembled, and chunky wheels attached, the final touch is to add a mast with an ultrasonic distance sensor to the top. This even has a servo so you can rotate it with code.

“Featuring six driven wheels, four of them steerable, and a unique suspension system”

## Rolling Rover

Insert four AA batteries (not supplied) in the holder at the bottom the main board and mount a Raspberry Pi Zero on top and you're ready to install the software. A Python library is accompanied by several code examples, including one that enables you to control the Rover remotely (via SSH) with your keyboard. There's also an example to test an optional keypad (£9/\$12) that fits onto the rear.

While the Rover moves at a fairly sedate pace, the steering servos allow it to turn quickly and more smoothly than with the typical tank steering on other wheeled robots. Best of all, that rocker-bogie suspension system enables it to roll over an obstacle, even when only one set of wheels is traversing it, with all six wheels magically maintaining contact with the ground – it's fascinating to watch in action and far superior to fixed-wheel buggies at handling difficult terrain. 📺

## Verdict

A little pricey, but this is a high-quality kit. The Rover looks cool and can traverse the toughest terrain with its six driven wheels, servo steering, and clever suspension system.

9/10

# SmartiPi Touch 2

▶ The Pi Hut ▶ [magpi.cc/smartipi2](http://magpi.cc/smartipi2) ▶ £24 / \$32

A very smart-looking case for the discerning touchscreen user.

**Rob Zwetsloot** puts one together for a test

**W**e feel like we slightly overlooked the original SmartiPi case, so we're happy to rectify this with the brand new SmartiPi Touch 2.

This case is designed to work with the 7-inch official Raspberry Pi touchscreen, effectively turning a Raspberry Pi into a (bulky) tablet or fixed monitor. As there's no real room for rechargeable batteries as standard, it works better in a more fixed environment.

“ You can choose little feet for the display, or a foldable stand ”

One of the unique features of the SmartiPi is the interchangeable faceplates on the front of the case. As well as allowing for a Raspberry Pi Camera Module to be mounted inside the case, it enables you to add a Lego-compatible plate. It's not large, so you can't do much with it, but it's a very neat addition nonetheless.

## Smart build

Construction is extremely easy, just requiring you poke some ribbon cables in the right place and fasten and tighten some screws to make sure everything is mounted properly. You can choose little feet for the display, or a foldable stand so you can angle the screen – both are easy to install and even replace. There's also a little case fan and vented rear panel to keep your Raspberry Pi cool.

It's extremely well thought out, and a very handy case if you need a compact 'Raspberry Pi with screen' solution that just looks nice. **M**

## Verdict

A great case if you need a stationary tablet, although making it mobile might be a little more tricky.

**8**/10



▲ It looks sleek and compact from the front



▲ The additional case fan and vents can be handy for intensive loads

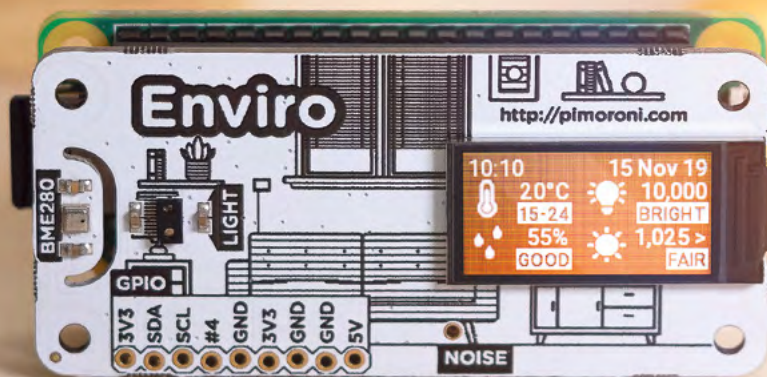

# Enviro

## SPECS

### BUILT-IN SENSORS:

BME280 temperature/pressure/humidity, LTR559 light/proximity, SPH0645LM4H-B noise

### DISPLAY:

0.96-inch colour LCD (160×80)

### DIMENSIONS:

65×30×8.5 mm

► Pimoroni ► [magpi.cc/enviro](http://magpi.cc/enviro) ► £28 / \$30

An environment-sensing board with a mini LCD screen to display data. By **Phil King**

**D**esigned for indoor monitoring, the Enviro board enables you to measure temperature, pressure, humidity, light, and noise levels.

While it lacks the gas sensor, ADC, and particulate matter sensor connector of the Enviro + Air Quality version (reviewed in *The MagPi* #83, [magpi.cc/83](http://magpi.cc/83)), it retains the cool mini LCD colour screen to display data – ideal when using your Raspberry Pi in a headless setup, without a monitor.

It also features the same slimline pHAT form factor to match the size of a Raspberry Pi Zero, although it can be used with any Raspberry Pi model.

## Sensing the world

The Enviro's BME280 weather sensor monitors temperature, barometric pressure, and humidity. As on the Enviro +, this has been positioned at the left edge of the board, away from Raspberry Pi's CPU, and there's even a little smile-shaped slot around it to help reduce heat radiated through the board. Even so, you'll need to adjust its temperature reading for accuracy (by measuring that of the CPU itself and deducting a factor of it).

A smartphone-style LTR-559 light and proximity sensor detects the ambient light level and also proves handy as a substitute for a push-button when you put your finger on it. The board's tiny MEMs microphone measures sound levels, useful for monitoring noise pollution, and can also be used to record audio.



▲ The rear of the board, showing the pre-soldered female GPIO header

At the time of writing, most of the code examples provided with the Python library ([magpi.cc/enviroGH](http://magpi.cc/enviroGH)) are aimed at the Enviro + Air Quality board. However, it's easy to edit the code for missing sensors from the all-in-one example to get it showing rolling graphs for temperature, pressure, humidity, and light level on the LCD. There are also a couple of examples that make use of the mic to plot noise levels and frequencies.

If you don't need to test air quality and just want a simple environmental sensor with a built-in display, the Enviro is ideal. The light sensor could also come in handy for use in IoT setups, such as to trigger your lights to come on when the light level falls below a certain level.

If you also require motion/direction sensing, the original Enviro pHAT is still available (albeit without the mini LCD). [M](#)

## Verdict

Lacks the gas sensor of the Enviro + Air Quality board, but features the same mini LCD screen to display your environmental data without a monitor.

# 8/10

# Argon Neo & Argon Fan HAT

## SPECS

### CASE:

Aluminium alloy, passive cooling, sliding magnetic top

### FAN:

40 mm cooling fan, status LEDs, power button

▶ Argon40 ▶ [argon40.com](http://argon40.com) ▶ £15 / \$15, Argon Neo case; £10 / \$10, Argon Fan

Argon40 makes some of the best cases for Raspberry Pi. We take a look at its new entry-level offering. By **Lucy Hattersley**

**A**rgon Neo is the latest case from Argon40, an impressive case maker which came onto everybody's radar last year following a successful Kickstarter campaign to build a high-quality case. The result was Argon One, which won our group test of thermal cases for Raspberry Pi ([magpi.cc/thermaltest](http://magpi.cc/thermaltest)).

The Argon Neo and Argon Fan HAT split the case and cooling system into two separate purchases. These fit together neatly to provide a single integrated solution.

Whereas the Argon One has a fan integrated into the lid and a breakout board to move connections

to the rear, Argon Neo surrounds the Raspberry Pi board and provides access holes for the original connections.

Alongside the fan, The Argon Fan HAT provides a power button, which can perform safe shutdown, forced shutdown, and reboot Raspberry Pi.

## Putting it together

As with other cases (such as Flirc, [magpi.cc/flirc](http://magpi.cc/flirc)), the metal part of the case connects to the CPU and RAM (with included thermal paste). The metal case acts as a passive heatsink.

A neat touch it shares with Argon One is the GPIO pin layout guide printed on the case. (Although with the Argon Fan HAT attached, half of the GPIO pins numbers are hidden behind the board.)

Unlike Argon One, you can also access Raspberry Pi's Display and Camera ports (the latter only

▼ The layers fit together to sandwich Raspberry Pi, and the metal case acts as a passive cooling system



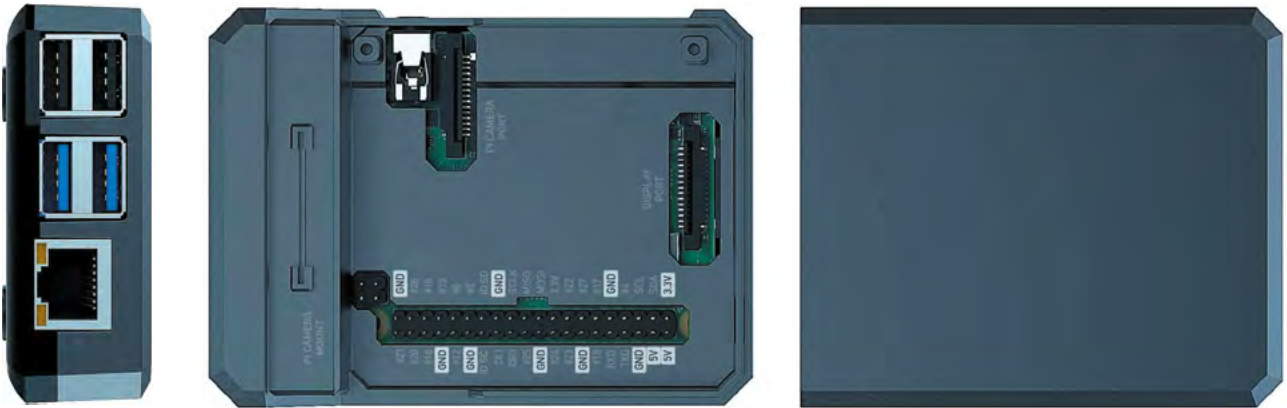

- ▼ Argon Neo is a stylish case with a lid that can be removed to break out the GPIO pins



- ▶ The Argon Fan HAT sits on top of Raspberry Pi and provides additional cooling at temperatures above 55°C



without the fan connected). When you're done with accessing ports and GPIO pins, the metal lid snaps the whole kit shut via a magnet to form a stylish metal case.

### Keeping it cool

The fan speed is related to the CPU temp, kicking in at 55°C and increasing to 100% fan speed at 65°C.

We stress-tested a Raspberry Pi 4 (4GB) CPU at full capacity for 15 minutes with both Argon Neo and Argon Fan HAT attached.

Things started at 37°C and the temperature slowly rose and hovered around 55°C, before the fan duly kicked in and held the temperature in check for the full 15 minutes, maxing out at 58°C.

We ran the same test with the Argon Neo case without the fan attached and found the temperature maxed out at 58°C – exactly the same temperature as with the fan attached.

None of this is anywhere close to threatening Raspberry Pi performance. As the CPU temperature approaches 85°C, Raspberry Pi OS throttles the CPU speed to bring down the temperature. Either with or without the fan, we didn't get anywhere near that temperature.

“ The whole thing snaps together into a stylish metal case ”

With that in mind, we overclocked our Raspberry Pi 4 to 2.0GHz ([magpi.cc/overclock](http://magpi.cc/overclock)) and reran the test. Without the fan, the temperature ran up to 82°C (and was kept in check by the passive cooling of the case alone). Still not enough for Raspberry Pi OS to begin throttling the CPU.

So, we are left wondering whether you actually need the fan?

### Which to buy?

It's \$15 for the Argon Neo case and \$10 for the Fan HAT, which makes the package the same price as the larger Argon One.

To its credit, the Argon Neo is a more minimalist design that's slimmer and more in keeping with the design aesthetic of Raspberry Pi. It's certainly a neat solution, and is cheaper if you opt for the Argon Neo case on its own. [📄](#)

## Verdict

We like this an awful lot, but we like the original Argon One case a little more. However, the Neo is stylish and cheaper if you opt for the case without the fan.

8/10

# RedBoard+

## SPECS

### MOTOR CONTROL:

2 × 6 amp H-bridges with fully proportional speed control

### CONNECTIONS:

13 × GPIO (plus power and ground), 4 × I<sup>2</sup>C, 3 × analogue inputs, 10-pin useful header

### POWER:

7V – 24V battery input, with reverse polarity protection

### FEATURES:

Four-channel ADC, four-channel 5V level shifter, power switch, programmable button, optional daughterboard, and OLED

► Red Robotics ► [redrobotics.co.uk](http://redrobotics.co.uk) ► £31 / \$40

A feature-packed robotics board with the ability to drive powerful motors. By **Phil King**

**W**hile there's no shortage of robotics controller boards available for Raspberry Pi, this one has two main selling points. Firstly, it boasts two really powerful motor drivers. Secondly, an astonishing number of features are crammed onto this full-size board – it seems its designer (Neil Lambeth of Red Robotics) has thought of everything you might need for a robotics project.

### Serious power

Two on-board H-bridges provide up to 6A of continuous current per channel to two motors, or two sets of motors, with fully proportional speed control. While there's no facility to independently control four motors, as on the ZeroBorg for example, this won't be a deal-breaker for most robot builders.

“ The input voltage for external power is 7V to 24V, so you have a wide range of options ”

Motors are connected via screw terminals, as is your external power source. The input voltage for this is 7V to 24V, so you have a wide range of options, from AA battery packs to LiPo cells – LiPo is recommended for driving big motors. For a good example of the kind of power it can deliver, with the right motors, check out Neil's test-drive of his four-wheeled robot zipping around a lawn at great speed: [magpi.cc/redboardtest](http://magpi.cc/redboardtest).

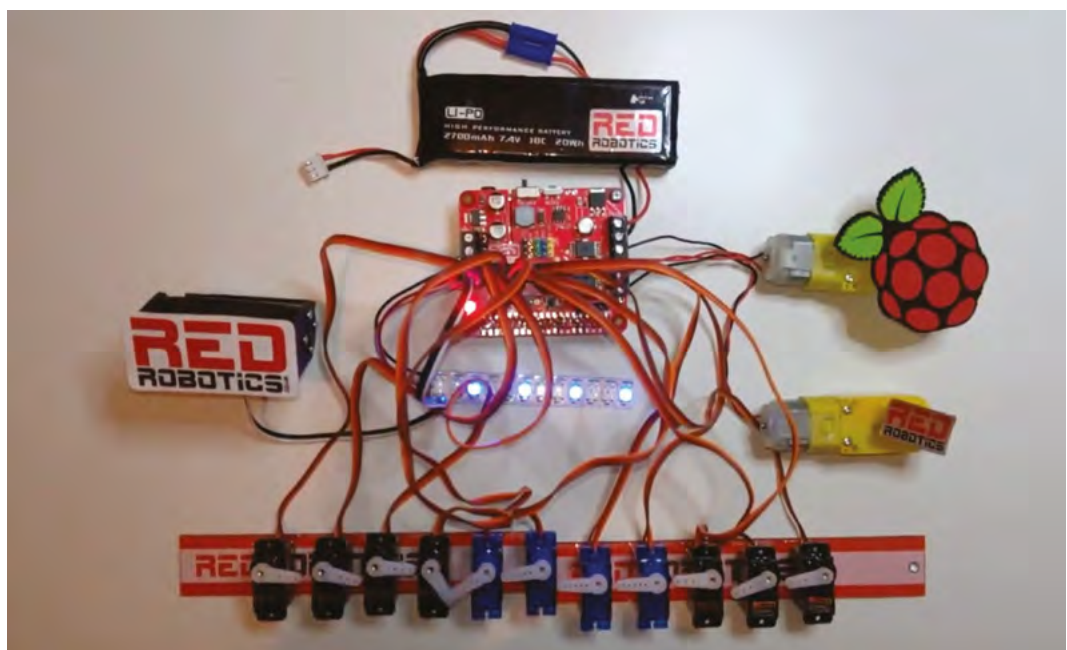

► A demo showcasing the RedBoard+'s multifunctionality with twelve servos, NeoPixels, and motors connected



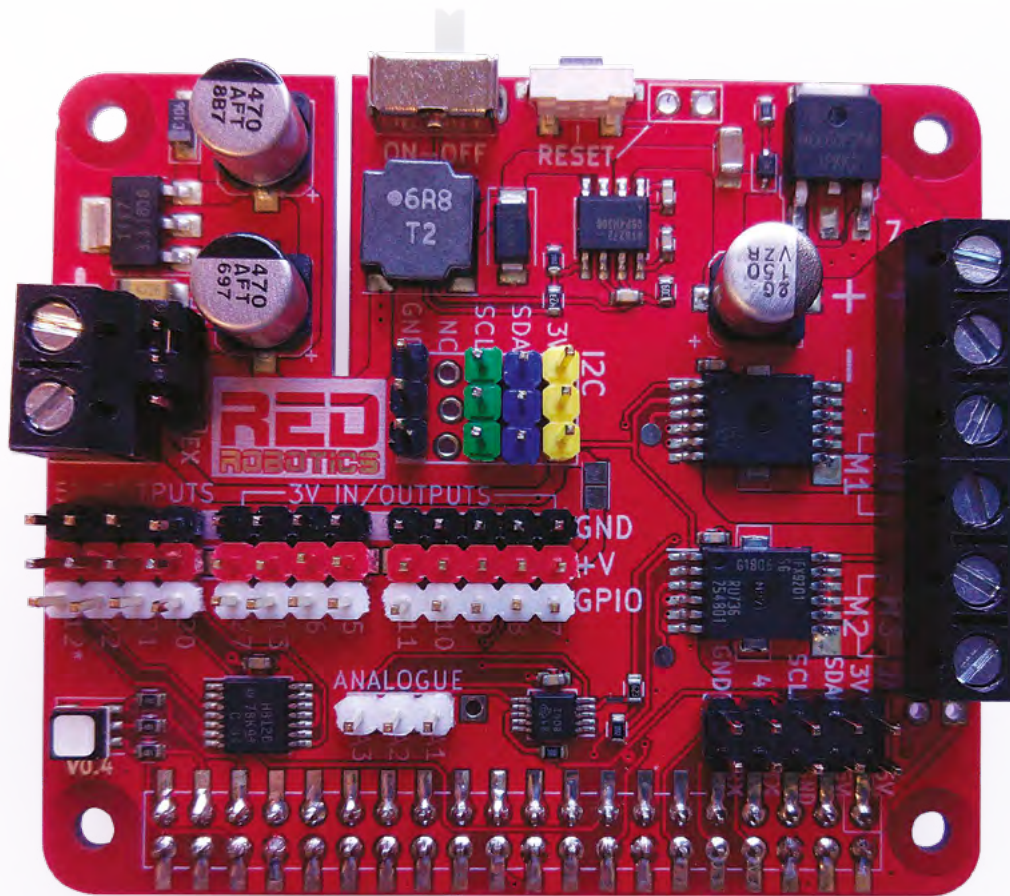

◀ A cornucopia of connectivity, the RedBoard+ has multiple breakout headers, including 5V outputs and analogue inputs

The external battery also powers your Raspberry Pi, RedBoard+'s on-board BEC delivering a steady 5.2V at 3A, which is enough for a Raspberry Pi 4.

One nice touch is the inclusion of a power switch to turn the battery power on and off. There's also a user-programmable push-button: by default it's set to reboot Raspberry Pi with a medium press, and shut it down with a longer press. A short press will cause an on-board RGB LED to flash repeatedly in red, green, blue to show the last number in the IP address – handy for SSHing in.

### Servo central

The RedBoard+ offers an impressive range of connectivity options. The main header breaks out 13 GPIO pins (including SPI, GPIO 7–11), with power and ground for each, so you can connect numerous servos and/or other electronics. Making use of an on-board voltage level shifter, four of the sets of pins offer 5V power, while the GPIO 12 pin can be used to control NeoPixels with PWM.

If you want to use larger 7.4V robot servos, there's an option to connect a separate power supply via two screw terminals, although this does set all the main header power pins to 7.4V.

The RedBoard+ also features a three-pin header for analogue inputs (up to 3.3V) using the on-board TI ADS1015 four-channel ADC – its other channel is dedicated to LiPo battery voltage monitoring.

That's not all! The board includes a header for four I<sup>2</sup>C channels, plus a ten-pin 'useful header' which breaks out I<sup>2</sup>C, Rx/Tx, 3.3V/5V power, and ground pins – this can be used with an optional daughterboard and mini OLED to show battery stats, IP address, etc.

### Software

Controlling everything is made easy using the Python software library – if you don't want to install it manually, there's even a preconfigured Raspbian image available. Plentiful code examples – including controlling various functions with a wireless gamepad – should help you get started, along with the detailed instructions on GitHub.

While RedBoard+ is probably overkill if you just want to drive a couple of standard low-power motors, it's an amazing feature-packed board. To get an idea of what it can really do, check out Neil's demo video showcasing the multifunctionality: [magpi.cc/redboarddemo](https://magpi.cc/redboarddemo). 

## Verdict

With its powerful motor drivers and huge range of connections for servos and electronics, we can see this becoming a favourite board used in events like Pi Wars.

# 10/10

# Unicorn HAT Mini

► Pimoroni ► [magpi.cc/unicornhatmini](https://magpi.cc/unicornhatmini) ► £20 / \$20

Light up your world with this mini multicoloured marvel. By **Phil King**

**B**uilding on the success of its Scroll HAT Mini board, which features a matrix of bright white LEDs, Pimoroni has launched the Unicorn HAT Mini: a multicoloured version with individually addressable RGB pixels.

It also carries the Unicorn branding, as seen previously on the original 8×8 Unicorn HAT, 16×16 Unicorn HAT HD, and supersize Ubercorn. This time the Zero-size board features a 17×7 matrix.

“The frame rate test averaged an impressive 67fps”

One slight downside is that – unlike the full-size Unicorn HAT HD – it doesn’t come supplied with a translucent diffuser layer to fill out the gaps in the display between the small pixels. However, you could always make your own, even out of paper.

## Push-button controls

Four programmable push-buttons – two on either side of the matrix – feel satisfyingly springy and responsive, while their input can be read using the standard GPIO Zero library.

Since the Unicorn HAT Mini uses different pixels and twin LED driver chips

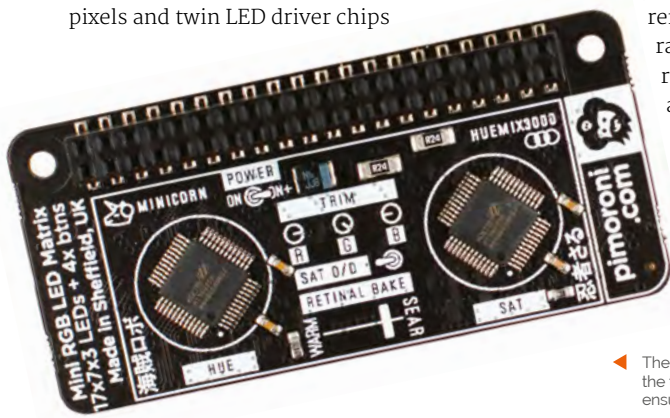

▲ A dazzling display from the matrix of individually addressable RGB LEDs

from the other Unicorn boards, examples and code written for those won’t run directly without a few tweaks to the code first.

Fortunately, Pimoroni has put together a special Python library for the Unicorn HAT Mini ([magpi.cc/unicornhatminigit](https://magpi.cc/unicornhatminigit)). Note that you’ll need to enable SPI manually (in Raspberry Pi Configuration > Interfaces ) to get it to work.

As well as enabling precise individual pixel control using RGB and brightness values, the library features eleven Python code examples to get you started. These include a nifty pixel shading demo, multicoloured scrolling text, and fun Simon and Columns to make use of the buttons. To give you an idea of how fast the matrix can be refreshed, an ‘fps’ example tries to do so as rapidly as possible while printing the frame rate to the Terminal – in our tests, it averaged an impressive 67fps.

Of course, you can always write your own code to do whatever you like with this versatile little board. Robin Newman has even managed to control its display using OSC messages from Sonic Pi: [magpi.cc/unicorsonicpi](https://magpi.cc/unicorsonicpi).

◀ The underside of the board reveals the two LED driver chips which ensure a fast refresh rate

## SPECS

**DISPLAY:**  
17×7 RGB matrix  
(119 LEDs)

**LED DRIVER CHIPS:**  
2 × Holtek  
HT16D35A

**INPUTS:**  
4 × tactile  
buttons

**DIMENSIONS:**  
65×30×10 mm

## Verdict

A versatile mini RGB LED matrix with bright pixels, a fast refresh rate suitable for animations, and the bonus of four programmable push-buttons.

9/10

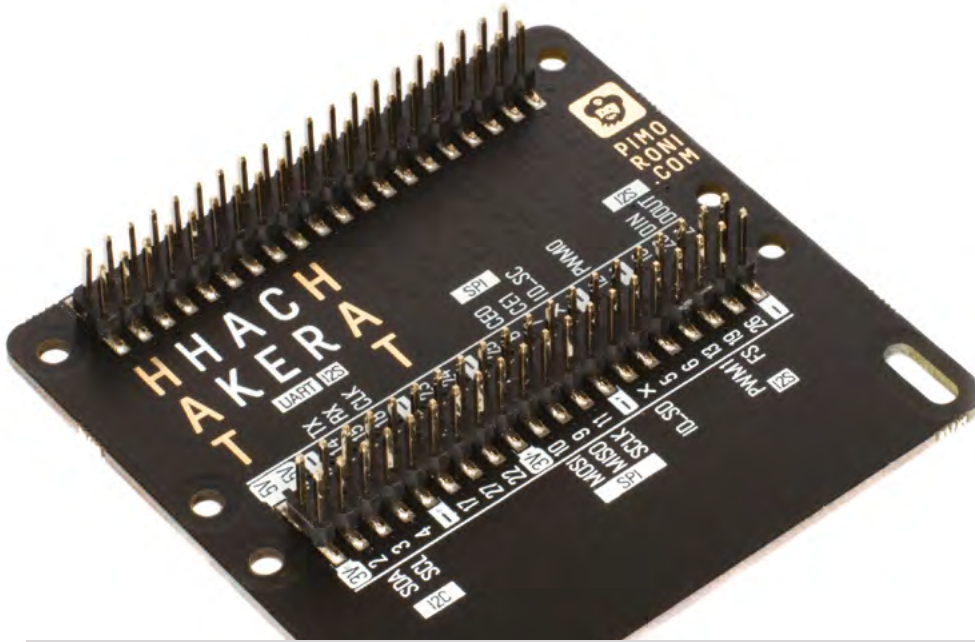

# HAT Hacker HAT

► Pimoroni ► [magpi.cc/hathacker](https://magpi.cc/hathacker) ► £9 / \$10

Enabling Raspberry Pi to wear two mini HATs. By **Phil King**

**W**ith two sets of 40 GPIO pins, the HAT Hacker HAT enables you to connect two mini HATs (aka pHATs) – or one mini HAT and one full-size HAT – to Raspberry Pi. It serves a similar function to Pimoroni’s earlier (and still available) Black Hat Hack3r, but rather than being connected via a ribbon cable, it is a HAT itself and so mounts directly on Raspberry Pi’s GPIO header.

Supplied fully assembled, it’ll work with any 40-pin Raspberry Pi model. Pimoroni has thoughtfully included six metal PCB standoffs (with screws) for spacing and securing it, and/or the attached mini or full-size HATs, via pairs of the eight mounting holes provided.

## Pin checking

No extra software is required. So, in theory, you just mount your two mini HATs on the HAT Hacker HAT and you’re all set to go. Well, you do need to check that the same pins aren’t used by both HATs (unless they’re I2C pins with different addresses), which is easily done by looking them up on [pinout.xyz](https://pinout.xyz) – or using the pHAT Stack Configurator ([pinout.xyz/phantstack](https://pinout.xyz/phantstack)), although the latter offers a limited selection of HAT and pHAT options supplied by Pimoroni.

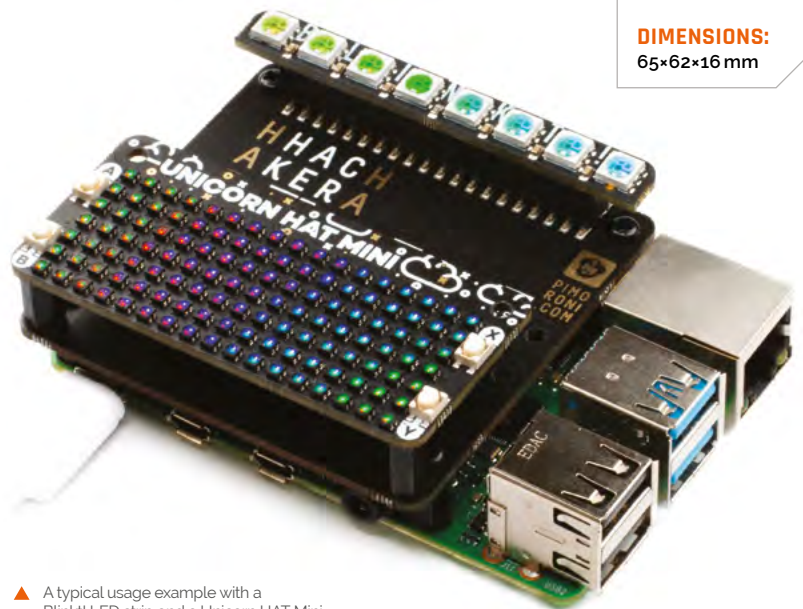

▲ A typical usage example with a Blink! LED strip and a Unicorn HAT Mini

If you need to attach more than two HATs to Raspberry Pi, a pHAT Stack ([magpi.cc/phantstack](https://magpi.cc/phantstack)) would be a better option, as you can attach up to five mini HATs or three full-size HATs.

For most project setups, however, the HAT Hacker HAT should suffice. You might well want to connect just one mini HAT, e.g. a display, and use the other set of pins for connecting electronic components – for which the full labelling of the second header’s pins is very useful. Unlike the similar FullpHAT ([magpi.cc/fullphat](https://magpi.cc/fullphat)), however, there are no bonus GPIO breakout holes in addition to the two main headers. **M**

◀ With two 40-pin male headers, you can mount two mini HATs, or one mini HAT and one full-size one

## SPECS

**CONNECTIONS:**  
2 × 40-pin male headers for mounting two mini HATs

**FIXINGS:**  
6 × black metal PCB standoffs, 12 × screws

**DIMENSIONS:**  
65×62×16 mm

## Verdict

A compact and solidly built solution to mounting more than one mini / full-size HAT on Raspberry Pi at a reasonable price.

**8/10**

# RetroFlag GPi Case

## SPECS

### DIMENSIONS:

138×81×32 mm

### WEIGHT:

138 g

### DISPLAY:

2.8-inch IPS

### POWER:

3 × AA batteries  
or USB

### COMPATIBILITY:

Raspberry Pi Zero  
or Zero W (not  
Zero WH)

► The Pi Hut ► [magpi.cc/gpicase](https://magpi.cc/gpicase) ► £60 / \$79

**PJ Evans** takes retro gaming on the go with this eighties-handheld-inspired case with screen

**I**f you're serious about retro gaming and would like to be able to play all the games in all the places, the RetroFlag GPi case might just be your new best friend. More than a simple enclosure for the Raspberry Pi Zero, this rather familiar-looking unit is a full-blown battery-powered gaming console that (just about) fits in the palm of your hand.

## Game on

The clever design of the GPi replicates that of eighties handheld consoles, including a cartridge-like unit that slides out of the rear and is quickly disassembled to reveal space for a Raspberry Pi Zero. A very neat 'pogo' mounting system means no header or soldering is required: a Raspberry Pi Zero just slots in and pressure maintains the contacts. The reassembled unit then slots into the main body and you're ready to go. You can even access the microSD card without removing the 'cartridge'. Power is supplied by three AA batteries or a supplied USB cable.

Full and clear instructions are provided to install support for the gamepad buttons and also the on/off switch that provides easy and safe shutdown. We found the unit easy to assemble and had RetroPie running in no time at all. We were particularly impressed by the screen, which uses IPS rather than TFT to give a razor-sharp display from any angle without any of the common side-lighting issues. A small audio speaker is built-in, with the option of headphones. The case itself is injection-moulded, solid, and beautifully made. **M**

▼ Although bulky like classic 1980s handhelds, it feels comfortable in hand and the controls are well-placed



## Verdict

This is one of the best gaming cases we've seen. A great design, easy assembly and, most of all, great fun to use. An essential purchase for any retro gamer.

# 10/10



# Maker pHAT

## SPECS

### ON-BOARD COMPONENTS:

Active buzzer,  
3 × push-buttons,  
8 × blue LEDs

### BREAKOUT:

Fully labelled 24-pin header, plus stacking header

### REMOTE CONNECTION:

USB to serial module

► Cytron ► [magpi.cc/makerphat](http://magpi.cc/makerphat) ► £8 / \$10

A board to help beginners get started with physical computing. By **Phil King**

**W**hen trying to learn how to use and program electronics with Raspberry Pi, learners – whether in a classroom setting or at home – face some typical problems.

First, you need access to a keyboard and monitor. Second, there's the sometimes tricky business of attempting to create electronic circuits from separate components without getting it wrong and the possibility of 'magic smoke'. Then, if your project doesn't work, it's hard to tell whether it's because your wiring or code isn't right, or maybe both. This isn't helped by the difficulty of identifying the correct GPIO pins on Raspberry Pi, as they're unlabelled.

Cytron's Maker pHAT attempts to solve these issues and make it a lot simpler to get started with physical computing on Raspberry Pi.

### Purple PCB

The cool-looking purple PCB has some common components already on board and connected to



▲ The board is the perfect size for mounting on a Raspberry Pi Zero, although stand-offs aren't included

certain GPIO pins. Along with three small push-buttons, there's an active buzzer and eight tiny LEDs – we were slightly disappointed that they're all blue and not a range of colours. A nice touch is the inclusion of a fully labelled, 24-pin breakout header for connecting external components when you're done playing with the on-board ones.

While you can simply mount the board on your Raspberry Pi's GPIO header – with or without the supplied 40-pin stacking header – and start coding, the pièce de résistance is the inclusion of a USB to serial module. This enables you to connect the board to a laptop and control (and power) it and Raspberry Pi remotely from there, eliminating the need for a separate monitor and keyboard.

A comprehensive online manual ([magpi.cc/makerphatinfo](http://magpi.cc/makerphatinfo)) explains how to install a special driver and get the serial connection working using PuTTY on Windows, though not on a Mac. For the latter, use Terminal and enter `ls /dev/cu.usbserial-*` to find the device number, then `screen /dev/cu.usbserial-XXXXXXXX 115200 -L` to log in (after pressing **ENTER** repeatedly). The manual includes a Python demo program, which makes use of GPIO Zero, to get you started – it even enables you to safely shut down Raspberry Pi by pressing two of the buttons together. 

## Verdict

An inexpensive and well-designed board for physical computing newbies. We particularly like the option to control it from a USB-connected laptop.

# 9/10



▲ The supplied stacking header provides full GPIO breakout and can be used to elevate the board on a full-size Raspberry Pi

# 10 Best: Raspberry Pi cases

Keep your Raspberry Pi safe with these amazing cases

**W**hen you love something, you want to protect it. We love our Raspberry Pi, so it seems natural to get a case for it to make sure it lives a safer life. We've seen a ton of cases over the years, with a massive variety of functionality. Here are ten of our favourites. [M](#)



## ▲ Official Raspberry Pi 4 case

### Official and classy

Simple and sleek, the official case is your go-to protector for a Raspberry Pi. The version for Raspberry Pi 4 is no different, and also comes in a lovely black and grey combination.

£5 / \$8 | [magpi.cc/pi4case](https://magpi.cc/pi4case)

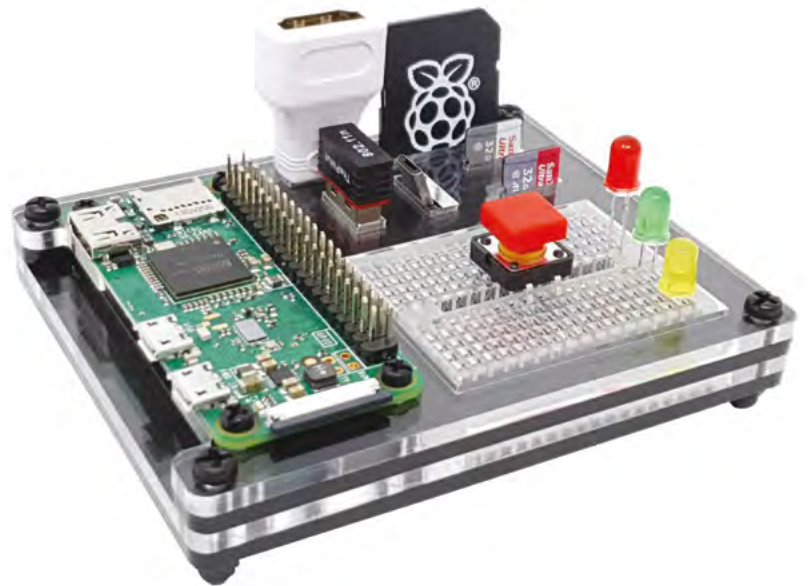

## ▲ ZeroDock

### Stay organised

Keeps your Raspberry Pi Zero safe? Check. Access to all its ports? Check. Ability to keep all your important components neatly stowed next to it? Double check.

£10 / \$13 | [magpi.cc/zerodock](https://magpi.cc/zerodock)

## ► Pibow Coupé

### Stackable protection

The original Raspberry Pi case reimaged for Raspberry Pi 4. You'll now only find the Coupé version, as it uses far less plastic and makes it easy to add HATs and other accessories.

£9 / \$10 | [magpi.cc/pibow](https://magpi.cc/pibow)

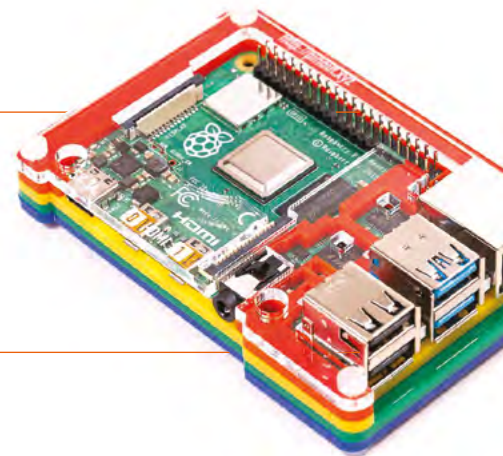

## ▼ Argon ONE



### Keep it cool

The winner of our thermal management case group test for Raspberry Pi 4, the Argon One case makes your Raspberry Pi look like a futuristic supercomputer.

£25 / \$32 | [magpi.cc/argonone](https://magpi.cc/argonone)



## ▲ SUPERPi Case

### Console conversion case

As well as being a nice-looking case, it allows you to redirect ports to appropriate locations, enabling you to plug USB controllers into the front, like on the original console.

£30 / \$38 | [magpi.cc/superpi](http://magpi.cc/superpi)

## ► Zebra Zero Plus

### Easy prototyping

While it does create a much larger footprint than a Raspberry Pi Zero on its own, it makes circuit creation nice and easy, with clearly labelled GPIO pins and an integral breadboard.

£10 / \$13 | [magpi.cc/zebrazero](http://magpi.cc/zebrazero)

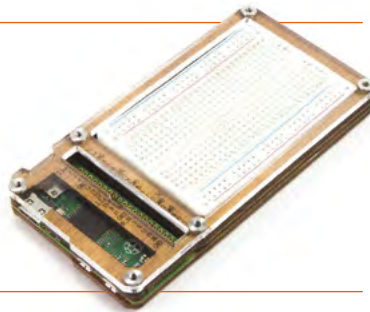

## ▼ FLIRC case

### Stylish media enclosure

These FLIRC cases are a great, sturdy enclosure with a media PC use in mind. The version for Raspberry Pi 4 has great heat-dissipating abilities as well.

£13 / \$17 | [magpi.cc/flirczero](http://magpi.cc/flirczero)



## ▲ SecurePi

### Maximum security

This is probably more for enterprise use, but if you're concerned about the physical security on your Raspberry Pi, being able to lock off the ports on this case is a great addition.

£10 / \$11 | [magpi.cc/securepi](http://magpi.cc/securepi)



## ▲ SmartiPi Touch 2

### Screen base, Lego beginnings

This case allows you add a touchscreen to a Raspberry Pi, while also providing a stand for it to stay upright. There are Lego add-ons you can use to make it extremely fun as well.

£24 / \$31 | [magpi.cc/smartistip2](http://magpi.cc/smartistip2)



## ▲ Aluminium Heatsink Case

### Cool speed lines

This cool-looking case will help keep your Raspberry Pi cool. It also comes in several excellent colours (we like the purple), so it should fit any mood.

£12 / \$13 | [magpi.cc/alumheatsink](http://magpi.cc/alumheatsink)

## PRINT YOUR OWN!

None of the cases above catching your eye? 3D-printing a Raspberry Pi case is always an option. Taking one from Thingiverse ([thingiverse.com](http://thingiverse.com)) and printing it, or doing a quick mod in Blender, is a great way to personalise your enclosure.

# 10 Best: Starter kits

Get started with your Raspberry Pi journey

**W**hether you've got a Raspberry Pi or not, it can sometimes be tricky to figure out where to start. There's a whole host of starter kits for people new to Raspberry Pi – here are ten of our favourites. [M](#)



## ▲ Official Raspberry Pi Desktop Kit

### Everything you need

The official kit comes with a Raspberry Pi, an official keyboard and mouse, an official power supply, an official case, and *The Official Raspberry Pi Beginner's Guide* book, all in one neat little package.

£117 / \$120 | [magpi.cc/desktopkit](http://magpi.cc/desktopkit)



## ▲ Pirate Radio

### Internet and sound

This cool kit from Pimoroni is not only a neat little portable internet radio, it's also a great way to learn about basic internet usage and connecting sound to a Raspberry Pi Zero.

£43 / \$47 | [magpi.cc/pirateradio](http://magpi.cc/pirateradio)

## ▶ CamJam EduKit 3

### Robots for beginners

We talk about this kit a lot, but for good reason – it's a fantastic (and cheap) jumping off point for learning about Raspberry Pi robotics. There are also some nice 3D-printable chassis for it.

£18 / \$23 | [magpi.cc/edukit3](http://magpi.cc/edukit3)



## ◀ AIY Vision Kit

### Updated sequel

This kit is a partner to the Voice Kit, and does image recognition using AI. We've seen some fun stuff made with image recognition, and this kit is very hackable once you've learnt all about it.

£83 / \$110 | [magpi.cc/aiyvision](http://magpi.cc/aiyvision)





## ▲ CamJam EduKit

### Electronics for beginners

This little kit will help you get started with electronics and digital making. It includes a breadboard, basic components, and jumper wires, and comes in a handy pocket-size tin for taking to Raspberry Jams.

£5 / \$7 | [magpi.cc/camjamkit](http://magpi.cc/camjamkit)

## ▶ AIY Voice Kit v2

### Updated classic

You may remember this from the cover of issue 57 of *The MagPi* – this updated version comes with its own Raspberry Pi Zero WH, and can help you get started with cool voice control.

£46 / \$60 | [magpi.cc/aiyvoice](http://magpi.cc/aiyvoice)



## ◀ Retro Gaming Kit

### Get gaming

Everything you need to start doing some retro gaming with Raspberry Pi – including a Raspberry Pi itself! Check over our previous issues (and this one) for tips on how to play retro games with Raspberry Pi.

£88 / \$115 | [magpi.cc/gamingkit](http://magpi.cc/gamingkit)



## ▲ Picade Console

### Arcade-style gaming

A smaller version of the full Picade, this is more like a plug-and-play gaming device. You just need to add a TV and you'll be straight back to the arcades of the late eighties.

£75 / \$82 | [magpi.cc/picadeconsole](http://magpi.cc/picadeconsole)



## ◀ OctoCam

### Sticky camera

This cute kit includes a Raspberry Pi Zero W, 5MP camera, and acrylic mount/stand. Have it guard your room or look out your window, thanks to its trademark cephalopodic suction arms.

£43 / \$47  
[magpi.cc/octocam](http://magpi.cc/octocam)

## ▶ Raspberry Pi 4 Starter Kit

### Simpler starter kit

This smaller, simpler, and cheaper starter kit from The Pi Hut includes some basic accessories such as an HDMI cable, power supply, case, and a microSD card so you can get started with what you have.

From £59 / \$77  
[magpi.cc/pihutstarter](http://magpi.cc/pihutstarter)





# Building your skills

Practice makes perfect, but working your way up to a big project is just as important, according to **Rob Zwetsloot**

**I**n my circles of Twitter, I see about once or twice a year a joke that goes something like ‘What do you mean I have to work at something to be better at it?!’ It’s part of the ‘relatable content’ subgenre of jokes that my generation like to tell, in this case a vocalised realisation presented as fake outrage. I do find it relatable as well – my attention can easily wane if I’m not immediately good at something, even if it’s something I enjoy doing.

Now, generally there are socio-political factors involved with some of this which boil down to your brain thinking ‘if you can’t do it well, it’s not worth doing because capitalism’, which far smarter people than me have written about at length. In the case of digital making and coding and building, it’s definitely worth understanding that beyond practice, there’s learning multiple different skills. And that feels a little more agreeable to the ol’ brain gremlins.

## One project at a time

As well as the tutorials I sometimes write for *The MagPi*, I also have buildery/codery hobbies such as making robot model kits and creating games. I currently have big, lofty

aspirations for what I can accomplish in both of these areas; however, I’ve fast come to the realisation that I’m not going to be achieving them quickly. This custom Gundam robot I’d like to make requires painting, weathering, customisation, kit-bashing, and more. Each of which is its own skill that I need to work on.

“ Treat yourself and leave some time free to make something just for fun ”

In this case, I’m able to build other kits – something I enjoy anyway – and maybe practise the painting aspect this time or have a go at weathering on the next kit.

It’s the same with digital making, with coding, wiring, woodwork, 3D printing, and more that you may need to work on separately before combining it all together to do, well, whatever it is you want. Robot obstacle course? A fully automated house? Fire-breathing dragon van? It’s all possible.

## Doing things for fun

Beyond that, it doesn’t matter if you have a big goal to work towards.

In times like these, I think it’s very important to remember that

sometimes you can just make or do stuff because you’d like to. Creative outlets and hobbies come in all shapes and sizes, including digital making, and can be so rewarding. I created a little scrolling countdown clock using an 8×8 LED screen once, just because I wanted to see if I could. It was quite simple (thank you, GPIO

Zero) and a bit of fun to make at the same time. I ended up modifying it and using it as a proper countdown clock, but that doesn’t always have to be the outcome.

So treat yourself and leave some time free to make something just for fun. Upload it to the internet if you want. As long as you’re feeling fulfilled by the end of it, that should be all you need. 

## AUTHOR Rob Zwetsloot

Rob is amazing. He’s also the Features Editor of *The MagPi*, a hobbyist maker, cosplayer, comic book writer, and extremely modest.

[magpi.cc](http://magpi.cc)

# Raspberry Pi goes industrial

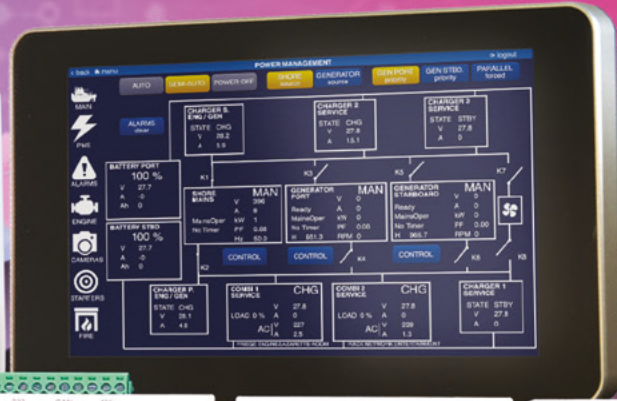

Long term availability, high reliability and support

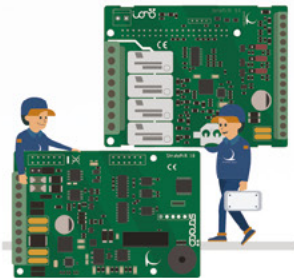

## Tailor-made embedded solutions

Our range of Raspberry Pi-based devices is wide. Really wide. But what if your project needs something more? We can put all of our expertise into your custom OEM design. Don't hesitate to contact us to explore every possibility!

Visit our website [www.sferalabs.cc](http://www.sferalabs.cc)



THE *Official*

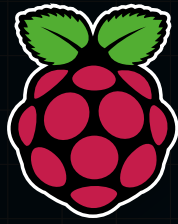

# RASPBERRY PI HANDBOOK

2021

Raspberry Pi is loved the world over by educators and makers thanks to its small size and endless possibilities. To help you get the most out of your Raspberry Pi computer, this official Handbook features 200 pages of essential information, inspiring projects, practical tutorials, and definitive reviews.

## 200 PAGES OF RASPBERRY PI

- Learn how to set up your Raspberry Pi and start using it
- Discover the new Raspberry Pi 400 and High Quality Camera
- Be inspired by incredible projects made by other people
- Learn how to code and make with our step-by-step tutorials
- Find out about the top kits and accessories for your projects

