

50 PROJECTS FOR MAKERS & HACKERS



BOOK OF MAKING VOLUME 1

FLY YOUR OWN
CUSTOM DRONE

BUILD AN
A.I. WATER CANNON

CONTROL YOUR HOME:
SMART TECH YOUR WAY

& LOTS
MORE

BUILD A
TREBUCHET

MAKE MUSIC
ON A DIY SYNTH

COOK FOOD IN A
HOMEMADE TANDOOR

FROM THE MAKERS OF **HackSpace** MAGAZINE



Find **hundreds** more books and magazines in the

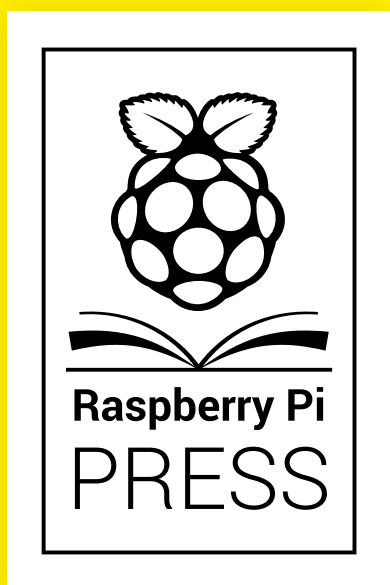

STORE



hsmag.cc/store





Welcome to The Book of Making

Every month, HackSpace magazine scours the makersphere for the best projects and the most useful skills. In this book, we've collected our favourite projects from the first year of HackSpace magazine. We know that not everyone has as much time as they'd like for these projects (actually, does anyone have enough time?), so we've split them up to help you fit a project into the time you've got. Are you trying to just squeeze something into

**Whether you're looking to get to grips with
woodwork, or heating up the soldering iron
ready to let the electronics flow, you'll
find something to get stuck into**

an hour, an afternoon, or have you got a spare weekend? Just flip to the appropriate section and you'll find plenty of inspiration.

Whether you're looking to get to grips with woodwork, or heating up the soldering iron ready to let the electronics flow, you'll find something to get stuck into. What are you waiting for? It's time to start building something.

BEN EVERARD

Editor @ben.everard@raspberrypi.org

Got a comment, question or thought about HackSpace magazine?

get in touch at hsmag.cc/hello

GET IN TOUCH

✉ hackspace@raspberrypi.org

f [hackspacemag](#)

📺 [hackspacemag](#)

ONLINE

📱 hsmag.cc



EDITORIAL

Editor

Ben Everard

✉ ben.everard@raspberrypi.org

Features Editor

Andrew Gregory

✉ andrew.gregory@raspberrypi.org

Book of Making Production Editor

Phil King

DESIGN

Critical Media

📧 criticalmedia.co.uk

Head of Design

Lee Allen

Designer

Mike Kay

Photography

Brian O'Halloran,

Fiacre Muller

Cover logo crafted by

Alex Eames

CONTRIBUTORS

Chris Ball, Jen Botezat, Andy Clark, Eric Coates, Jeremy S Cook, Jason Cram, Alex Eames, Jack Edjourian, Tanya Fish, David Floyd, Paul Freeman-Powell, Will Kalif, Andrew Lewis, Jenny List, Ashraf Minhaj, Goli Mohammadi, Carolyn Ryves, Bruno Santos, Mayank Sharma, Josh Tulberg, Mihir Vardhan, Loek Vellekoop, Nick Watson, Sophy Wong

PUBLISHING

Publishing Director

Russell Barnes

✉ russell@raspberrypi.org

DISTRIBUTION

Seymour Distribution Ltd

2 East Poultry Ave,

London EC1A 9PT

📞 +44 (0)207 429 4000

SUBSCRIPTIONS

Mann Enterprises Ltd,

Unit E, Brocks Business

Centre, CB9 8QP

📧 hsmag.cc/subscribe



This book is printed on paper sourced from sustainable forests. The printer operates an environmental management system which has been assessed as conforming to ISO 14001.

Book of Making is published by Raspberry Pi (Trading) Ltd., Station Road, Cambridge, CB1 2JH. The publisher, editor, and contributors accept no responsibility in respect of any omissions or errors relating to goods, products or services referred to or advertised. Except where otherwise noted, content in this book is licensed under a Creative Commons Attribution-NonCommercial-ShareAlike 3.0 Unported (CC BY-NC-SA 3.0). ISSN: 2515-5148.

Contents



78

06

ONE HOUR

- 08 CheerLights**
Tweet to change the colour of your LEDs
- 10 Neon sign**
Create a motion-sensing sign lit up with EL wire
- 16 Near-field communication**
Use NFC technology to create spell-binding projects
- 20 Light-up hat**
Sew LEDs into a woolly hat using conductive thread
- 22 Tropical terrarium**
Create a circular ecosystem in a jar and watch it grow
- 26 Cheese press**
Build your own wooden press to make tasty cheese
- 30 Tandoor oven**
Use clay pots to build an oven and cook great food on it

36

AFTERNOON

- 38 Smart letterbox**
Get push notifications to find out when your postie's been
- 44 Sonoff switches**
Turn devices on and off with these smart WiFi switches
- 50 Arduino synth**
Make your own 8-bit synthesizers with Arduino
- 56 Music box**
Build a touch-activated music box with no coding required
- 60 Silver-soldered storage box**
Protect your tools from rodents with this metal box
- 66 Dremel table saw**
Upgrade your multi-tool to make perfect straight cuts
- 70 Laser-cut turntable**
Create 360° animated GIFs with this geared turntable



26

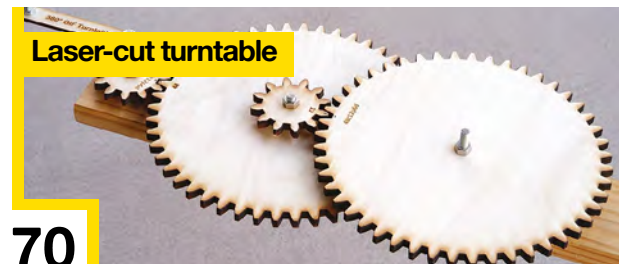

70

76

WEEKEND



30



108

- 78 Build a drone**
The ultimate guide to making your own quadcopter
- 92 AI robot sentry**
Create a smart sprinkler to guard your garden
- 98 Half adder**
Make things add up with this electronic circuit
- 104 Knife handle**
Craft a super-sleek knife handle with deer antler
- 108 Trebuchet**
Storm the castle with this miniature siege engine



Chicken coop opener

136

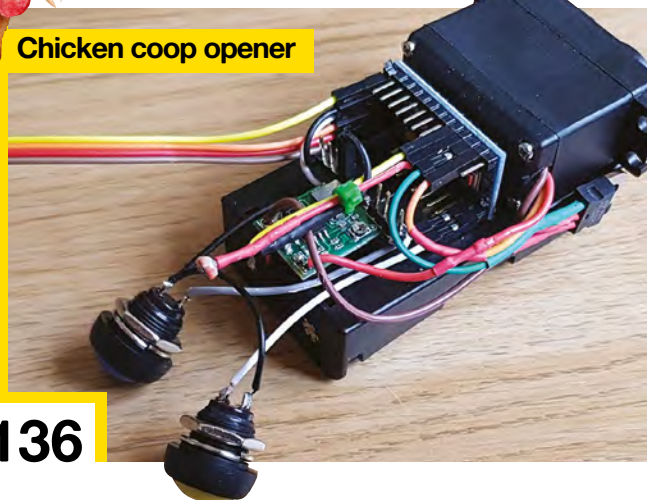

112

INSPIRATION

- 114 Duct tape**
No toolbox should be without this ubiquitous fix-all
- 118 Matchsticks**
Fun projects to make with a box of matchsticks
- 122 Hot glue**
Bind all kinds of projects with this versatile fastener
- 126 Paper clips**
They can do far more than hold pieces of paper together
- 132 Raspberry Pi reading glasses**
Equipped with a camera, they can read text out loud
- 136 Chicken coop opener**
A light-sensing smart door for farmyard animals
- 140 Rocket Launcher Strandbeest**
This amazing walking robot fires rockets
- 146 Manchester robot orchestra**
Almost anything can become a robotic instrument
- 150 Glass-blowing**
How to make a multicoloured glass bauble
- 156 Making a leather belt**
Keeping our trousers up the hacker way



102

Top Projects

- > 14 SunGlassBOT**
Robotically controlled smart sunglasses
- > 24 Wood bike**
Its frame is made from plywood
- > 54 Waterwheel pump**
Obtaining free power from a river
- > 74 Face-shooting robot**
Watch out: it has you in its sights
- > 102 Rapid Whale Mini Boat**
Take a seat in this stunningly small craft
- > 130 White Rabbit Nixie clock**
Precision-engineered with old-school looks
- > 144 Trash instruments**
Making music from recycled parts
- > 162 Bike trailer**
A mini caravan for a cyclist to tow

164

REVIEWS

- 166 Circuit Playground Express**
Versatile microcontroller for physical computing
- 168 SparkFun Inventor's Kit v4**
Ideal for anyone getting started with electronics
- 170 Brown Dog Crazy Circuits**
Helping young makers learn basic electronics
- 172 Stirling engine buggy**
Building a simple external combustion engine
- 174 Hydroponics**
The quick and easy way to get a fresh salad
- 176 Laser harp**
Play tunes with a flick of your finger

170



Some of the tools and techniques shown in this book are dangerous unless used with skill, experience and appropriate personal protection equipment. While we attempt to guide the reader, ultimately you are responsible for your own safety and understanding the limits of yourself and your equipment. Book of Making is intended for an adult audience and some projects may be dangerous for children. Raspberry Pi (Trading) Ltd does not accept responsibility for any injuries, damage to equipment, or costs incurred from projects, tutorials or suggestions in this book. Laws and regulations covering many of the topics in this book are different between countries, and are always subject to change. You are responsible for understanding the requirements in your jurisdiction and ensuring that you comply with them. Some manufacturers place limits on the use of their hardware which some projects or suggestions in this book may go beyond. It is your responsibility to understand the manufacturer's limits.

ONE HOUR PROJECTS

HACK | MAKE | BUILD | CREATE

For when you don't have a great deal of spare time, these projects are quick to make – have fun!

Top Projects – Showcase

SunGlassBOT

PG
14



PG
8

CHEER LIGHTS

Tweet to change the colour of your LEDs, and everyone else's

PG
10

NEON SIGN

Create a motion-sensing sign lit up with glowing EL wire



Wood bike

PG
24



PG
20

LIGHT-UP HAT

Sew LEDs into a woolly hat using conductive thread

PG
22

TROPICAL TERRARIUM

Create a circular ecosystem in a jar and watch it grow

PG
26

CHEESE PRESS

Build your own wooden press to make tasty cheese

PG
30

TANDOOR OVEN

Use clay pots to build an oven and cook great food on it

PG
16

NEAR-FIELD COMMUNICATION

Use contactless NFC technology to create spell-binding projects



Connect to your fellow makers with CheerLights

Learn to use Python and collaborate in the biggest IoT project in the world



Bruno Santos

@feiticeir0

Linux and Raspberry Pi lover, systems administrator, programmer, kind of a nerd! Loves to create things that may or not work, but could help the world someday!

YOU'LL NEED

- ◆ **A Raspberry Pi** (any will do - we're going to use a Pi Zero W)
- ◆ **NeoPixel** (a stick or a strip - we're going to use a NeoPixel stick)
- ◆ **3 × jumper cables, female-female**

Right

◆ Cheerlights running on two different projects. It's up to your imagination to come up with ideas for enclosures

We're going to dive into IoT and collaborate in one of the biggest IoT projects on the internet - CheerLights.

An IoT project created by Hans Scharler, CheerLights is a network of devices people have created that set their colour based on an API. You can see the current colour at hsmag.cc/dYalRJ. This can be updated by anyone via Twitter: just tweet to [@cheerlights](https://twitter.com/cheerlights), including a colour in your tweet, and suddenly devices all over the world will change to that shade. It's part art project, part a way of learning about the Internet of Things, and part a way of feeling a little more connected to the global maker community.

You can use almost any hardware with a network connection and the ability to change colour in a CheerLight, but we're going to use a Raspberry Pi and a strip of eight NeoPixels.

NeoPixels are RGB LEDs that include a simple controller and networking so that you can connect a strip of them to a single GPIO pin and drive it. The actual networking protocol is a little complicated, but there are libraries for most common maker controllers including the Arduino and Raspberry Pi. We're going to use Adafruit's NeoPixel library that you can download and install from hsmag.cc/kWkKii.

This library allows quite a lot of control over the lights - you can change the colour of individual lights in the strip in any order you like to create quite complex effects using the `setPixelColor(pixel_number, color)` method. We're using this to set all the NeoPixels to the same colour, but for other projects you could use any combination of colours you like.

With NeoPixels, you need to be a little careful of power draw. Each pixel contains three LEDs, each of which can draw up to 20 mA. While this isn't a lot, it can quickly add up. We're using eight pixels, which can draw up to 480 mA. This can be drawn from

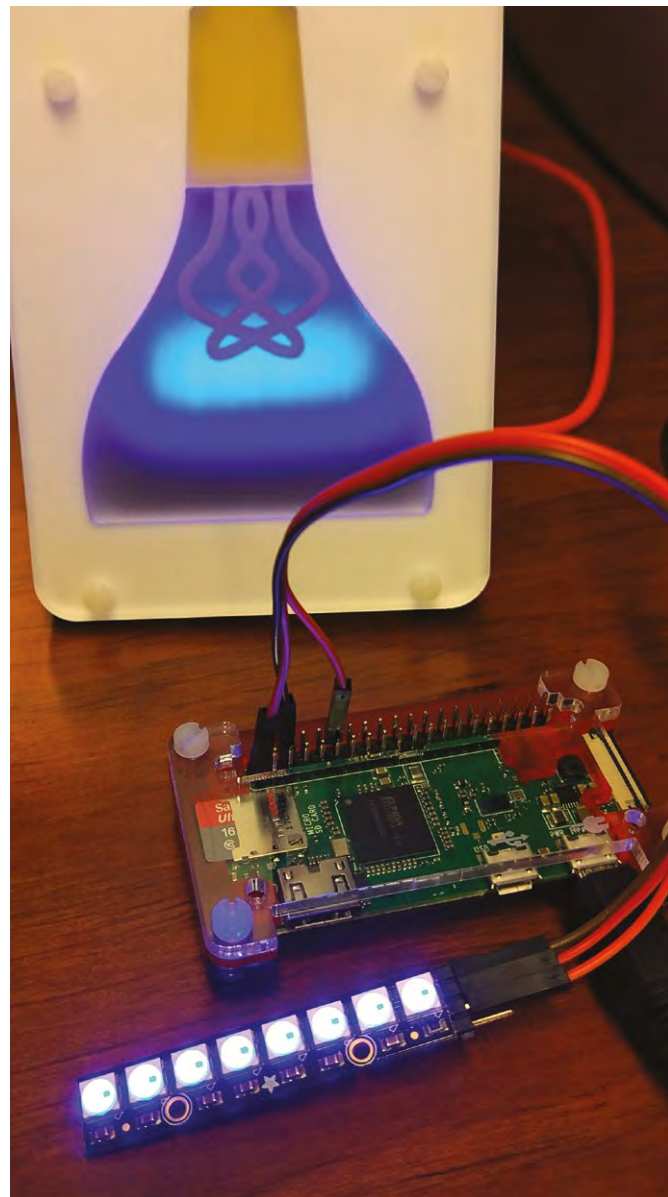

GETTING COLOURFUL

With the CheerLights API, we can get the latest colour in two ways: hexadecimal value or the name of the colour. Each one can come in three possible formats: JSON, XML, or text.

the 3.3V pin on the Raspberry Pi, but if you wanted to add many more you'd need a dedicated power supply, and large displays can require quite careful power management.

The code for our project is:

```
# import libraries
import time
from neopixel import *
import requests

# define color_of_strip
# taken from NeoPixel library
def stripColor (strip, color):
    for i in range(strip.numPixels()):
        strip.setPixelColor(i,color)
        strip.show()
        time.sleep(50/1000.0)

strip = Adafruit_
NeoPixel(8,18,800000,10,False,255,0,ws.WS2811_
STRIP_GRB)
strip.begin()
stripColor(strip,Color(0,0,0))

# store old color
oldcolor = ''

try:
    while True:
        # get cheerlights color using requests
```

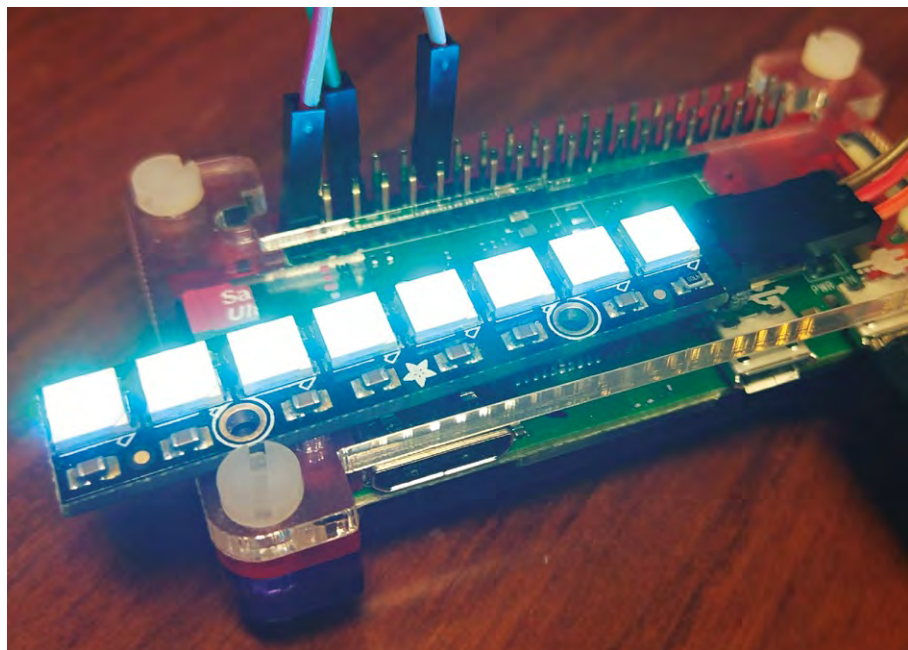

```
lastcolor = requests.get('http://api.
thingspeak.com/channels/1417/field/2/last.txt')
```

```
# store request text value
hex = lastcolor.text
# remove the # using lstrip
hexcolor = hex.lstrip('#')
r,g,b = bytearray.fromhex(hexcolor)
```

```
if oldcolor != hexcolor:
    stripColor (strip, Color(r,g,b))
    oldcolor = hexcolor
```

```
time.sleep(10)
except KeyboardInterrupt:
    print ('Exit')
    stripColor(strip,Color(0,0,0))
```

That's all there is to it. Go out and create your own CheerLight and join this colourful worldwide community. □

Above ▣
Raspberry Pi
Zero W with Adafruit
NeoPixel stick

QUICK TIP

To set a colour, just tweet @cheerlights, or include the word 'cheerlights' somewhere in the tweet with the name of one of the possible eleven colours.

POKING THROUGH PROXIES

If you're behind a proxy server, requests can also use a proxy server. Just set a variable named proxies (you can name it whatever you like) and define your proxy server.

```
proxies = {
    'http' : 'http://<your_proxy_server>:<port>',
    'https' : 'https://<your_https_proxy_server_ip>:<port>'
}
```

Replace the requests.get instruction with this one (replace the url):
r = requests.get(<api_url_in_the_code>,proxies=proxies)

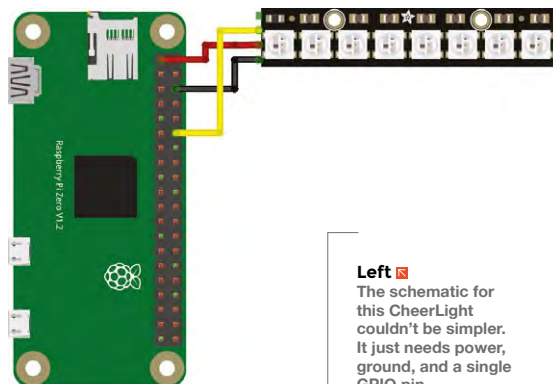

Left ▣
The schematic for this CheerLight couldn't be simpler. It just needs power, ground, and a single GPIO pin

Make a neon-style sign

Make your signs light up with glowing wire



Andy Clark

[@workshopshed](#)

After an aerospace apprenticeship and electronics degree at Imperial College, Andy took a job as a software engineer. For the last ten years he's been making and repairing in a shed at the bottom of the garden. You can see more of his exploits at [workshopshed.com](#)

This project uses electroluminescent (EL) wire and a simple control circuit to light up the sign whenever there is motion in the room.

The sign mimics the style of neon tubes without the cost, weight, and fragility. A motion sensor and timer ensure that the sign is only on when there are people in the room. The control circuit uses a Trinket M0, which means that it can be programmed using CircuitPython, a cut-down version of Python that is designed for microcontrollers.

BENDY IS TRENDY

The key to designing the letters is that you must work within the limitations of the EL wire. The first thing is that you need to create the letters of each word with

Above ♦ Each colour is created with a single length of EL wire with some parts blacked out

a continuous line of wire. The second is that there is a minimum bend radius for the wire. If you bend it too tightly then it might crack and stop working. So that we don't need to keep cutting and joining the wire, black heat-shrink is used to block out the light between letters.

Draw out your letters on paper or CAD to determine the best routing, and to calculate the length of EL wire to purchase. Ensure your letter heights and widths are consistent to get a good result.

Start forming from the connector end. When you come to a break in the light, cut a piece of heat-shrink

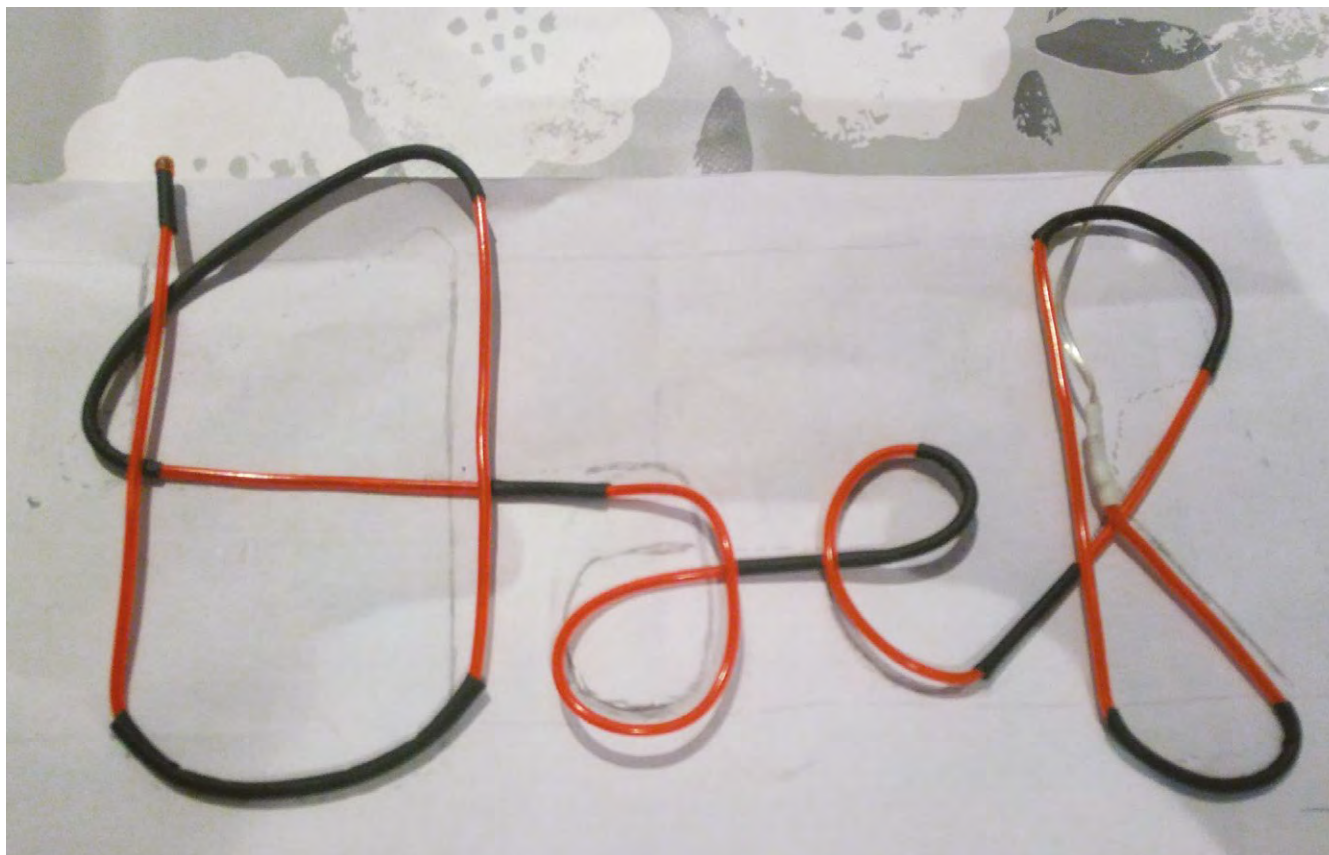

to length and slip it over the EL wire. We used a hot-air gun on the low setting to shrink the sleeving. Try not to use excessive heat, as that could melt the coating of the EL wire.

Once you have all your letters formed, you can then cut the EL wire to length. When cutting the wire, make sure that the thin corona wires do not short-out on the central copper wire. Finish the wire with heat-shrink, or a specialist EL wire cap.

DANGER - HIGH VOLTAGE

The EL inverters produce high voltage of approximately 120V alternating current. Although it is technically possible to switch that, it's simpler and safer to switch the lower 12V input to the inverter. The current from the EL inverters is low, so it is safe to use EL wire around people. However, it is good practice to ensure any exposed cables are covered with heat-shrink. The type and rating of the EL inverter should be matched to the type and length of EL wire. Ask your supplier for advice if in doubt.

ELECTRONIC SWITCHING

The circuit uses two N-Channel MOSFETs to turn on the EL inverters. We used the FQP30N06L, as it can handle the 12V and 1A current provided by our supply.

When cutting the EL wire, make sure that the thin corona wires do not short-out on the central copper wire. Finish the wire with heat-shrink or a specialist EL wire cap

Above  Forming letters

A low-value 120Ω resistor in series, with the gate connection, stops too much current being drawn from the Trinket's I/O pins. A higher-value 10kΩ resistor, from the input to ground, switches off the MOSFET if the control circuit is removed, such as when the Trinket is turned off or disconnected.

When the MOSFET is turned off, the rectifier diode provides a path for any stored energy in the inverter to safely discharge to the supply rail.

HEAT AND MOTION

The passive infrared (PIR) module senses heat and motion. An item that is the same temperature as the background would not trigger, nor would a static but warm item. The module has a simple digital output when it detects motion. There are three wires for this →

QUICK TIP

Note that it is not possible to dim the EL wire using this switching technique. You should aim to keep the rate of switching to a few hertz, or less.

Make a neon-style sign

TUTORIAL

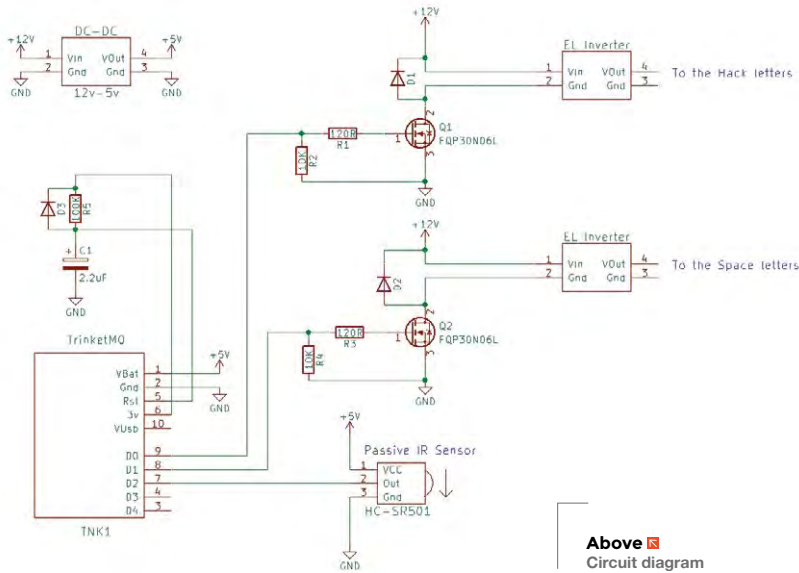

Above Circuit diagram

YOU'LL NEED

- ◆ Power adapter
- ◆ 2 × EL inverter
- ◆ 2 × EL wire
- ◆ Heat-shrink
- ◆ DC-DC converter 12 V - 5 V
- ◆ 2 × N-Channel MOSFET
- ◆ 2 × 120 Ω resistor
- ◆ 2 × 10 kΩ resistor
- ◆ 1 × 100 kΩ resistor
- ◆ 1 × 22 μF capacitor
- ◆ 3 × rectifier diode
- ◆ HC-SR501 passive IR sensor
- ◆ Adafruit Trinket MO
- ◆ 6 mm MDF sheet
- ◆ Paint
- ◆ Edging strip
- ◆ Mounting brackets

module: two for the power, and one for the output which is fed to the Trinket.

The Trinket should boot cleanly into the code on power-up. Ours proved a little temperamental, so a power-on reset circuit was added consisting of a 22 μF capacitor charged slowly via a 100 kΩ resistor. A diode is included to discharge the capacitor when the power is removed.

TIME TO GET THINGS UNDER CONTROL

It is possible to use the PIR module to directly trigger the two MOSFETs. However, so we have a bit more control over how the lights go on, an Adafruit Trinket M0 has been included in the design. This tiny board can be programmed using Python to respond to the sensor and turn on our driver circuits.

The first part of the code brings in the three libraries needed by the rest of the code. The 'board' library defines all of the constants for the Trinket, such as the numbering of the pins. The 'digitalio' library has the definitions for the objects that are used to interact with the digital input and output on

IS YOUR TAB ISOLATED?

Often the big metal tab on a device like a MOSFET is connected to one of the pins. This is definitely the case with the FQP30N06L, so we need to ensure they did not get screwed to the same heat sink. Check your device and circuit to ensure that screwing them to the case or to a shared heat sink will not cause a short circuit. A heat sink mounting kit will provide an insulating shim and sleeve for the bolt to keep the tab isolated from the heat sink.

WHAT IS EL WIRE?

EL wire is really quite simple in construction. A solid copper core acts as a conductor onto which a zinc sulphide phosphor is coated. A thin wire is wrapped around this, often called the corona wire. When a large alternating current is put through the two wires, the phosphor glows. Finally, an outer coating of clear plastic protects the wire from the elements and damage. Different colours are achieved either by doping the zinc sulphide with other chemicals, or by coating the wire with a fluorescent phosphor which glows in response to the light from the EL wire.

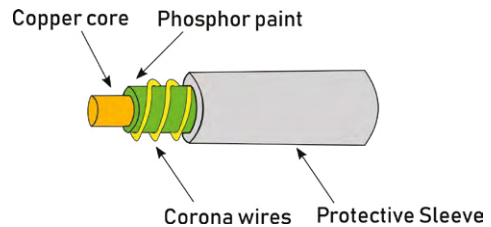

those pins, and the 'time' library gives us the ability to wait and check how long it takes for the code to run.

```
import board
import digitalio
import time
```

The next section configures each of our I/O pins, 0 and 1 as outputs to the driver circuits, and 2 as an input which is wired to our sensor.

```
ELHack = digitalio.DigitalInOut(board.D0)
ELHack.direction = digitalio.Direction.OUTPUT
```

```
ELSpace = digitalio.DigitalInOut(board.D1)
ELSpace.direction = digitalio.Direction.OUTPUT
```

```
sensor = digitalio.DigitalInOut(board.D2)
sensor.direction = digitalio.Direction.INPUT
```

The last section of the code is the main loop that runs constantly. This checks the input from the PIR sensor and turns on the outputs if motion is sensed. A while loop waits until for a period of time before checking for motion again. This ensures that the lights don't remain on for too long, but are not constantly flashing on and off.

```

while True:
    if sensor.value == True:
        #monotonic increments in seconds on the
Trinket
        tstart = time.monotonic()

        ELHack.value = True
        ELSpace.value = True
        #On for 10 mins or until next motion
triggers
        while time.monotonic() - tstart < (10*60):
            time.sleep(1)

        #Turn off if no motion or keep on if still
movement
        ELHack.value = sensor.value
        # Set Space to same as Hack
        ELSpace.value = ELHack.value

```

BACK IN BLACK

The EL wire needs a support to hold it in place. So we are using 6mm MDF, painted black to emphasise the letters.

To create the rounded corners, we used a roll of tape to draw on a pencil line. The corners were then sawn off at 45 degrees. We used a surform to smooth the remaining wood, and finally it was sanded with a coarse sandpaper. Any holes or dents were smoothed over with filler, which was again sanded flat.

To form a case for the electronics, two pieces of MDF were laminated and a hole cut out using a drill and coping saw. We glued a third piece on top to form the lid. Holes were cut out for the wires and the corners rounded in the same way as for the main board.

MDF will absorb paint readily, so a primer is essential to stop the paint being patchy. After the

OTHER IDEAS

- Use more drivers and control each letter
- Use bubble writing for bigger and brighter letters
- Use LED strips instead of the EL wire for even bigger and brighter lights
- Alternate words by placing two wires on top of each other
- Use a Bluetooth module, instead of the PIR, so that the lights come on when a phone is detected



Silver edging designed for arcade cabinets was added around the outside to protect the edges and provide a smart finish



coat of primer, sand the paint back using a medium sandpaper to provide a key for the next layer. A second coat of primer/undercoat will help provide a smooth surface for the top coat. A thin layer of gloss paint was sprayed on and sanded with a 320 grit wet and dry paper. This was repeated until the surface began to look smooth, at which point the paper was swapped with 600 grit. Finally, as the surface began to look really glossy, a 1500 grit paper was used with very light sanding between coats.

To support the wires, split pins were used. The wire was fed through the loops and we put tape over the back to avoid scratching the wall.

Silver edging designed for arcade cabinets was added around the outside to protect the edges and provide a smart finish.

Finally, a couple of hooks were added so that it could be mounted on a wall. □

QUICK TIP

Keep the wet and dry paper very wet, and keep washing off the paint so that it does not scratch the surface.

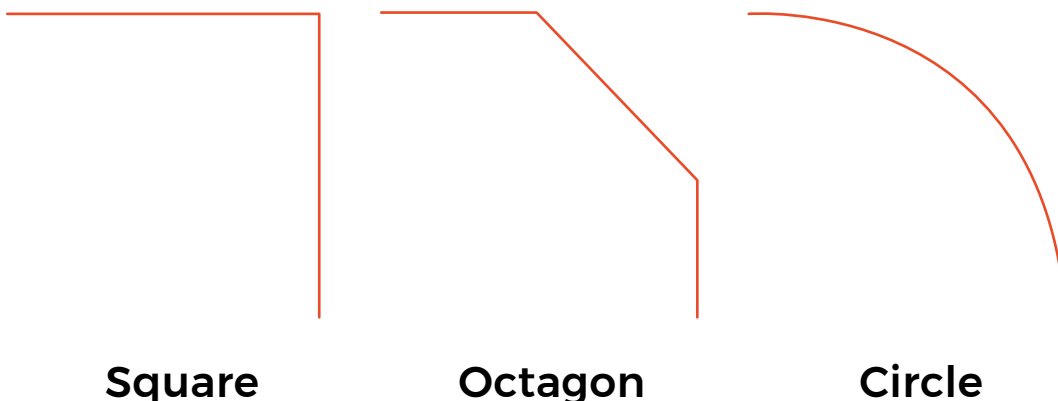

Left ◊
Three steps to round corners

SunGlassBOT

By Ashraf Minhaj

hsmag.cc/PYfkUk

I am a first-year Computer Science student. I love to make robots and program them. I want to build my career in AI and robotics, and am also interested to work anywhere with anyone in robotics.

I believe everything can be turned into a robot or automated machine. That's why, when the idea came up, I took an Arduino, a 10kΩ resistor, LDR and a servo motor, and made this – an automatic, robotically controlled pair of sunglasses that protect your eyes if it gets too bright. I believe I can make anything if I have an idea. □

Right □
We predict commercial success for Ashraf's design, at least on a par with that of Google Glass

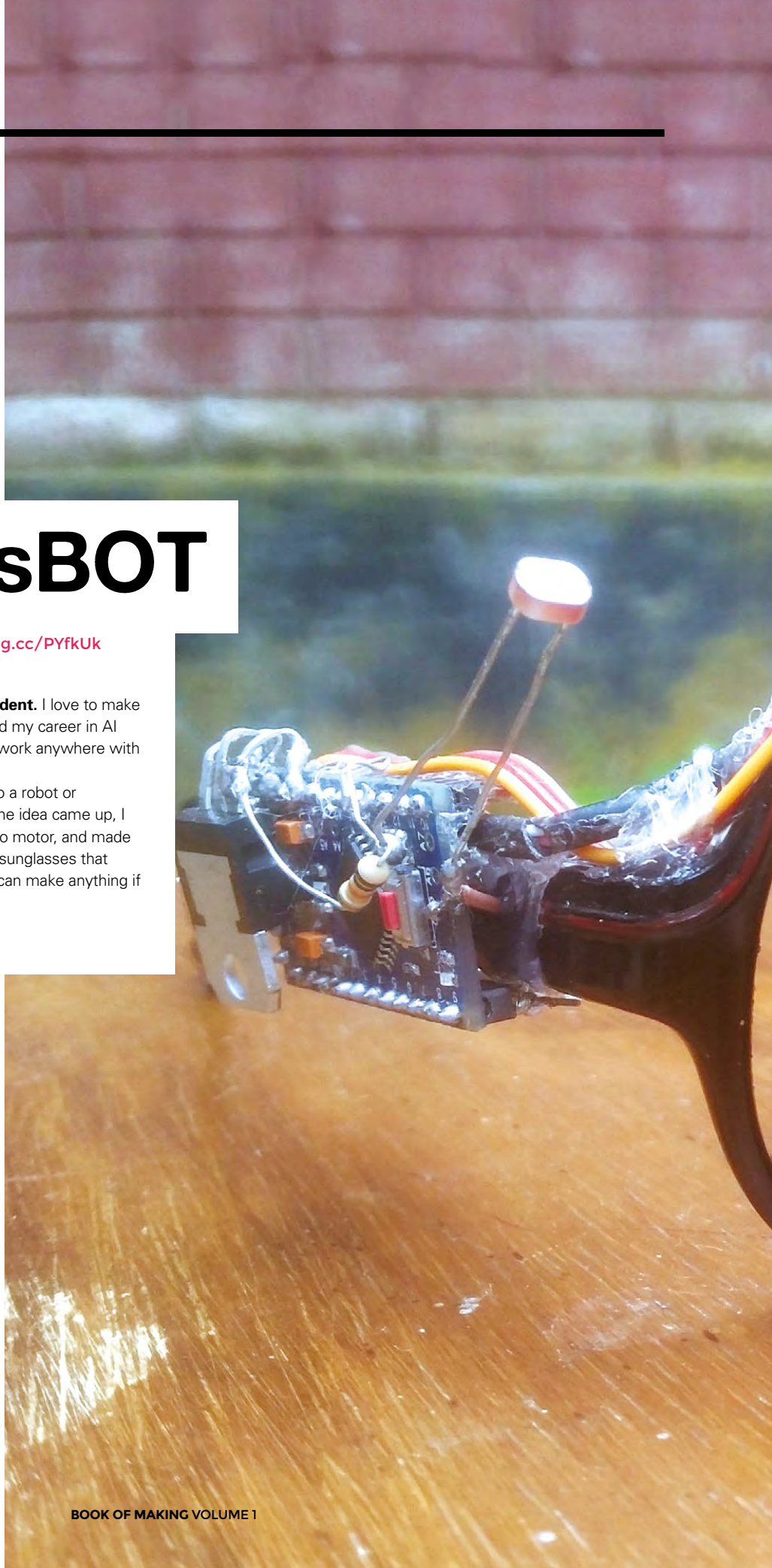



Getting the most out of near-field communication

Some ideas on how to use NFC in your projects to great effect

NFC technology has become cheaper, more accessible, and still has the wow factor when tasks are magically triggered or lights appear to be powered out of nowhere. So why aren't we using it more in our hacks? This tutorial looks at a few ways it can be incorporated into your projects and even used as information prompts for your displays at maker events.

Let's start with what NFC is – it's a form of communication or energy transfer that needs the item to be in an electromagnetic field. The electromagnetic spectrum is something that covers everything from radio waves to x-rays, visible light, and microwaves. NFC is in the 13.56MHz range, which puts it in the radio frequencies, but you don't need a licence to transmit on it!

There are generally two loops: one to provide the power, and the other to use that power to induce a current and send data, or use it directly. If you stick an LED connected to a coil into an NFC field, it will take that energy from the field and light up the LED. I made an example of this by soldering an LED to a coil of wire and then every time I hold it in a field at the right frequency, the LED lights up.

Below ⚡
These spell-casting fingernails are ideal for terrorising small children (image by Sandy MacDonald)



Tanya Fish

tanurai

Tanya has a day job as a crew member at Pimoroni. In her spare time she makes stuff because she can't help herself, enthuses loudly about all things STEAM, and also herds chihuahuas.



NFC is a great medium for small amounts of data, such as a simple message, a weblink, or a task trigger. This was used in great effect in Matt Brailsford's tape deck, where he put an NFC tag in old cassettes to trigger a task (hsmag.cc/JSpoXa). In this case, it was triggering Spotify playlists. The code for such a thing is pretty straightforward: you need the NFC reader to scan for a tag, either constantly or on a button press, and then do something with the data it reads.

This principle works for most tasks – you just have to choose what item you put your NFC tag into, and what to do with the data once you've read it! There is

// NFC is a great medium for small amounts of data, such as a simple message, a weblink, or a task trigger //

a lovely tutorial by Tony Di Cola on the Adafruit website about making paper Minecraft blocks and using them to build blocks in the game. There was a recent art exhibition in Sheffield where the artist, Caroline Claisse, used NFC data tags in items for the audience to interact with her exhibition, triggering animations and lighting by bringing an object up to the artwork.

The exact code will depend on the hardware you're using. If you buy from a maker store, they should give you details of how to use the appropriate libraries for your parts. Roughly, your program should follow this pseudo-code:

```
Look for a NFC card or sticker.
Read the data from the sticker.
Select the block of data that is useful to you.
```

DIY NFC COIL

To make your own, take a piece of wire and then thread two pieces of heat-shrink tubing onto it. Coil the wire up so it makes several loops, keeping the LED connected. Solder each leg of a 5mm LED to each end of the wire. Pull the heat-shrink tubing up to cover the solder joints, and shrink it. Hold the coils in an NFC field and the LED should flash. See **Figure 1** overleaf.

Do something with it.
Write new data onto a block, or all of the blocks.

With just those few examples, you'll realise that NFC can bring a level of interactivity to your projects for a large number of people, and at a relatively low cost. If you have a light display, you could have a number of physical objects of different colours, and as you bring them towards a reader, the colour changes to that of the object. The tags are generally rewritable and you can change what they store pretty easily.

SHARE INFORMATION EASILY

Another use for the NFC tags isn't just in the project – why not use them to store a link to your build site for the project, so when you inevitably run out of cards at an event, people can bring up your site immediately on their phone? If you do this, be a little bit careful which NFC tags you buy, as not all are supported by modern phones. There's a compatibility chart at hsmag.cc/OCcXOd.

WHAT TO STORE?

Most Mifare Classic NFC tags (the most common kind) will store 1kB of data. As with data cards →

YOU'LL NEED

- ◆ **PN532 breakout with a Raspberry Pi 3**
- ◆ **Pimoroni NFC data tags** and the coloured LED nail stickers
- ◆ **NFC stickers** from ZipNFC (UK based): zipnfc.com
- ◆ **Midas 'Tiny' NTAG213** for my initial experiments on thumbnails
- ◆ **NFC reader/writer** Check your phone's compatibility at hsmag.cc/HbfDRT

For the coil

- ◆ **Single LED**
- ◆ **Approx 40 cm of wire**
- ◆ **Two bits of heat-shrink**
- ◆ **Solder**
- ◆ **Soldering iron**

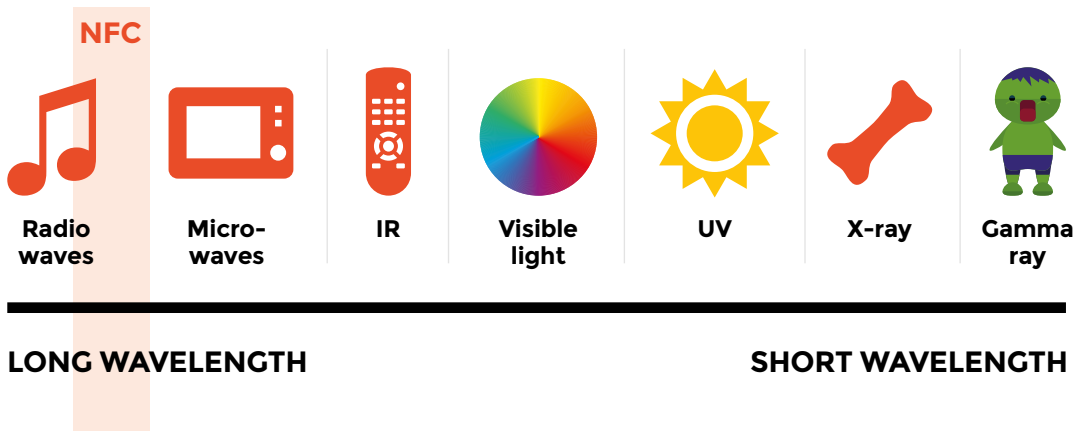

Left ◆ We use many parts of the electromagnetic (EM) spectrum to transfer data and energy in our everyday activities. NFC is part of the radio waves section

Getting the most out of near-field communication

TUTORIAL

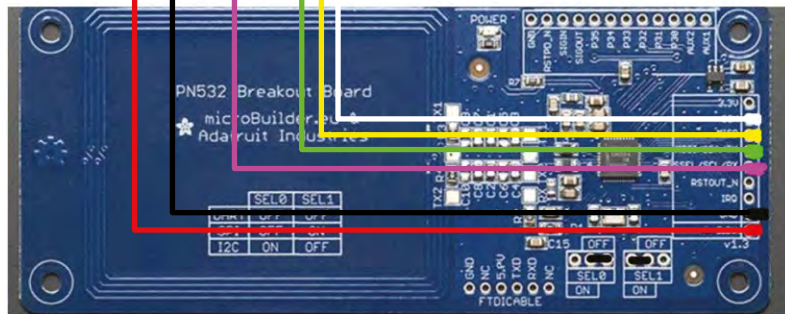
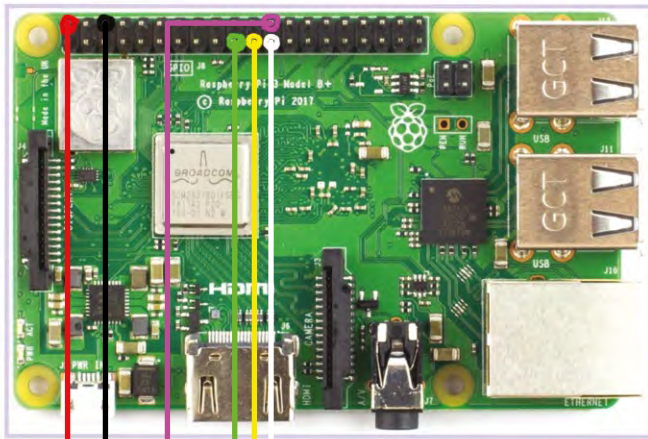

Above ♦ NFC nails lighting up when a contactless bank card is being read

could write 'hackspace.raspberrypi.org' and that could be used to access further information. If you were writing code to use with a reader, you could simply number the tags, and then have the code look up the tag number in a list to find out what to do.

BEDDING IN

Some NFC tags come with a sticky backing, but you can just as easily tape them into a project. The great thing about NFC tags for data storage is that because they're not physically connected to anything for power, they can be hidden in really small spaces and permanently encased in resin, and still work. The only place you can't really put them is behind metal, as this blocks the waves and they won't work. There is a limit to the depth you can embed them, as the name suggests, because near-field communication means you have to be within 5–10cm in air. This rapidly

Above ♦ There's a wide range of NFC hardware for Raspberry Pi, Arduino, and other prototyping platforms

Right ▣ Matt Brailsford placed an NFC tag inside a cassette written with a simple code. The NFC reader inside took this code and sent the music player to a specific Spotify playlist

and internal storage, some of this is taken up by formatting and metadata, so it's not the full amount stated. To put it into context, there's about enough left for one poor joke (What do you call a floating monkey? A hot air baboon!). Rather handily, we've developed ways of allowing people to access further information from a short sentence – for example, I

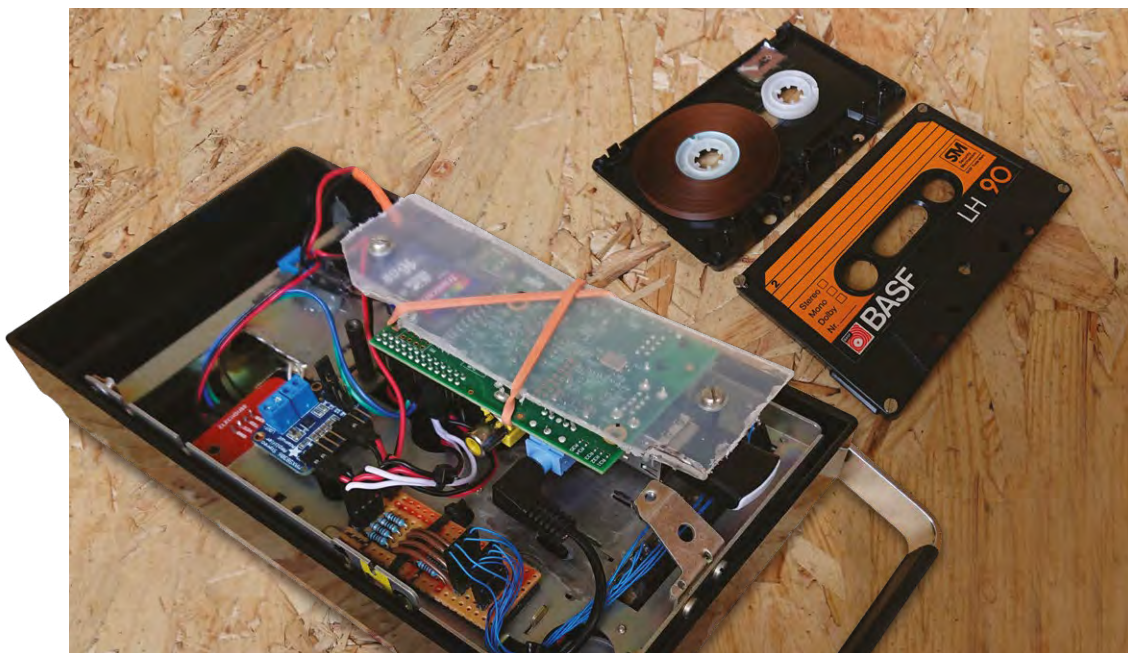

FURTHER IDEAS

Experiment with different coils of wire to see what makes the LED brightest. Is it the size of the coil or the number of turns that makes a difference?

turns into a shorter distance when you increase the density of the material. Thin plastic is fine, paper or card works well, and Perspex about 3 mm deep will still work. This author made a mistake when first embedding them in resin to make jewellery, and put one below a rather chunky 'gem' (OK, plastic). I couldn't then get the tag close enough to the reader to use it without taking the ring off!

CAN YOU PROTECT THE DATA?

Yes... and no. You may have seen RFID blocking wallets, which are basically a mesh or metallic pocket that your bank card goes in, preventing the tag from being read. NFC was developed to be a freely readable data storage method, and so tags



Figure 1  This is the simplest of NFC examples – just wire and an LED

// **NFC was developed to be a freely readable data storage method, and so tags are generally only write-protected**

are generally only write-protected. If you pull a tag out of some packaging (this author got one off her eyeliner; makeup uses them a *lot*), you should be able to read it (a boring inventory number in this case) but not write something new to it. However, some tags have a unique identifier (UID) built in to the tag itself (in those memory blocks you can't write to) so even if you cloned the data onto a new tag, it would have a different identifier. That said, if you got hold of the

original tag you could theoretically clone the UID onto a tag without an existing UID, but you'd have to clone one tag at a time, which puts people off.

More advanced (and therefore more expensive) tags like the Mifare DESFire series are used in things like transport cards that you can top up and use the balance to travel. They can encrypt the data so they wait for a key from the reader, send their own key back, and the reader is then 'allowed' to access certain parts of the data.

In short, the security of them relies on you being aware of readers around you and keeping far enough away not to be read, which is usually around 10cm, but we are aware of research into a reader that can be used from 80cm away.

And finally, when we were asking around for projects people had used NFC on, we were impressed by one: at the Ministry of Defence they use tiny little NFC tags to keep track of their inventory... of tanks. 

Below  This jewellery was made to store secret messages in – bring the pendant close to an NFC reader such as a phone and the hidden message will appear on the screen

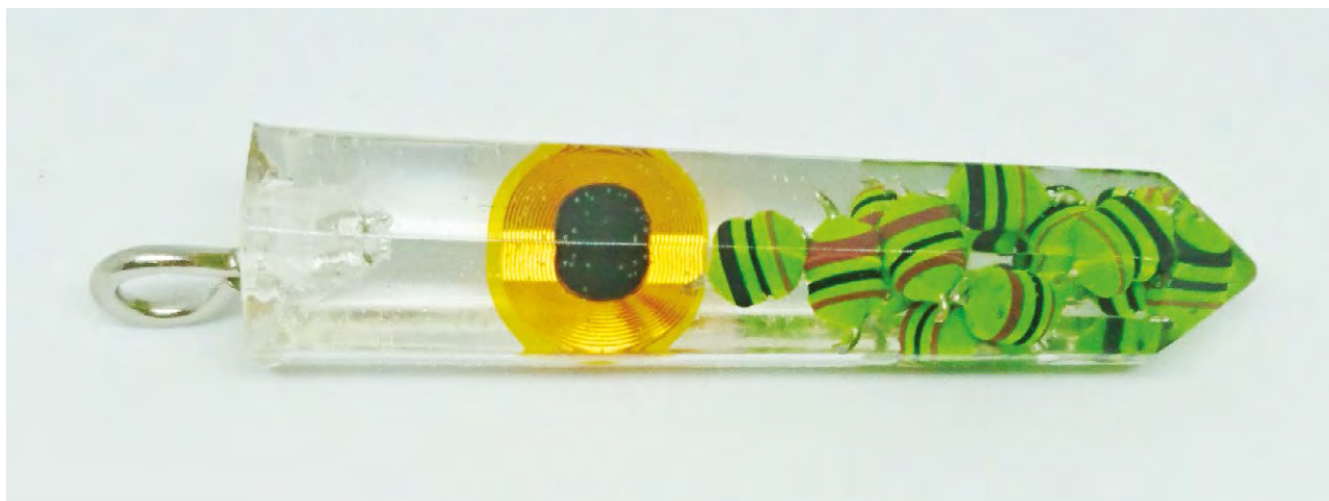

Sew lighting into a hat

Keep yourself warm and visible on dark nights with a simple circuit



Sophy Wong

@sophywong

Sophy Wong is a designer, maker, and avid creator. Her projects range from period costumes to Arduino-driven wearable tech. She can be found on her YouTube channel and at sophywong.com, chronicling her adventures in making.



This is a simple and easy sewn circuit project, and it's great for getting started with wearables. We'll sew three LEDs onto a knit hat for more visibility at night. Once you've gotten the basics down with this project, you can use this circuit to sew LEDs into other garments too. Let's get started!

CIRCUIT OVERVIEW

We'll be sewing the LEDs in parallel, so that each LED gets the same amount of voltage from the battery. All the LEDs will be in the same orientation in our circuit. Look for the + and - on each LED and follow the circuit diagram (shown right) as you build. Leave the battery out of your battery holder until you've finished building the circuit.

PREPARE THE HAT

The LEDs will be attached to the outside of the hat, and the battery holder will be hidden inside the hat's folded cuff. You'll either need to use a hat with a cuff or fold back the edge of a longer hat. If your cuff

doesn't want to stay folded, tack it up at the sides with a few stitches of regular sewing thread. The cuff should be at least 4 cm wide to accommodate the battery holder.

ADD THE LEDs

If your sewable LEDs came in a strip, gently snap them apart with small pliers. Find the front of the hat. Place the three LEDs on the front of the hat fold with the negative (-) side up and the positive (+) side down. Space them about 1.5 cm apart. Tack each LED in place with a small amount of hot glue.

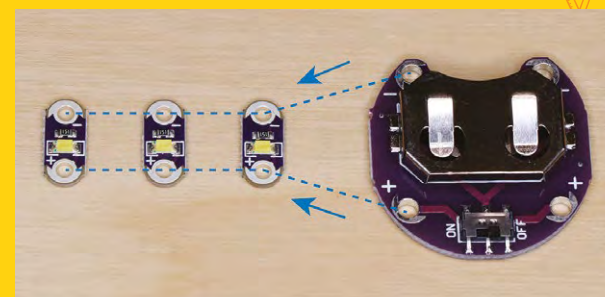

Above  Be seen in the dark with a light-up hat

Right  Connect the LEDs to the battery holder



Above ♦ The battery holder lives on the inside of the folded-up part of the hat, its unsightliness hidden

ADD THE BATTERY HOLDER

Since the battery holder is a rigid, flat piece, we'll place it on the side of the hat so it will be against the flat part of your head. Fold the edge down at one side of your hat. Place the battery holder so that its opening points toward the edge of the hat and the negative sew tab is on top. Use a dab of hot glue to tack it in place for now.

SEW THE CIRCUIT

Now that we have our components tacked in place, we can sew the circuit to connect them. Thread your needle with about 50cm of conductive thread and tie a knot at the end. This may feel like a long piece of thread, but we want to sew each leg of the circuit in one continuous run.

Start at the battery holder: begin your run by stitching four or five times around the positive sew tab of the battery holder. Pull the thread snug against the sew tab for a good connection.

Use a simple running stitch to sew to the positive sew tab of the first LED. Loop around the positive sew tab four or five times, pulling snug each time.

Below ♦ The battery holder should go along the side of the hat, where it will fit along the side of your head.



Continue sewing this leg of your circuit, and connect to the positive sew tabs of the other two LEDs in the same manner.

When you've connected the last positive sew tab, tie off your thread with a tight knot. Trim the thread close to the knot to prevent short circuits.

Rethread your needle with another 50cm length of conductive thread. Go back to the battery holder and repeat this process to sew the negative leg of your circuit. Keep this second thread run at least 1cm away from the first.

LIGHT IT UP

Now, slide a coin cell battery into the battery holder. The LilyPad sewable battery holder has a handy on/off switch, so turn your project on and try it out. The battery holder should sit comfortably on the side of your head, and no conductive thread or component should be touching your skin.

If your LEDs don't light up properly, check

to make sure they're all aligned correctly with each other, and that the battery holder is in the same orientation: negative sew tab on top. Also make sure your conductive thread tails are trimmed to prevent shorts, especially at the battery holder.

Your author doubled the LED magic by repeating this process on the back of her hat with red LEDs. How will you customize this project and make it your own? Show us your build at [@HackSpaceMag!](#) □

YOU'LL NEED

- ♦ Knit hat (find one with a folded cuff)
- ♦ 3 × sewable LEDs
- ♦ 1 × sewable coin cell battery holder
- ♦ 3 V coin cell battery
- ♦ Conductive thread
- ♦ Regular sewing thread
- ♦ Wire cutters
- ♦ Needle, thimble, scissors
- ♦ Hot glue gun and glue sticks

// Once you've gotten the basics down with this project, you can use this circuit to sew LEDs into other garments too //

Below ♦ White LEDs at the front, red at the back



Make your own living terrarium

Create a circular ecosystem in a jar and watch it grow



Jen Botezat

@neurogenerator

I am a DIY enthusiast with a passion for making. You can often find me in the garden, whether my own or a community one, as I especially love making them look beautiful. I volunteer at the Alpine & Rock Garden at Kew Botanical Gardens.

Terrariums create a closed environment for plants, free from dust and pollution, with a constant level of humidity that allows tropical plants to thrive. Perhaps our fascination with terrariums is part of the larger movement to bring plants into our homes, especially when we have little space. In this tutorial, we will be making a tropical terrarium, inspired by the first one ever invented. You rarely need to water it, and you can watch it grow over many years as a brilliant living addition to your home.

PEBBLE AWAY

Start with a glass container which you can seal. Here, we are using a demijohn (traditionally used as the vessel of choice by merchants storing wine and spirits). Carboys, boiling flasks, jam jars, vases, fish bowls, and even the odd light bulb make excellent options for a tropical terrarium.

Fill the container with a layer of pebbles for drainage. Make sure to wash the pebbles beforehand. A layer about 10cm-high works well for the demijohn. You want to leave space in the container for the compost and plants to grow. To make adding pebbles easier, make a funnel out of an old plastic pot (make a cut along one side of the pot, wrap it inwards, and insert it into the top of the demijohn).

THROW IN CHARCOAL!

This is an important step that's often forgotten when making a tropical terrarium. Sprinkle a teaspoon

of activated charcoal powder over the top of the pebbles. Try not to get the powder on the glass walls. The charcoal helps purify the water as it circulates through the terrarium in a closed loop, and prevents the build up of unwanted moss and algae.

Fill the terrarium with a layer of regular compost or potting mix, about 20cm for the demijohn. A funnel is really useful for this step. Don't worry if you leave soil residue on the sides of the container – we will clean this at the end.

WHAT TO GROW

For this tropical terrarium, you will want plants that are native to the tropics and thrive under canopy. Ferns (such as Button ferns and Boston ferns), ficus pumila, calathea, ivy, red or green fittonias, and the friendship plant are all excellent choices. Likewise, cushion moss will look chunky and lush in your terrarium. Select plants with different colours, textures, and heights to give your terrarium that extra wow factor. If the plants come too big, divide them by gently pulling apart and teasing out the roots.

Get your creative juices flowing as it's time to design. How you arrange the plants inside is what makes your terrarium unique. For this step, you will need to make some tools specifically for a terrarium. You can make most of these yourself. Make a cork tool and a sponge tool by attaching a cork and a small sponge onto sticks.

Now use the long stick to make a small hole in the compost. Poke the hole until you feel the pebbles below. This is where your first plant will go. Drop the plant down into the terrarium and carefully wriggle into place with the long tweezers or stick. Use the cork tool to tamp down the compost around the plant. Don't plant more than one plant in a single hole, as this can get fiddly. Rather, plant each piece one by one, making holes as you go along. Drop in the cushion moss and tamp down with the cork tool to position it.

THE FIRST TERRARIUM

In 1829, entomologist Dr Nathaniel Ward put a Sphinx moth chrysalis and some leaf mould into a sealed glass container to watch it develop. Instead, a miniature fern grew inside. Ward concluded that the container maintained a constant humid environment, perfect for tropical plants, and so the 'Wardian Case' was born. Wardian cases allowed tropical plants to survive long sea voyages to the UK and spurred a fern craze in Victorian times. The fern motif began to appear everywhere, even on Custard Cream biscuits!



YOU'LL NEED

- ◆ Sealable glass jar
- ◆ Pebbles
- ◆ Activated charcoal powder
- ◆ Regular potting mix
- ◆ Small tropical plants and moss
- ◆ Spray bottle with water

TOOLS

- ◆ Make your own terrarium tools with a cork, sponge, and several long sticks
- ◆ Long tweezers and radiator brush (if you have them)
- ◆ 1 × plastic plant pot (to create a funnel)

DESERT TERRARIUMS

You may have seen succulent and cactus terrariums. Such terrariums require an open container and dry, arid conditions that mimic their native desert habitat. Effectively, they require the exact opposite to the humid environment of a tropical terrarium. If you see a cactus or succulent planted together with a fern, it won't last long!

Once you have finished planting, use the sponge tool or radiator brush to wipe off any soil residue from the walls of your terrarium. A dry sponge or paper towel works well.

Terrariums don't do well when water is poured directly over them. Instead, use a spray bottle and spray inside five to seven times, going around in a circle. This should be enough to start off your terrarium. And voilà. Your terrarium is ready!

KEEP AN EYE ON IT

For the next two weeks, your terrarium will go through a hardening period. During this time,

alternately seal it with a cork for a few days and leave it with no cork for a few days. There is no strict rule for this, but doing so will help your plants adapt to their new environment and regulate the humidity levels inside the terrarium. Monitor for any signs of dying plants during this time and pluck them out or replace. If any are to die, you will see it in these two weeks. Water one more time after the hardening period and feel free to leave the terrarium alone, sealed, for a long while.

Now, you can sit back and watch the plants grow and evolve. A terrarium is never static, and you'll be able to watch it grow and change over time – the perfect green feature for your home.

Where you put your terrarium matters. Direct sunlight will cook the plants and too little sunlight will kill them too. Place the terrarium in a bright place, but out of direct sunlight. A windowsill is perfect for this. Also, keep the terrarium away from radiators and avoid overwatering. If the plants get too large and leggy, trim them back. Avoid letting them touch the glass. To clean the terrarium inside and out, use a dry cloth, and never use harsh chemicals. □

Above □ Think about the height of your plants for a 3D look

Below ◆ The tools you need can easily be made or improvised



Wood bike

By Jason Cram

hsmag.cc/wfMDej

I'm a software engineer at Boeing and a weekend maker.

The thinking behind using plywood for a bicycle frame is to replicate some of the shock absorption seen in mountain bikes. Also, using wood as a composite can create a very tough and strong building material. With the right design, the bike frame should flex and offer a smooth ride. It took around six months to build, with a lot of shaping, sanding, and varnishing. I used it for three to four years as a mountain bike, and it worked pretty well. However, I broke the head tube and the seat post, and repaired it. Also, there is a bit too much flex in the crank when you pedal hard. Some parts need to be as rigid as possible, while in other areas I want flexibility, and with more engineering it'll work great. I have other ideas and designs for wood bikes that I'll build at some point, but for now I converted this bike into a cruiser-style bicycle, and I enjoy riding it around my neighbourhood. □

Right □
Plywood is light, flexible, and perfect for (most) of a bike frame





Build a cheese press

Because squeezed curds are more delicious than they sound



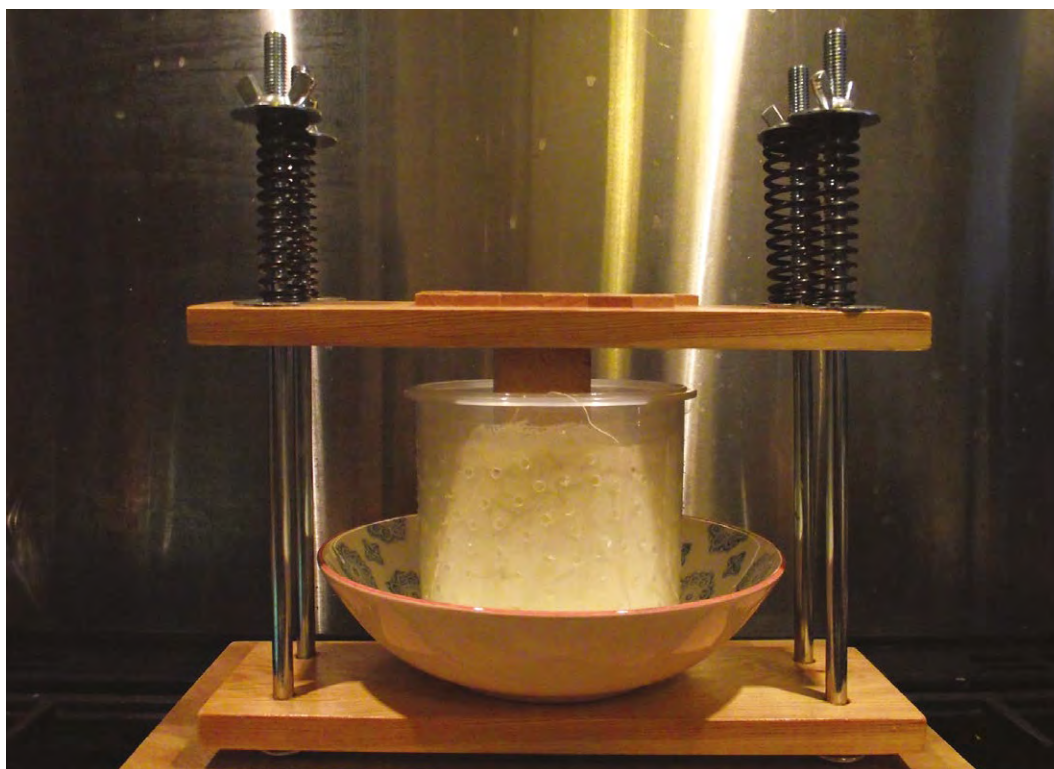

Ben Everard

🐦 @ben_everard

Ben Everard is the editor of HackSpace magazine and a maker whose projects always seem to lead to food, including an irrigation system that waters his vegetables and a 1947 radio (converted to a Bluetooth speaker) that keeps the music flowing in his kitchen.

Cheese is basically curdled milk that's had much of the whey removed. A cheese press is a device for removing the whey by squeezing the curds (typically wrapped in a cheesecloth) until they reach the desired

consistency. The resulting cheese can either be eaten fresh or aged to make a mould-ripened cheese such as Brie or Stilton.

There are loads of designs for cheese presses, varying from the simple (like the one in this tutorial) to the complex. In general, the more complex presses can apply more pressure, which allows you to both make a bigger range of cheeses, and larger cheeses.

Our design is kept as simple as possible because the simpler it is, the less there is to go wrong. There are two planks – one at the top, one at the bottom – that are squeezed together using four bolts (tightened with wingnuts). Compression springs between the wingnuts and the plank even out the pressure.

The compression springs need to be able to take enough weight without collapsing completely. Look for ones that can take more than 50 newtons of force. Fortunately, it's trivial to switch them around, so you can experiment to see what works best with the sorts of cheese you're making.

With all the parts assembled, building the press is simple: you just need to drill holes for the bolts in the corners of the planks. These need to be far enough in from the edge that the planks don't split when

Above

You may wish to place your mould in a bowl to catch the whey as it drains out of the curds

pressure is applied. We put them 25mm in from both the end and the side, but it doesn't have to be exact. We drilled holes 2mm larger than the bolts we used to give us a little wiggle room if they're not exactly vertical or in quite the same place on the upper and lower planks. Once it's in use, the force being applied will keep everything stable, so this slight wobbliness isn't a problem.

The only other thing to do is cut the chocks. These are just 100mm × 100mm × 100mm cubes of wood that can be inserted between the upper plank and →

FURTHER HACKING

Do you have an insatiable desire for more cheeses and more hacking? If you want to set yourself up to create an even wider variety of cheeses, you'll need a temperature and humidity controlled environment. If you want to mould-ripen cheese, you're going to need to create the right environment for your chosen mould to grow. This depends on the particular cheese, and typically is the cool, damp air found in many caves – which is exactly where cheeses have been traditionally aged. Unless you happen to have access to a hole in the ground, the best DIY approach is usually to modify a fridge.

YOU'LL NEED

- ◆ 4 × 30 cm M10 bolts
- ◆ 4 × wingnuts
- ◆ 8 × washers
- ◆ 4 × compression spring
- ◆ 2 × wooden plank
18 mm × 169 mm × 400 mm (approx)
- ◆ Wood
100 mm × 100 mm × 200 mm (for chocks)
- ◆ 12 mm drill bit
- ◆ Handsaw
- ◆ Cheese mould
- ◆ FOR THE CHEESE
- ◆ 4.5 litres whole milk
- ◆ 130 ml white vinegar or lemon juice

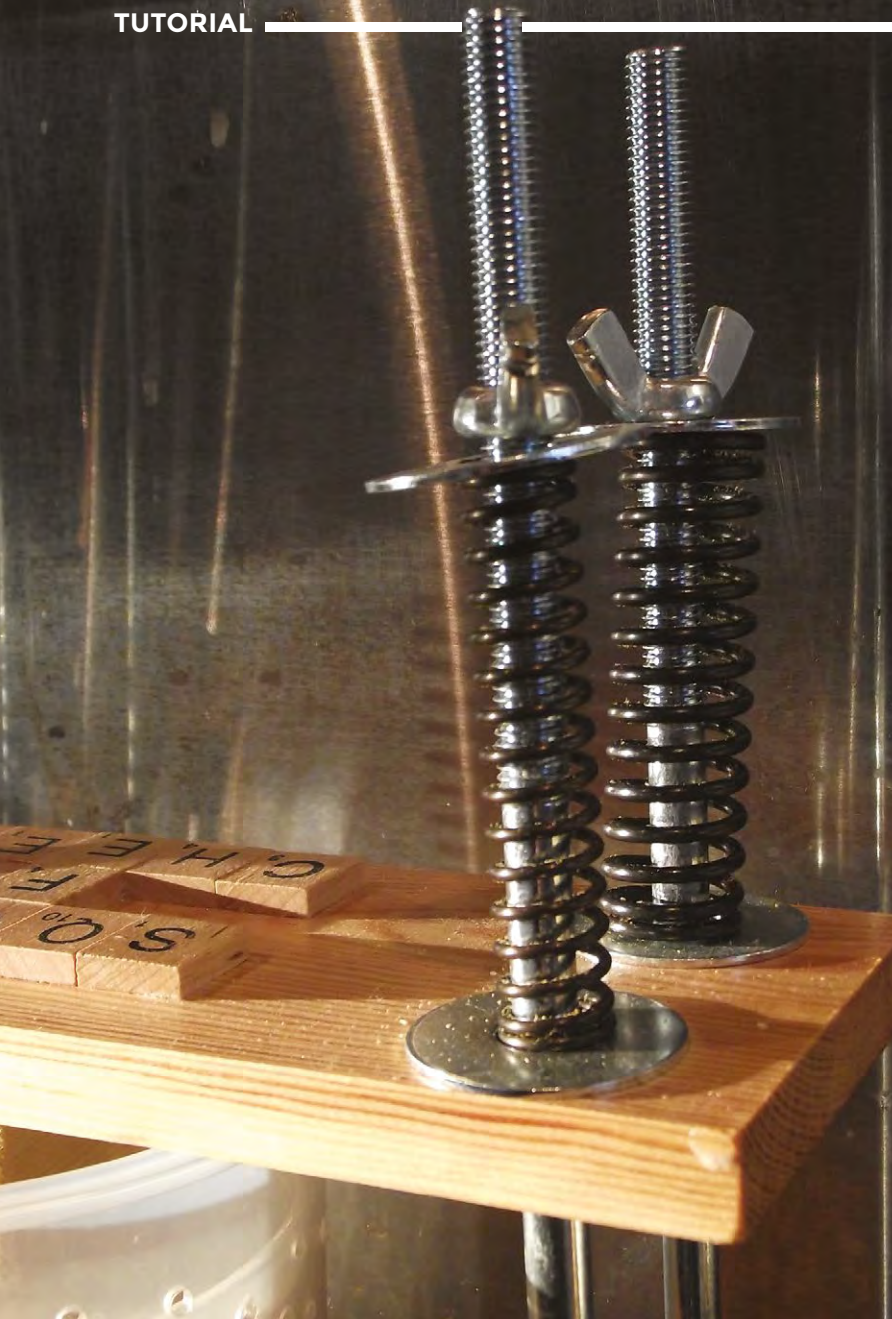

Left  The washers, wingnuts, and springs are used to apply pressure to the curds

the plunger (in the mould) to apply the pressure in the correct place. We opted for chocks, rather than a solid bar, so they can be inserted and removed depending on how full the mould is.

In addition to the press, you'll need a mould. By this, we don't mean the blue fluffy stuff that makes Stilton delicious (though you can get some of that as well), but something to shape your cheese. You can buy these or make them. They should be shaped to allow the pressure from the press to push a plunger into the mould, pressing the cheese curds together, and with space for the whey to escape as the pressure increases. Ours is made from a cylindrical Tupperware pot with holes drilled in the side and the top trimmed down to make it fit inside. If making your own, make sure that it's made from food-grade material, as some plastics can leach dangerous chemicals into the cheese – this is a particular risk here as the cheese is acidic.

Ideally, you'll want to know how much pressure your cheese press is exerting. You may remember from school that:

$$\text{pressure} = \text{force} / \text{area}$$

You need to know the force your press can exert and divide this by the area on the top of your cheese mould. Technically, force should be measured in newtons but, in practice, it's often measured using weight – 1 kg of force is the force of gravity on a 1 kg weight.

If you have scales that can measure at the appropriate degree of accuracy, then you can use these to calibrate your press (by measuring the length of the springs at different amounts of force you can then reapply this amount of force without using the scales). You can get by without doing this, at least with basic cheeses, but you'll have more success if you can consistently apply the correct pressure to your cheeses.

MAKING CHEESE

That's the press made. Let's get on with making some cheese. Paneer is a great first cheese. It's fairly straightforward to make, but still demonstrates much of what you need to make cheese. As it's a fresh cheese without any ageing, you can enjoy the fruits of your labour quickly.

The first part of making paneer (as with most cheeses) is curdling the milk. With paneer, this is

OTHER PRESSES

You don't actually need a cheese press to make cheese. Anything that can apply pressure to a cheesecloth-wrapped ball of curds will do. One common option is to place a pan full of water on top of the cheese. This works to an extent, but it can be difficult to get the balance correct to supply even pressure over a long period of time.

If you find yourself wanting to make larger cheeses or applying more pressure than our little press can handle, the next

step up is a 'Dutch' press, which uses levers and weights to apply pressure to the cheese. While these are more complex than ours, they're still within the reach of someone with modest woodworking skills. If you're really looking to increase the quantity you're making, you might want to go hydraulic. A car-jack and a suitable frame should be able to apply vast amounts of pressure, but make sure the frame's strong enough as any structural failure could be catastrophic.

done by adding something acidic, but with other cheese, this is often done by adding rennet.

Heat your milk in a large metallic pan until it's 90°C. Milk has a tendency to stick to the bottom of the pan and burn, so heat it slowly and stir it often. It's not a complete disaster if a little of it does stick to the bottom of the pan, but the less that does, the better the cheese will be. Once you've hit 90°C, turn the heat off, add the vinegar, give the mixture a good stir, then put a lid on the pan. You should see the milk start to split and curdle almost instantly, but it's best to give it at least ten minutes to properly curdle. If it doesn't curdle, you could try adding a little more vinegar and waiting longer.

While this is happening, it's a good idea to scald the rest of the equipment. This will help keep everything as sterile as possible. Pour boiling water over the cheesecloth, mould, plunger, and anything else that will come into contact with the curds. As paneer is eaten fresh and not aged, it's not quite as essential to keep things sterile, but it's good cheese-making practice to keep things clean.

Now that the milk has split, you need to extract the curds into your mould. First, place a cheesecloth in the mould, then – using a slotted spoon – transfer the curds into the mould, leaving as much of the whey behind as possible. It's important to drain the curds in the spoon for a few seconds before putting them in the mould, as this means there's less whey for the press to remove.

Once you've got all the curds in the mould, fold the cheesecloth over the top, place the plunger on there, and put your cheese in the press. Start by adding a little pressure, then slowly build it up by giving the wingnuts a twist every half hour or so. You should

MOULDY CHEESE

Cheese gets really comes to life when bacteria and fungi get to work to develop complex flavours. Traditionally these are introduced by storing cheese in the same place as other cheeses and letting the spores transfer across. This is unreliable and risky for the amateur, as it's hard to guarantee what moulds will transfer and it is possible to end up with a dangerous strain of bacteria growing in your cheese. Fortunately, you can buy cultures that you can add to your cheeses. There are three common types of cheese culture:

- * **Mesophilic:** The most common cheese culture, this can be used in both fresh and aged cheeses.
- * **Thermophilic:** Used in cheeses heated to a hotter temperature.

* **Penicillium:** The fungus that gives blue cheeses their distinctive colour and texture.

Recipes will often call for more than one of these and they may need to be added at different points in the cheese-making process. There's a great range of recipes to try at cheesemaking.com.



build up to around 150–200 pascals pressure (which, in our 20 cm diameter mould, translates to a little over 10 kg weight). You should find that the plunger moves down the mould as the pressure is increased. You might find out that you have to add an extra chock to help it push the plunger deeper into the mould.

The cheese will need at least a few hours of pressure, and overnight is best. Once that's done, take the pressure off the cheese, take the cheese out of the mould, and you have your own paneer, which is almost ready to eat. Paneer is typically eaten cooked – either fried or grilled. It's delicious on its own, but even better when added to curries. □

Above ♦ Move beyond paneer and recreate your favourite cheeses with recipes from cheesemaking.com

Below ♦ Curds in the mould waiting before applying pressure. The more whey you drain before placing the curds in the mould, the better your cheese

PICKING MILK

If you struggle to get curds, the problem could be the milk. Our paneer recipe has worked well with all the supermarket milk we've tried it with, but other recipes can be more fickle. Most milk is treated to stop it separating (this is called homogenising), and this can cause problems. If you have access to farm-fresh milk, this can be more successful.

In general, the more fat in the milk, the better. Whole milk is the minimum you should use for cheese making. In the UK, gold-top milk from Jersey cows generally has a higher fat content. You can also artificially increase the fat content by adding cream to the milk before starting with the cheese making.

It's best to experiment with the milk you have available to find what works best for you.





Build a tandoor

Party like it's 1999 (BCE)



Above 🔥
Grilled perfection –
lamb kebabs roasting
in the intense heat of
a clay oven

A

tandoor is a roughly cylindrical clay oven that's traditionally heated by wood or charcoal burning within the oven itself. This design leads to a high internal heat, and this high heat leads to a distinctive flavour in the final dishes.

The intense heat from the coals radiates up and grills the meat, while the high air temperature (held in by the clay sides) bakes it, and the juices dripping off the meat vaporise and steam the meat. This three-in-one cooking method is impossible to replicate in any other way.

The tandoor style of oven is both simple and capable of creating a fantastic flavour. It's the combination of these two things that have led to them being used across southern, central, and western Asia for over 4500 years. The only real change in modern times is that some are now gas-fired, rather than using wood or charcoal. We'll construct a charcoal-powered tandoor using a few flower pots.

The constituent parts of a tandoor are fairly simple. You need a clay cooking/burning vessel. This needs to have an air supply at the bottom to keep the fire burning, and a lid to keep the heat in. It also needs to be insulated to ensure that heat is held in. If you've got the capabilities for working with clay, then you may be able to make one from scratch. However, for those of us without a kiln large enough to bake a tandoor, there is the short cut of assembling your tandoor from premade clay pots. The cheapest and most readily

THE HEAT IS ON

We've talked quite a bit in this article about ways of getting the tandoor hot enough. This is important because it's this heat that gives food the distinctive tandoori flavour. However, it is possible to get too much of a good thing. If you overheat your tandoor, you run the risk of cracking the pots, and you'll struggle to properly cook your food.

The best way of checking is with an infrared thermometer (you'll need one that reads up to about 550°C). Just point it at the wall of the tandoor to see what temperature you've reached. We found that the ideal cooking temperature is around 400°C, though your tandoor should work fine between 350 and 450°C. Like other methods of cooking over wood and charcoal, the exact temperature isn't critical, it's the process of cooking the meat in the steam produced from their juices dripping onto hot coals that produces the delicious flavour of the tandoor. If in doubt, try cooking with it, and if the food is cooked all the way through and you like the flavour, then your tandoor is working properly, regardless of what a thermometer might say.

available clay pots, large enough for a tandoor, are terracotta plant pots.

There are lots of ways of doing this, and there's no special secret that makes one method better than the others, so experiment with the design if you want one that looks different or is a different size to the one we're making. →



Ben Everard

🐦 @ben_everard

Ben has combined his kitchen and workshop. A kitch-shop if you will. It's where he creates food using power tools and electronics. Laser cut bacon anyone?

YOU'LL NEED

- ◆ Terracotta pot
23 cm diameter
- ◆ Terracotta pot
30 cm diameter
- ◆ Terracotta pot
40 cm diameter
- ◆ Charcoal
- ◆ Dremel and cutting disc
or other tool for cutting terracotta



Left ◆ Our three pots lined up. The exact sizes aren't important as long as they fit inside each other



STAYING SAFE

In this article, we're making a cooking container out of terracotta that's not classified as food-safe. Flowerpot cooking is common and recommended by such culinary luminaries as Jamie Oliver, Alton Brown, Martha Stewart, and Mary Berry; however, some people are concerned about the risk of lead.

Lead has traditionally been used in ceramic paints and glazes, and almost all of the concern about lead in ceramics

comes from this. Since we're using unpainted and unglazed pots, this isn't a problem for us.

It is theoretically possible that the source of clay is contaminated with lead, although we've been unable to find any cases where this is confirmed to happen. However, prudence is advised when it comes to food-related hacks, and you can purchase a non-destructive lead testing kit and check your pots before cooking.

The inner chamber of the tandoor is made of two pots: a small one placed the right way up, and a slightly larger one placed upside down on top of it. This creates the egg-shaped fire and cooking chamber.

You'll need a way of getting the food in and out of the chamber, so you need to remove the base of the medium-sized clay pot so that this can lift off and be used as a lid. Terracotta is fairly soft – at least as far as ceramics are concerned – which means it's not too hard to work with. If you go carefully, you can cut it with a wood saw, but it will damage your saw so we wouldn't really recommend this method. A far better option is to use a tool with a blade designed for cutting such materials. We used a Dremel rotary tool with a suitable cutting disc (Dremel recommends 426 fibreglass reinforced discs for ceramic).

Above ♦
With the 'lid' removed, our tandoor is ready for assembly

Terracotta literally translates as 'cooked earth', and that's basically what it is. In its basic form, the surface is orangey-red and porous, and it's this form that you want. It is possible to get glazed terracotta pots with a shiny or colourful finish – these particular ones could cause problems, as the surface coating used may not be stable at high temperatures, or may not be safe for food. Even if it is, the glossy surface will affect the way food cooks, so stick with the basic, raw terracotta varieties.

One slight issue with these pots is that they're slightly porous, which means that they will absorb a little water if it rains. Obviously, this water will turn to steam when it gets hot and this may expand more rapidly than it can escape from the terracotta. Keep your tandoor covered when not in use, and make sure it's dry before firing it up.

MAKE THE INCISION

Mark out the line that you want to cut. We opted to go 2.5 cm down from the top, but any height that you can reach with the cutting disc should work. When cutting ceramic, we find it easiest to first go around the entire pot with a shallow cut, then gradually make this deeper and deeper until it's gone all the way through (rather than cutting all the way through in one place and cutting around the pot). In our experience, this is a bit less error-prone.

Make sure you wear eye protection and a dust mask as it will kick up plenty of small particles (while this isn't toxic dust, it's not good to inhale). It can be a bit noisy as well, so ear defenders are also useful, and

as always, follow the safety advice that comes with the rotary tool.

With this pot cut and inverted on top of the smaller pot, that's the heart of your tandoor made. The only issue with using this as a standalone cooker is that it will lose a lot of heat out of the side, which makes it harder to hold the high cooking temperatures associated with tandoori cooking. We need some insulation.

The easiest way of insulating your tandoor is to place it in a larger container and fill the gap between with something that traps air and is safe at high temperatures. There are a few options here. We've seen people use metal bins, but since the tandoor is going to be in our garden for years to come, we'd like something a little more aesthetically pleasing. We've gone for a larger terracotta pot. As this one won't come into contact with food, you don't have to be quite as careful with the pot. Though, do bear in mind that parts of it (particularly the bottom) will get hot.

KEEPING WARM

In an ideal world, this larger pot should be slightly shorter than your stack of two pots that make the inside of the tandoor. However, creating perfect height pots for tandoors doesn't seem to factor into the design of terracotta pot manufacturers, so it's usually a question of doing the best you can with the available materials. If some of the upside-down pot pokes out above the insulation, then it's not the end of the world, but does mean that you might need a bit more fuel to get fully up to temperature. It will also result in a less even cooking temperature in your tandoor. This is a particular problem for things that stick to the side – namely naan bread. We found that our tandoor cooked fine without the insulation going all the way up.

For the material in the middle, you'll need something that's easy to pour, and inert. We've used perlite – it's available from some garden centres and online. Though if buying, be aware that it's quite light, so →

AIRFLOW

Oxygen is critical to any fire, and especially important to a cooking fire. Too much, and the air dissipates some of the heat, which can limit the temperature the tandoor can reach. Too little and there's not enough to sustain the fire. Our tandoor has a single air intake – the hole in the bottom of the small flower pot which can't be adjusted, but the lid can be removed and this will ease the air escape and increase airflow over the coals. Closing or removing the lid gives you a crude control over the airflow.

If you find that you're not getting up to temperature and your coals are struggling to burn, you might find that you need more air inflow. You can do this by gently drilling additional air holes in the bottom of the tandoor. There are no hard-and-fast rules for this, so you'll need to experiment to find the right amount.

Below  The small pot inside the large pot. Notice how the air holes at the bottom line up



WHAT TO COOK

The most famous tandoori foods are, of course, lamb kebabs. This is because the small size of the meat means that they can be cooked all the way through before the outside is burned. This small size also makes them perfect for our little tandoor. If you've made a larger tandoor, you can also cook larger chunks of meat: on-the-bone chicken is particularly delicious.

Whatever meat you choose to cook in your tandoor, the marinade is particularly important. Not only does this give a fantastic flavour, it also protects the meat from burning. Tandoori marinades usually contain yoghurt, which forms a protective barrier, as well as tenderising the meat and helping the flavours of the marinade penetrate.

A very basic tandoori marinade is made from a mixture of yoghurt, spice mix (tandoori spice mixes are widely available), cooking oil, and lemon juice. From here you can tweak it to your tastes – we're particularly fond of adding some additional cumin. Coat your meat with a liberal amount of marinade and leave in the fridge for at least a few hours, preferably overnight.

Alternating meat and vegetables (such as onion or pepper) on kebabs is both great for flavour and helps the meat cook evenly.

There's also a delicious range of traditional tandoori breads including, most famously, the naan. These are flatbreads that cook stuck to the inside of the tandoor. The basic approach is to make a yeast-leavened bread dough (possibly including nigella seeds), rolling it out until it's thin, proving it, and then pressing it onto the side of the tandoor to cook. It's a bit of an art to get them in and out without singeing your arm, but there really is no other way to get that proper naan flavour. Brush with melted butter and serve with your tandoor-cooked meats.

You can, of course, cook vegetable kebabs. These are at a slightly higher risk of falling off the kebab stick than meat, so make sure you've got something solid on the bottom (such as a firm potato) to stop the whole lot sliding off into the coals.

If you've been reading the other guides in this book, you may have come across the cheese press (page 26). This is ideal for making paneer (a type of fresh cheese) that's a perfect vegetarian option for the tandoor. However, items in the tandoor are cooked in the steam given off by juices dripping on the coals, so if you've invited vegetarian guests over, be sure to cook the paneer first, as any cooked at the same time as meat will stretch the definition of vegetarian.



Right ♦

Perlite is often sold by weight – be careful as it's much lighter than it looks. A couple of kilos should be plenty for a tandoor this size

**Above** ⬆

Don't get the thermometer too close to the tandoor. We melted the front of ours getting this reading

the quantities when sold by weight can be confusing. A kilo or two should be all you need for this. This light weight does make it a bit susceptible to high wind, though, and it can look like you've had a bit of unseasonable snow if you don't cover it up once you've finished with it.

Just assemble all the bits and you've made yourself a tandoor.

BURNING UP

Fill up the base of your tandoor with charcoal and light. You can get two different types of charcoal – lumpwood and briquettes. We found that briquettes worked far better than lumpwood. The biggest difference was that lumpwood included a range of sizes, and the smaller pieces filled all the gaps and stopped the air flowing freely. There aren't any

// The inner chamber of the tandoor is made of two pots: a small one placed the right way up, and a slightly larger one placed upside down on top of it //

hard-and-fast rules for how much charcoal you'll need to get up to temperature, so it's best to err on the side of caution and start small, then build up if you're not yet at the desired heat.

Lighting can be a bit of a challenge as the charcoal is at the bottom of a long chimney-like structure. This means that any flame is going to travel upwards to

the arm holding the lighting implement. We found that it worked to add some BBQ lighter gel to the coals at the bottom, then add it to one end of a bit of coal not in the tandoor. Light the bit outside the tandoor and, when it's well lit, place it in the tandoor using tongs. This lights the rest of them without removing any arm hair. Don't use anything that can flare up as it catches fire, such as petrol or other liquid fuels.

Leave the top off to allow more airflow through the tandoor until the coals are lit and burning nicely, then pop the top on and wait for everything to get fully up to temperature. Obviously, this lid will get very hot while cooking, so don't touch it with bare hands. Use either a metal implement or a pair of high-temperature gloves (such as welding gauntlets).

It's best to give your tandoor a full burn-through before using it for real. This helps to both burn off any contaminants that may have gotten on the pots, and gives you a chance to see how it burns without risking your delicious food. We found that ours took quite a bit of time to get fully up to temperature (about an hour), but could hold this for over an hour, so gave us plenty of time to cook up a feast.

Now you're ready to start cooking – stoke up the coals and get the kebabs on. Do let us know about your tandoor builds. Get in touch [@HackSpacemag](https://twitter.com/HackSpacemag) on Twitter, or email hackspace@raspberrypi.org.

Below ⬇

You should get a good, even burn, but it may take time to light fully



AFTERNOON PROJECTS

HACK | MAKE | BUILD | CREATE

Got an afternoon to spare? Try one of these projects to learn something new or just have fun tinkering

Top Projects – Showcase

Waterwheel pump

PG
54



PG
38

LETTER BOX

Get push notifications to find out when your postie's been



PG
44

SONOFF SWITCHES

Turn devices on and off with these smart WiFi switches

MUSIC BOX

Build a touch-activated music box with no coding required

PG 56

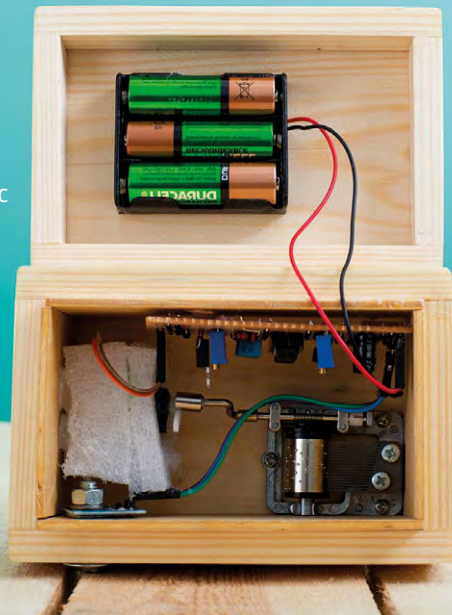

PG 50

ARDUINO SYNTH

Make your own 8-bit synthesizers with Arduino

PG 60

STORAGE BOX

Protect your tools from rodents with this metal box

PG 66

DREMEL TABLE SAW

Upgrade your multi-tool to make perfect straight cuts

PG 70

LASER-CUT TURNTABLE

Create stunning 360° animated GIFs with this geared turntable



Top Projects – Showcase

Robot that shoots you in the face

PG 74

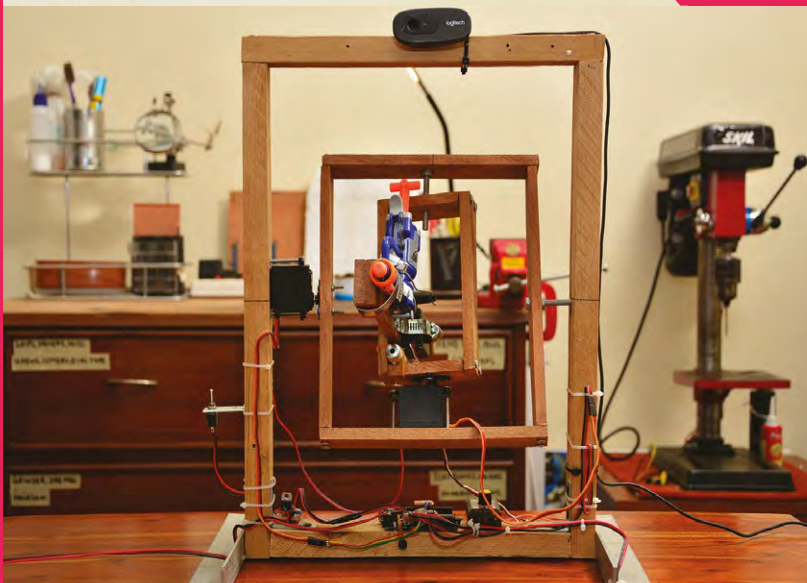

Upgrade your humble letterbox with push notifications

Use a magnetic switch to find out when your postie's been



Paul Freeman-Powell

[@paulfp](#)

Paul is a technology enthusiast, geek, video producer, drummer, cyclist, husband, father to three children, including twins, and host of the award-winning Switched On Network YouTube channel. You can find his website at switchedonnetwork.com

Have you ever been eagerly waiting for an item to arrive in the post, and wished you could tell straight away if it has finally arrived?

Maybe you're out at work when the postman comes, or your letterbox is at the end of a really long driveway? Well, this is the project for you – we'll show you how to rig up a tiny Raspberry Pi Zero, and a sensor switch, to send a push notification to your phone every time the letterbox flap is opened.

Before we get started, I'm going to assume that you already have your Raspberry Pi Zero all set up, with the latest version of Raspbian installed and up to date, and the date and time correctly set. You'll also need a mini HDMI cable and a USB hub with a micro USB connector, in order to plug in a keyboard and mouse for the initial setup.

With that all ready, start by connecting up the magnetic switch to the numbered GPIO pin 18 and a ground pin – see the wiring diagram overleaf for details. If you strip a short length from the ends of your bell wire, this should easily slot into the female DuPont cables, for easy connection to the GPIO pins. The other end is wired into the sensor switch. Wiring-wise, that's it – it's a very simple setup.

Connect the Pi to your home network, either via WiFi or with a network cable, then enable SSH access (Pi menu > Preferences > Raspberry Pi configuration > Interfaces > SSH), so you can access the Pi from another computer on your network

later. Determine the Pi's IP address on your home network by opening a Terminal and typing the following command:

```
hostname -I
```

Now that's all set up, you can start configuring the vital services required to make things work and talk to each other. This project works by adding a new row to a Google spreadsheet each time the magnetic switch is activated (i.e. the letterbox is opened), along with the date and times that it was opened and closed. Another service then monitors this sheet and sends the alert to your phone whenever it sees that a new row has been added.



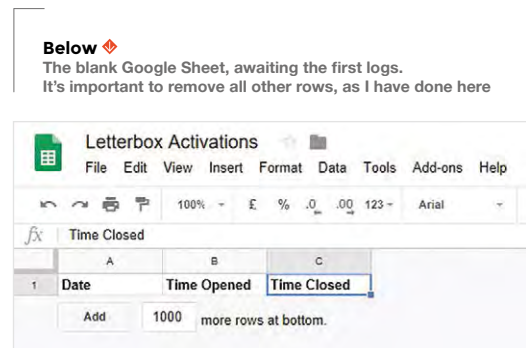









Create a new Google Sheet and call it Letterbox Activations. Set up three columns as headings, then delete all other cells so that your sheet looks like the image below. This is important, as the Python →



Left 

The complete wiring setup. The ends of the bell cable are stripped and fit nice and snugly into two female DuPont cables connected to the Pi Zero's GPIO pins

YOU'LL NEED

-  **Raspberry Pi Zero W** (ideally with a pre-soldered header)
-  **Mini HDMI lead or adapter**
-  **USB hub to plug into the Zero's micro USB port** (for keyboard/mouse)
-  **Magnetic contact switch** (door sensor)
-  **Long length of bell cable**
-  **2 × DuPont cables** (female/female)
-  **Long USB power lead for the Pi**
-  **A smartphone or tablet**
-  **A Google account** (free)
-  **An IFTTT account** (free)
-  **Glue gun, or other method of fixing**
-  **Adhesive Velcro strip** (to mount the Pi Zero)

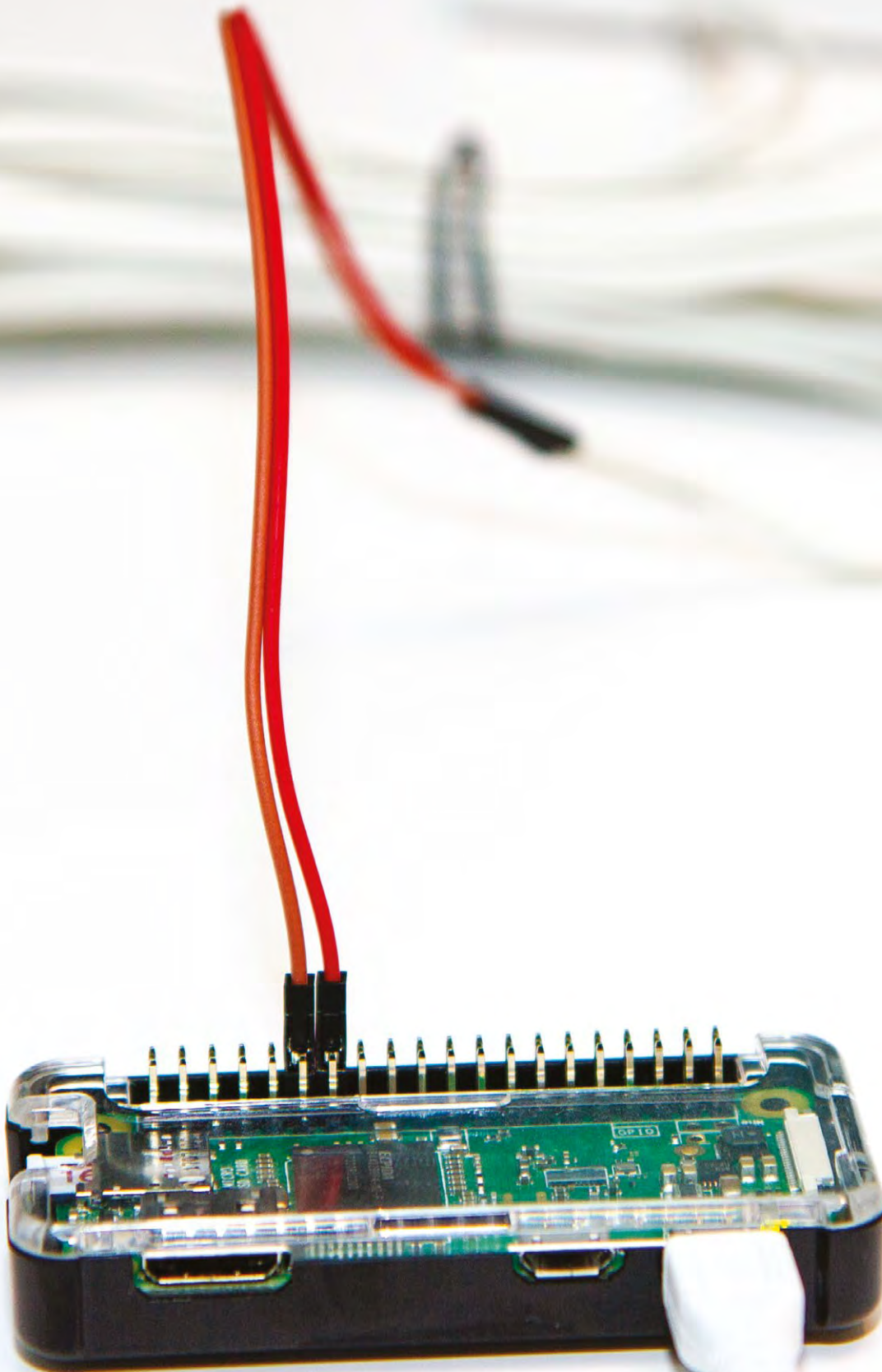

TUTORIAL

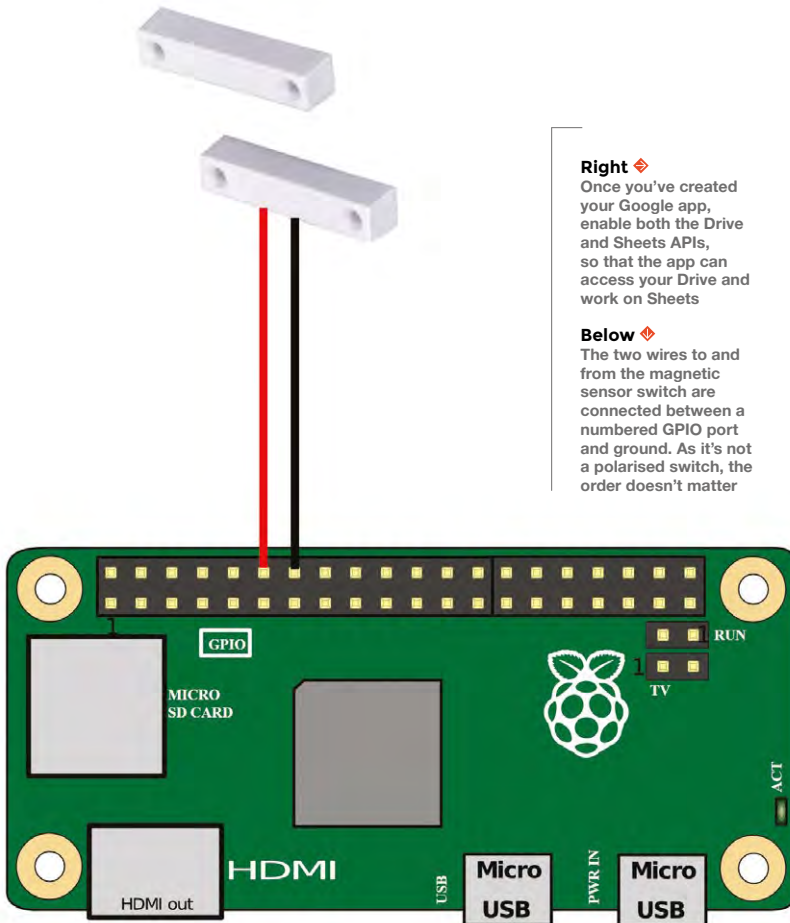

Right ♦
Once you've created your Google app, enable both the Drive and Sheets APIs, so that the app can access your Drive and work on Sheets

Below ♦
The two wires to and from the magnetic sensor switch are connected between a numbered GPIO port and ground. As it's not a polarised switch, the order doesn't matter

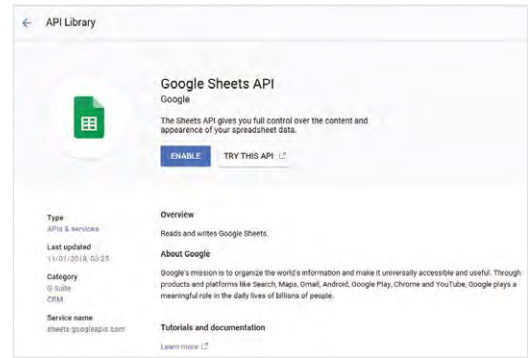

'Choose action' select 'Send a notification from the IFTTT app'.

The action fields allow you to customise the message that's sent to your phone with each push notification. The message needs to say something like this, using the values which have been added to the spreadsheet:

'The post arrived on {{ColumnA}} at {{ColumnB}}!'
Click 'Create action', then review and 'Finish'.

In order to receive the push notification, you must have the IFTTT app installed on your phone, so open up the Google Play Store, install the IFTTT app, and log in with same account that you used to create the applet.

You can test it out by manually adding a new row to the spreadsheet; wait around a minute and a push notification should pop up on your phone. Now that's working, it's time to make that happen automatically each time the letterbox opens.

// The action fields allow you to customise the message that's sent to your phone with each push notification

//

script adds a brand new row to the bottom each time the letterbox is opened.

QUICK TIP

If you have any other 'smart' devices in your house, you could easily expand this project to talk to those too. For example, you might want to turn on a smart WiFi light bulb for a couple of minutes a few seconds after the post arrives, to make your house look occupied while you're away.

IF THIS, THEN THAT...

To monitor the Google spreadsheet, and send push notifications to your phone, you will use a free service called If This Then That (IFTTT), at ifttt.com.

Sign up for IFTTT if you don't already have an account. Click on New Applet, then click on the big '+this' to add your 'this...' scenario/trigger, which will be that new row getting added to your spreadsheet. Under services, search for Google Sheets and then select 'New row added to spreadsheet' as the trigger. After authorising access to your Google Drive, paste the full URL of your Google Sheet into the box and click Create Trigger. Now that the trigger is set up, you need to add the action. Click on the '+that' and search for the 'Notifications' action service. Under

FOLLOWING THE SCRIPT

The project uses a Python script which detects the letterbox activations and then uses the Google Sheets API to add a row to the spreadsheet. It needs to be authorised to edit the spreadsheet in your Google account, and to do this you first need to create an app on the Google Cloud Platform at hsmag.cc/QypiUm.

Create a new app and give it a name. Next, you need to enable both the Sheets and Drive APIs for your app: from your app's dashboard, click APIs & Services in the left menu bar, and then select Library. Search first for Drive and then enable it – and then do the same thing for Sheets.

IF THIS THEN THAT

If This, Then That (IFTTT) is a free online platform which allows you to join together your various apps and IoT devices. It can talk to lots of online services and smart devices as both trigger and action, and, as the name suggests, it allows you to specify that 'if this happens, then do that'. Have a play and let your imagination run wild at ifttt.com.

**Above**

The applet you create on IFTTT monitors your Google Sheet for new rows being added, and sends a push notification to your phone when it spots that the post has arrived

Next, click back to go to the APIs & Services dashboard and click the Credentials item on the left-hand menu. Here, click the 'Create credentials' button and select 'Service account key'. On the next screen, 'New service account' will be selected; give it a name such as 'postman-log'. Under 'role' select Project, then Owner, leave the key type as JSON, and finally click Create.

You can test it out by manually adding a new row to the spreadsheet; wait around a minute and a push notification should pop up on your phone

This will create and download a credentials file to your computer. Save this to the Pi user's home directory as **service_file.json**, or if you are doing this from another computer, use something like WinSCP to copy this JSON file to the Pi.

Now that your app on the Google Cloud Platform has the ability to work with Sheets in your Drive, it

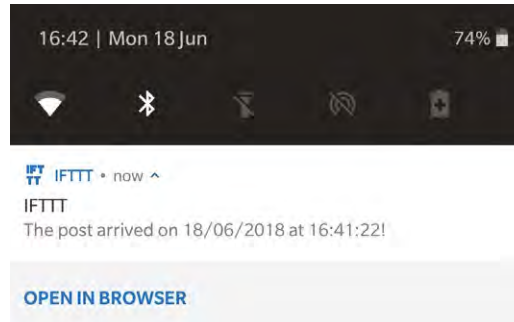
**Left**

The notification, as it appears on your phone each time the letterbox flap is opened

needs to be granted specific permission to access the Letterbox Activations spreadsheet. Open up the JSON credentials file and look for the line which starts 'client_email'; after that will be a long email address. Copy the email address (without the quotes), return to your Google Sheet and click the SHARE button in the top-right of the browser window. Paste the email address from before into the People field, ensure 'Can edit' is selected and press the Send button. Press Yes to any 'Are you sure?' style warnings – this enables the app we've just created to make changes to the spreadsheet, which is what we want.

Next, use PuTTY to connect to your Pi from another computer on your network, using the IP address we determined earlier, which will usually be something similar to **192.168.0.xxx**.

The project uses the pygsheets library to make working with Google Sheets easier. Install pygsheets with the following command: →

Below

Install the IFTTT app on your smartphone, and log in with the same account in order to receive the push notifications

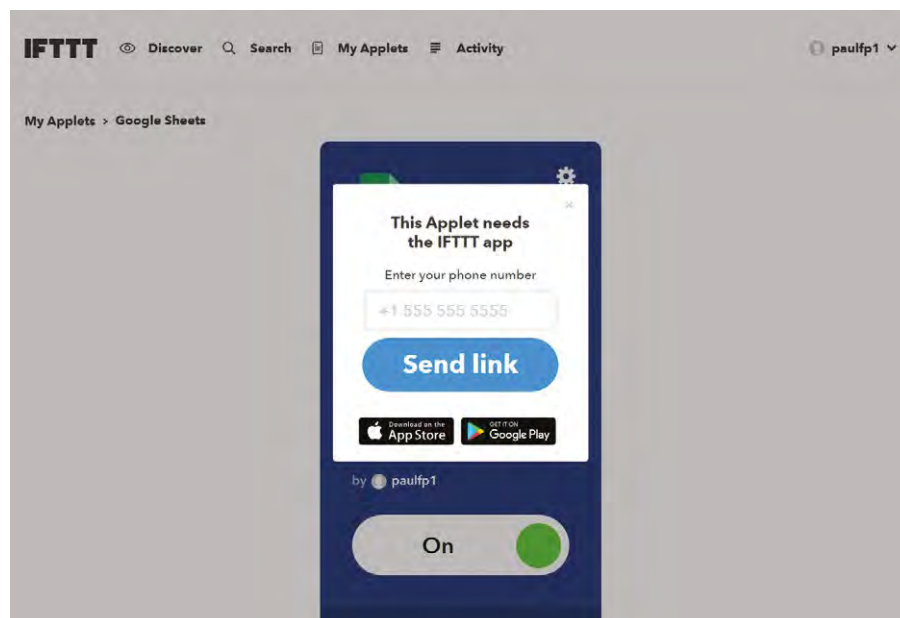

Upgrade your humble letterbox with push notifications

TUTORIAL

QUICK TIP

It's a good idea to set a static IP on your network (outside your router's DHCP range), so that weeks later and after several reboots, your Pi will still be accessible via the same IP address.

Right

For a less obtrusive look, pop open the case to reveal the magnet, and stick this to your letterbox

Below

Position the magnet and switch with Blu Tack and, once you've confirmed the distances are correct, you can use some hot glue to hold in place

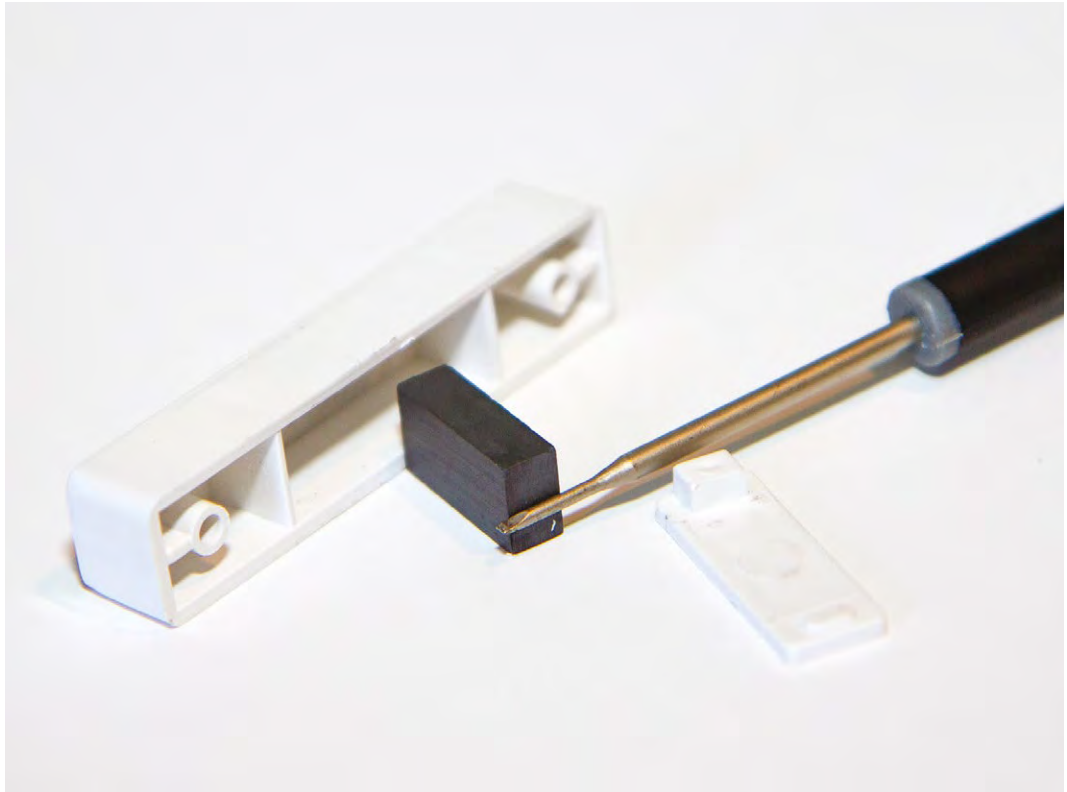

```
pip install https://github.com/nithinmurali/pygsheets/archive/master.zip
```

To authenticate with the Google Sheets API, the script uses OAuth, so be sure the `oauth2client` is installed on your system by typing:

```
pip install --upgrade oauth2client
```

Once that's done, you're ready to install the main Python script from GitHub:

```
git clone https://github.com/paulfp/Letterbox-Push-Notification.git
```

This will download the script into a new directory called **Letterbox-Push-Notification** within the Pi user's home directory. Make sure the magnetic sensor is in the closed state and you can now run the Python script like this:

```
cd ~/Letterbox-Push-Notification  
python letterbox.py
```

When you first run the script, there will be a brief pause whilst it connects to Google. Once done, you'll see 'Letterbox is closed' printed to the Terminal. Test it out by moving the magnet away from the switch and back again. When you do this,

you will see 'Letterbox has been opened!' and 'Letterbox is closed' printed to the Terminal window, along with the date and time of each action. If you watch your Google Sheet whilst you do it, you'll also see a new row being added and then populated.

Due to the IFTTT applet you made, within about a minute a push notification from the IFTTT app should pop up on your phone. You can even press the notification to open up the spreadsheet and see the full details, including when the letterbox was closed again.

// You can even press the notification to open up the spreadsheet and see the full details, including when the letterbox was closed again **//**

Finally, set the script to auto-run each time the Pi loads, so that it'll work once installed on your letterbox without needing to hook up a display and keyboard. To do this, edit the Pi's **autostart** configuration file:

```
sudo nano ~/.config/lxsession/LXDE-pi/autostart
```

Add this line at the end of the file:

```
@python /home/pi/Letterbox-Push-Notification/letterbox.py
```

Now that everything's working, it's time to install the system on your letterbox. Depending on the exact design of your letterbox, you may need to adjust how you fit yours, and experiment a bit with the placement of the magnet to ensure that the system correctly

REMOTE ACCESS

WinSCP and PuTTY are two very useful utilities for connecting to your Raspberry Pi (or any Linux machine). WinSCP for Windows gives you an easy tool for transferring files between your Windows machine and the Pi, and PuTTY allows you to run commands on it remotely, as if you were connected to the machine directly with a screen and keyboard. You can install the latest version of each from ninite.com – look under Developer Tools.



Above ♦ The Raspberry Pi Zero can be mounted out of the way, using an adhesive Velcro pad

Below ♦ This project is proof that you don't need complicated wiring to make a useful device

registers as open/closed when the letterbox is in either of these states. A nice long length of bell wire, as well as a long USB power lead, should ensure that you can locate the Pi Zero nicely out of the way and keep the whole installation neat and tidy.

Now you know how to hack your letterbox, what are you going to set to happen when your post arrives? We'd love to see what this inspires you to make – get in touch via Twitter to show off your creations! □

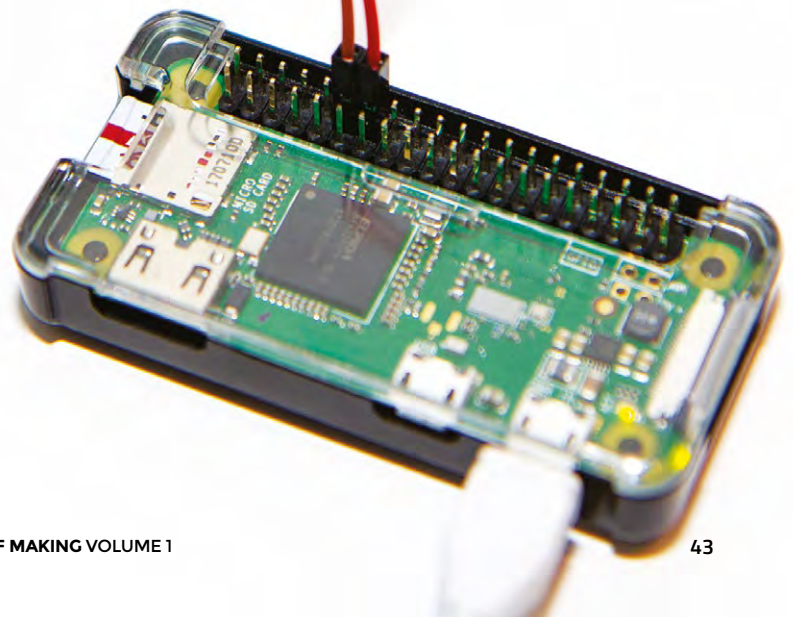

Building smart devices with Sonoff switches and Node-RED

Turn devices on and off the lazy way with Node-RED and a Raspberry Pi



David Floyd

GeekDayUK

David always loved technology, started with a KIM1, still had a Mac 128K (but hacked to 512K), and an original IBM PC. He loves the description 'polymath', and would like to live up to it.

WARNING

This project uses mains electricity. Make sure you understand the implications of this before undertaking this, or any other project, involving high voltages. Never connect your Sonoff device to the mains while connected to another computer or with the case off.

Sonoff produces a range of WiFi-enabled mains switches that are powered by hackable ESP8266 modules. They're available from Amazon, eBay, and direct-from-China shops for just a few pounds each.

They're in-line relays, which means that you connect them directly to the power cable of what you want to control, and they turn the power on or off. This way they can be used to link almost anything up to your network, provided that it can be controlled with a simple switch. Lamps (and other lighting) work really well, but anything that needs some input after being powered on will be more difficult.

In this tutorial we're going to look at how to control these using Node-RED, a browser-based programming system that's available for the Raspberry Pi, Windows, and macOS.

Node-RED programs are created with drag-and-drop nodes in your browser, joining them together with links. The nodes are effectively pre-written customisable subroutines. It is then easy to create programs that read sensors or website feeds, and then do different actions based on the results.

By default, the Sonoff relays are controlled via a phone app that uses the manufacturer's services, so the first step is to flash new firmware onto them to allow us to control them via our own Node-RED server instead.

There are a wide variety of alternative firmwares for the Sonoff devices, but we're going to use one called Tasmota (hsmag.cc/ZcTDuo), as it provides a comprehensive set of features and a good set of support documentation.

STEP 1 Uploading firmware

We are going to use some of the GPIO pins on the

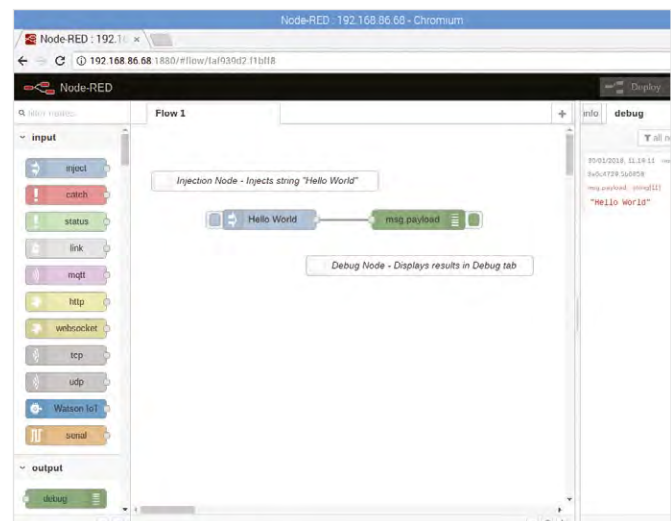

Above Hello World with Node-RED is an injection node that's used to create the data, and a debug node that displays the message

Raspberry Pi to communicate with the Sonoff board and load our new firmware.

First we need to enable the GPIO serial port. To do this, we need to edit the `/boot/config.txt` file.

In a terminal window, enter:

```
sudo nano /boot/config.txt
```

At the end of the file, add:

```
enable_uart=1
```

and then save the file.

By default, the serial port is used for the console communications (a hangover from serial terminals) and we need to disable this. To do so we will need to enter the following commands.

```
sudo systemctl stop serial-getty@ttyS0.service
sudo systemctl disable serial-getty@ttyS0.service
```

Finally, we need to edit **/boot/cmdline.txt**:

```
sudo nano /boot/cmdline.txt
```

Scroll down the file; we are looking to remove:

```
console=serial0,115200
```

Save the file and then reboot your Pi.

To upload the new firmware, we are going to use a tool called **esptool** ([hsmag.cc/IYvsve](https://github.com/letscontrolit/esptool)). This is available as a package for Raspbian, and can be installed using the command-line package-handling tool **apt-get**. To install **esptool**, we use the following commands in a terminal window:

```
sudo apt-get update
sudo apt-get install esptool
```

Now we can download the download Tasmota firmware from GitHub: [hsmag.cc/HRcXWQ](https://github.com/hsmag/HRcXWQ).

Here you will find a number of different language versions. We used the **sonoff.bin**, which is the English language version.

From this point onwards, following the tutorial will invalidate any warranty you have on your Sonoff device. Let's get hacking!

Now we are ready to open up the Sonoff case. Remember that this case is needed to protect users from mains voltages, so the project should be returned to this case before it's plugged in.

Remove the board and solder in some 5-pin female header strip (**Figure 1**). You could also use male headers if you prefer.

Now, using our four jumper wires, we need to connect up the Sonoff board to the Raspberry Pi.

Once we have the Sonoff connected to the Raspberry Pi, we need to get it ready to accept an upload. This is done by disconnecting the power Pin 1 on the Raspberry Pi and the Sonoff, then holding down the Sonoff button, and reapplying the power.

When reconnecting the power to the Sonoff, you may find that the Raspberry Pi reboots. This is because the power supply cannot supply enough power. In this case we found rebooting the Raspberry Pi, with the Sonoff button pressed until the reboot has completed, solved the problem. If this doesn't work, you may need a more powerful power supply.

We can upload the new firmware using the command:

```
sudo esptool -vv -cb 115200 -cp /dev/serial0 -ca 0X000000 -bz 1M -bm dout -cf /home/pi/Downloads/sonoff.bin
```

PIN CONNECTIONS FOR FLASHING THE FIRMWARE

Description	GPIO Pin	Sonoff Pin	Wire Colour (Figure 2)
3.3V	Pin 1	Pin 1 (Nearest to switch)	Red
TXD->RXD	Pin 8 (TXD)	Pin 2 (RXD)	Orange
RXD<-TXD	Pin 10 (RXD)	Pin 3 (TXD)	Brown
GND	Pin 6	Pin 4	Black

We used the **-vv** option so you can see the progress and any relevant error messages. The options to this command mean:

- **-vv**: Verbose mode
- **-cb 115200**: The baud rate of the serial connection
- **-cp /dev/serial0**: The serial port to use
- **-ca 0X000000**: Start address to upload to
- **-bz 1M**: Size of the flash chip
- **-bm dout**: Flash chip interface mode
- **-cf ...**: The file to upload

If all has uploaded successfully, we need to power-cycle the Sonoff device. →

YOU'LL NEED

- ◆ Raspberry Pi 3 running Raspbian
- ◆ Sonoff Basic WiFi switch
- ◆ Four jumper wires (Male-male)
- ◆ 5-pin male / female header strip
- ◆ Fine-tip soldering iron and solder

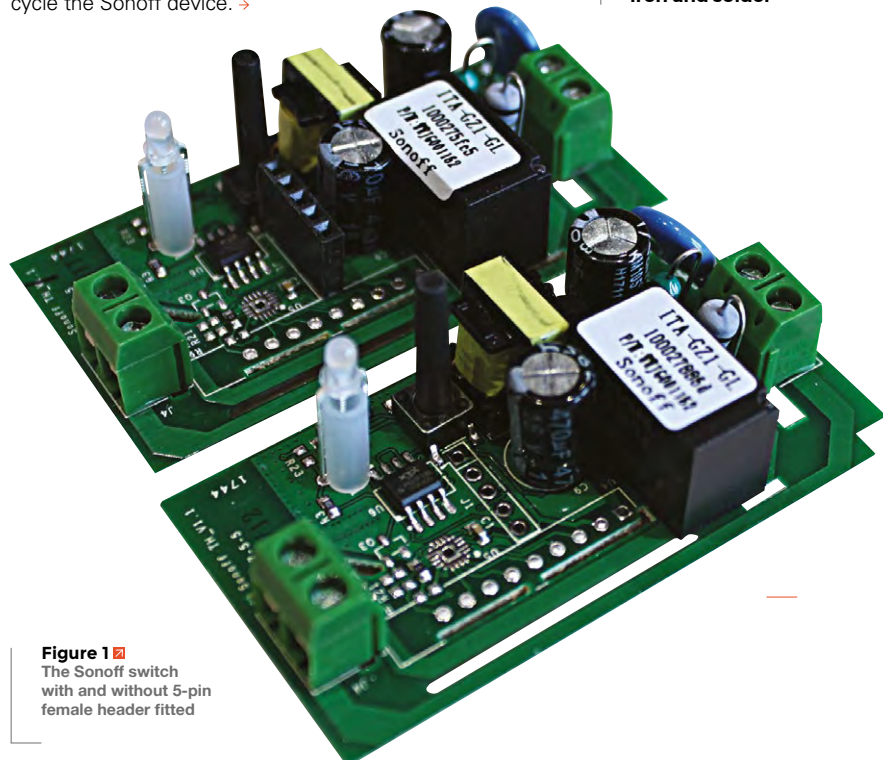

Figure 1 ■ The Sonoff switch with and without 5-pin female header fitted

TUTORIAL

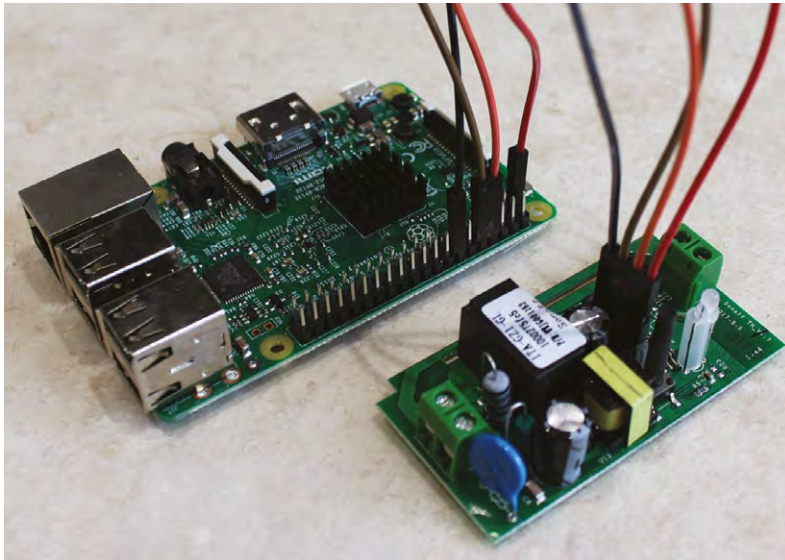

Figure 2 The Sonoff switches are programmable using the Raspberry Pi's universal asynchronous receiver-transmitter or UART

STEP 2 Tasmota WiFi setup

With the new firmware loaded and with the Sonoff-Tasmota device still powered by the Raspberry Pi, we are going to need to configure the Sonoff to connect to your WiFi. We start the process by pressing the button on the Sonoff four times quickly – this will put the Sonoff into WiFi access point mode.

Remember that you should never connect your Sonoff device to the mains while connected to another computer or with the case off.

The LED on the Sonoff will blink during configuration; a single button press at this point will abort the process if you need to start again. See hsmag.cc/fmquaD for more information on this and other configuration options.

On your Raspberry Pi, click on the WiFi icon to display the list of local WiFi access points; we are looking for an access point called sonoff-????, Where ???? is a four-digit number for your device. You may need to refresh the list a few times before it joins the list, but once it is available, click on it to connect.

Once connection is established, open your web browser and enter the IP address **192.168.4.1** and press **RETURN**. It should open up a page called Sonoff Basic Module.

On this page you can enter your required WiFi network name (SSID), and password. In our setup this is `homenetG`, but you need to enter your own here. You

ALEXA AND WEMO EMULATION

If you'd rather control your devices with your voice, you can link your Sonoff devices to an Amazon Echo (or other Alexa device), rather than using Node-RED. With the Tasmota firmware, you can do this using Belkin WeMo emulation. You will find this option in the 'Configuration > Configure Other' menu. Do be careful with your selection on the 'Friendly Name', as this will be the name you need to use with Alexa to control the device.

We found 'Alexa Desk Lamp on' and 'Alexa Desk Lamp off' work perfectly.

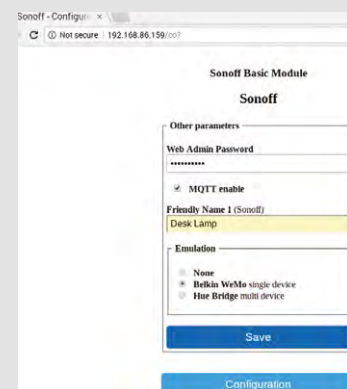

can also enter a second alternate SSID and password if needed. Now press the Save button and the device will restart after a few seconds.

If this all goes horribly wrong, just hold down the button on the Sonoff device for over four seconds, and you can then restart this part of the process.

Now reconnect to your local WiFi network and with the new device hopefully connected, we now need to find its IP address so we can talk to it.

The process for getting this depends a little on your network setup. Most home routers use DHCP to allocate a unique IP address to each device, and you can see this by logging into the router's web interface (this is often found at <http://192.168.0.1>, though you may need to check your router's manual if this doesn't work).

If you can't get the IP address details from your router, you can scan your network to find all the devices attached to the LAN using software such as Fing (hsmag.cc/uMHJIA), or an app on your smartphone.

Our device was allocated **192.168.86.159**, but yours will probably be different. Enter the IP address of your device into your browser and you should then get the webpage shown in **Figure 3**.

// You can add more Sonoff switches to your network – just remember that each one will have a different IP address and you'll need to create separate HTTP Request nodes for each one



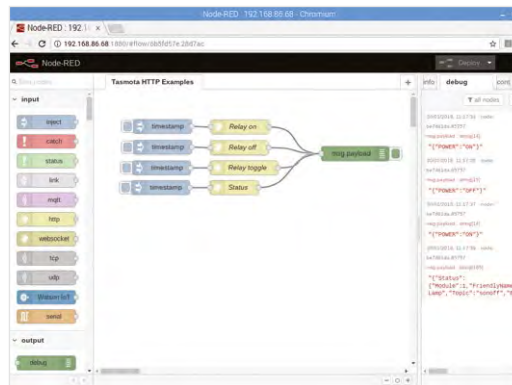

Far Left - Figure 3 ♦
The web-based configuration for the Tasmota firmware

Left ♦
Node-RED set up to control our Sonoff relay

STEP 3

Remote control from Node-RED

You can control the switch using the Tasmota website, but you can get a little more power by linking it into a programming environment. You can use any that can make HTTP requests, but we'll be using Node-RED, as this allows us to easily create flow-based programs that can turn things on or off based on inputs.

While Node-RED is available for a variety of devices, we'll be using the Raspberry Pi (Node-RED comes pre-installed in the latest version of Raspbian). Make sure you're using an up-to-date image, then launch Node-RED with:

```
node-red-start
```

The web-based interface will now be available at **http://localhost:1880**. Here, you'll have the ability to drag and drop nodes into flows that perform actions.

We'll set up our basic Node-RED test using injection nodes, HTTP request nodes, and a debug node. The

injection nodes are used to first trigger the action. You'll need four injection nodes, with each one linked to a HTTP Request node. The link in the HTTP Request should point to a command on the Sonoff. The links are:

- `http://<ip-address>/cm?cmd=POWER ON`
- `http://<ip-address>/cm?cmd=POWER OFF`
- `http://<ip-address>/cm?cmd=POWER TOGGLE`
- `http://<ip-address>/cm?cmd=STATUS`

These, as you may have guessed, are to turn the relay on, off, toggle the state, and get the status, respectively.

Linking these to a debug node allows you to see what's going on. This is the basic setup for controlling the Sonoff via Node-RED, and you can build it into any project you like. This will let you control your relay, but to make it do any work you'll have to put it back in its case, then put it into the powerline of the device you want to control. That means cutting the power cord and wiring it up following the manufacturer's instructions – remember that you're using mains voltage, so don't plug it in until you're happy that it's securely housed and safe. Consult a suitably qualified or experienced person if you're not sure.

You can add more Sonoff switches to your network – just remember that each one will have a different IP address, and you'll need to create separate HTTP request nodes for each one. Using these, you can create complex flows to turn your devices on and off using any form of input you can get into Node-RED. □

SECURITY

The Tasmota web interface allows you to add a password to your device, and then you need to append 'user=admin&password=password' to your HTTP commands. For example:

```
http://<ip-address>/cm?user=admin&password=  
=password&cmd=POWER ON
```

However, the security conscious of you will notice that this is transmitted on the plain-text HTTP protocol, so this doesn't really add much security. Essentially, any device on your WiFi network will be able to see these requests and take control of your Sonoff switches.

How much this concerns you depends on your attitude to security and what devices the Sonoff switches are powering. We would recommend running the switches (or, for than matter, any smart devices) on a separate WiFi network and bridge the two using a trusted, secured device, such as a Raspberry Pi running Node-RED.

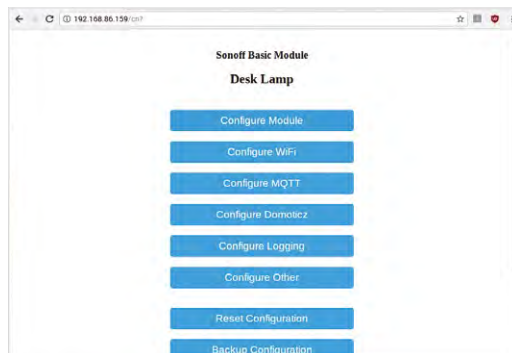

Left ♦
There are more features to Tasmota than we've explored here, including the ability to control the hardware with MQTT

ENJOYING THIS BOOK? FIND MUCH MORE IN HackSpace

CIRCUIT PLAYGROUND EXPRESS*

WORTH
£25

WITH 12-MONTH PRINT SUBSCRIPTION



FROM JUST
£55



**12-month
subscription
from £55:**

- UK: £55 per year
- EU: £80 per year
- US: £90 per year
- RoW: £95 per year

* Circuit Playground Express offer applies to 12-Month Print Subscription only. This is a limited time offer and the publisher reserves the right to cancel it at any time.

Visit: hsmag.cc/subscribe

SUBSCRIBER BENEFITS ↓

SAVE UP TO 35% ON THE PRICE
FREE DELIVERY TO YOUR DOOR
EXCLUSIVE OFFERS AND GIFTS
GET YOUR COPY BEFORE STORES

OTHER WAYS TO SUBSCRIBE

Rolling subscription from £4 a month:

- Quick and easy to set up
- Cancel any time
- No long-term commitment
- No large up-front cost

Digital subscription from £2.29 a month:

- Direct to your mobile
- For both Android & iPhone
- No delivery fees
- Back issues available



Visit: hsmag.cc/subscribe

Make your own 8-bit synths with Arduino

Getting started with the Mozzi library to get your Arduino wailing



Chris Ball

[@ChrisBallMidi](#)

Chris Ball is a technologist working in Manchester, UK. He has worked on a variety of interactive art installations. You can visit his site at chrisballprojects.co.uk

YOU'LL NEED

- ◆ **An Arduino** (preferably Uno, although others are possible)
- ◆ **Breadboard**
- ◆ **470 Ω resistor**
- ◆ **Tactile button**
- ◆ **4 × 10 kΩ linear potentiometers** (usually marked B10K)

Right

Our final synth, with the four potentiometers we need to play with to create the sound of the future

So, you've got your first Arduino, and you've tried a few basic projects. Maybe you've got an LED blinking and now you're struggling to find a project that's a little more creative. Look no further, we've got you covered! You may have achieved some basic bleeps and bloops with the built in `Tone()` function, but we'll be doing some much more advanced digital synthesis.

Digital synthesizers are very different from their analogue counterparts. Instead of a complex collection of diodes, amplifiers, oscillators, and other esoteric audio electronics, they mainly use processing

power to generate waveforms and effects. Digital synths have other benefits too, but their main strength is that once set up, they're extremely reconfigurable; you don't need to rebuild your synth to change its sound, just reprogram it.

Throughout this tutorial we'll be using the Mozzi library to create a variety of sounds. The library is capable of generating complex waveforms, audio effects, and playing short samples, all from the modest hardware in an Arduino. We'll be using it to create a basic FM (frequency modulation) synthesizer.

We'll get started with the absolute bare minimum for a Mozzi-based sketch. Make sure you've installed

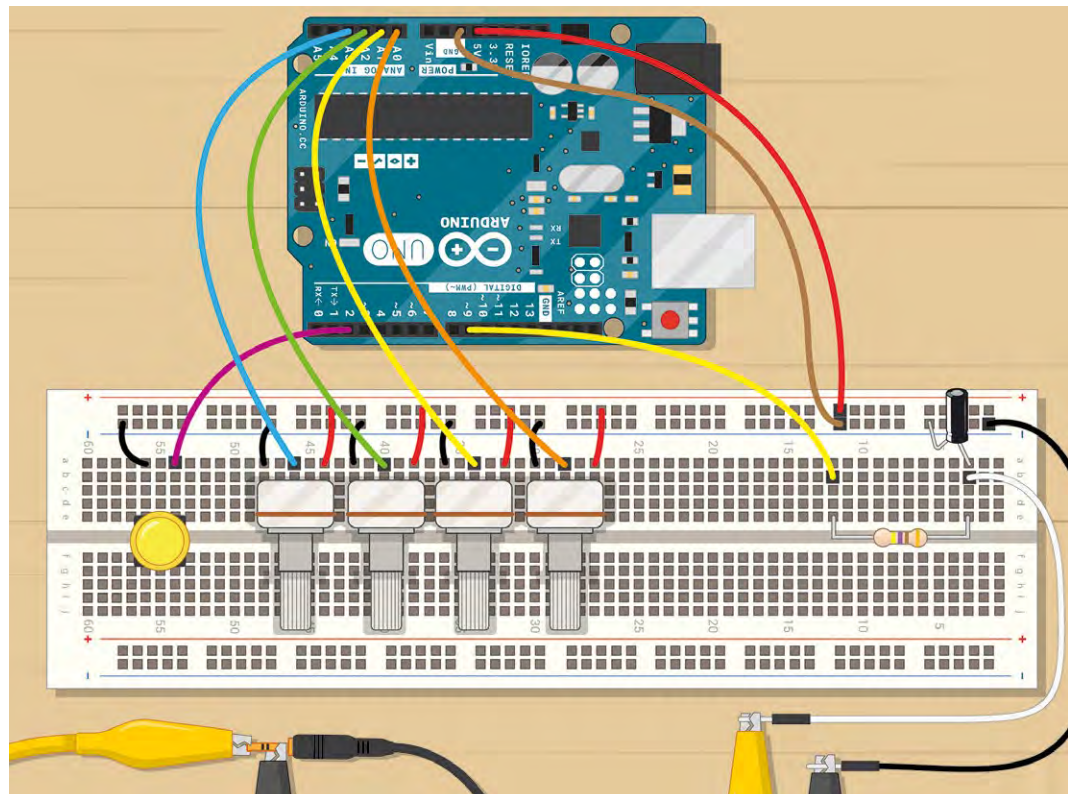

the Mozzi library, then start your Arduino environment and open the example under File > Examples > Mozzi > Basics > Sinewave. This is a sine wave generator, which is pretty much the digital audio equivalent of a 'Hello, World!' program.

Here you'll see the basics of a Mozzi program, and you might notice it has a slightly more complex structure than your usual Arduino sketch. Let's ignore that for now, and get making some sound. Upload the code to your Arduino. If all is well, a sine wave will be generated on pin 9, and we just need to listen to it.

To connect the Arduino to our amplifier/earphones we need to connect the following:

Arduino pin 9 → 470 Ω resistor → Audio jack tip (the resistor is to help protect pin 9)
 Arduino GND → Audio jack base

If all's well, you should hear a sine wave at 440 Hz. If you have no sound, check your volume, connections, and that the sketch has uploaded successfully.

If you've had some success, we'd recommend at this point that you take a look at some of the other examples the Mozzi library has to offer. This will give you an idea of what it's capable of, but bear in mind that some examples expect extra hardware.

Back to the sine wave generator: we'll be breaking down the elements of this sketch fairly thoroughly, as knowing the basics of how Mozzi works will enable you to make more exciting changes later.

First, we'll take a look at the includes. This is where we add in the required files from the Mozzi library, and you should see three includes: **MozziGuts.h**, **Oscil.h**, and **tables/sin2048_int8.h**.

MozziGuts.h is the main library required for doing anything with Mozzi. This file will adapt your Arduino for use as a synth, by taking over some timers and setting up some fast sampling methods.

Oscil.h is simply a template for an oscillator. Any sound requires a repeated change in voltage, or air pressure; an oscillation. This file tells Mozzi how to create an oscillator from a lookup table.

tables/sin2048_int8.h is the lookup table we'll be using to make a sine wave. A lookup table is often used where calculating the values of a function (in this case, a sine wave) would take too long. We simply pre-calculate all the values and store them in memory.

When we need them, we can simply 'look them up', hence the name lookup table.

We then have a line:

```
Oscil <SIN2048_NUM_CELLS, AUDIO_RATE>
aSin(SIN2048_DATA);
```

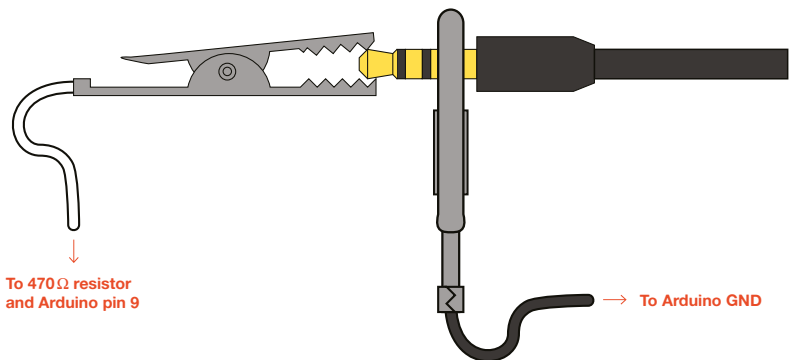

This is a little like saying, "Create a sine wave oscillator called aSin, using the table I mentioned before." We also have the line:

```
#define CONTROL_RATE 64
```

Which means we intend to update our controls (our potentiometers and buttons) 64 times per second. Mozzi asks for control rates to be powers of two (e.g. 2, 4, 8, 16, ...)

To continue to our main functions: in **setup()** you'll see two commands. The first, **startMozzi(CONTROL_RATE)**, will start the Mozzi engine, and the second, **aSin.setFreq(440)**, will set the frequency (or pitch) of our oscillator. 440 Hz is middle A (so if you only get this far, at least you can get your band in tune).

Typically, when writing a Mozzi sketch, you'll avoid putting anything in **loop()**, except the function **audioHook()**. This function will calculate samples (little chunks of audio data) ready to be written to our output. So where do we put our code? You'll notice, apart from the usual **setup()** and **loop()** functions that we have two more: **updateControl()** and **updateAudio()**.

updateControl() is where we put the changes we want to happen at our control rate (64 times per second). This will be things like reading our potentiometer values, button states and other tasks that don't need to happen too often. In this sketch, nothing like this is required, so the function is empty.

updateAudio() is the function that **audioHook()** will run repeatedly – it calculates our audio samples and stores them in a buffer to be sent to pin 9 later. You can see within this sketch the code: →

Above ♦
 How to connect crocodile clips to an audio jack

INSTALLING THE MOZZI LIBRARY

From sensorium.github.io/Mozzi you can click on the download link. This will take you to an optional donation page where you can help the author of the library out, if you choose. You'll then be taken to the GitHub project page for Mozzi. Click the 'Source Code .zip' link, download the zip file, and extract the contents to your **Arduino/libraries** directory (this is usually in your **documents** folder).

Your file structure should then look like this:

Documents/Arduino/Libraries/Mozzi-1.0.3 (although you may have a different version).

TUTORIAL

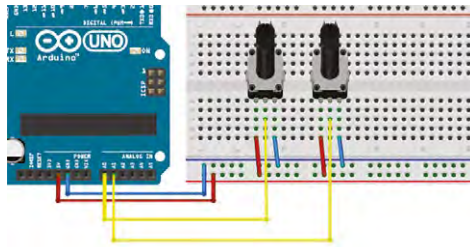

Figure 1 Connecting two pots to your Arduino

`return aSin.next();` which simply means to send the next sample for this oscillator to the buffer.

Let's make a couple of changes to the way this works. We'll add one pot (potentiometer) to control frequency, and a second pot to control volume.

Connect two pots to your Arduino (**Figure 1**). Each pot will have one side connected to 5V, the other side connected to GND and the middle (wiper) to an analogue input. We'll use analogue inputs A0 and A1.

Add the following lines of code before `void setup()`:

```
int pot0, pot1;
int volume, frequency;
```

These will be the variables where we'll store the pot values, and the frequency and volume values they will control.

Add the following lines of code inside your `updateControl()` function:

```
pot0 = mozzianalogRead(A0);
pot1 = mozzianalogRead(A1);
frequency = pot0 + 50;
volume = map(pot1, 0, 1023, 0, 255);
aSin.setFreq(frequency);
```

The first two lines will store our pot voltages as variables, `pot0` and `pot1`.

The third stores the value of `pot0 + 50` to a variable called `frequency`. We've added the `+50` to prevent the frequency becoming too low to hear.

The fourth line will store the value of `pot1` to a variable called `volume`, but will scale it in the process to be between 0 and 255 (instead of 0 and 1023).

The last line will set the frequency of our oscillator to the value in the `frequency` variable

This covers changing our frequency, but we need to make one last change in `updateAudio()` for the volume control to work.

Change the line:

```
return aSin.next();
```

to:

```
return (aSin.next()*volume)>>8;
```

This line may look confusing, but it's very similar to multiplying the output by a value between 0 and 1. It's good to get used to calculating this way as it's significantly faster with integer values on an Arduino, and we need speed to calculate all our sample values.

If you upload these changes, you now have a basic synthesizer! You should be able control pitch with pot 0 and volume with pot 1.

So perhaps you've played that for a while and become bored already. This was bound to happen – it's only a simple synthesizer. Let's try adding another sine wave oscillator, and another potentiometer to control it. To add another potentiometer, you can repeat the connection pattern as before, with our middle wiper pin wired to A2 on the Arduino. We already have the sine wave lookup table we need, so we can do this simply by duplicating the line:

```
Oscil <SIN2048_NUM_CELLS, AUDIO_RATE>
aSin(SIN2048_DATA);
```

You'll need to give our oscillators distinct names, so we should change this to:

```
Oscil <SIN2048_NUM_CELLS, AUDIO_RATE>
aSin1(SIN2048_DATA);
Oscil <SIN2048_NUM_CELLS, AUDIO_RATE>
aSin2(SIN2048_DATA);
```

We'll add and change some variables too:

```
int pot0, pot1, pot2;
int frequency1, frequency2, volume;
```

Our `updateControl()` function will become:

```
pot0=mozzianalogRead(A0);
pot1=mozzianalogRead(A1);
```

QUICK TIP

The '>>' and '<<' symbols are called bitshift operators, and they are a very fast way of dividing or multiplying by 2. The '>>8' is a little like saying "divide by 2, 8 times". If our volume value was 200, you could think of this line as `Output × (200/256)`.

DIGITAL TO ANALOGUE WITH PWM

You might have realised that we are using pin 9, a digital pin, to do the job of an analogue output – how does this work? We are using pulse-width modulation (PWM). Simply put, if we want to approximate 2.5V with a 5V digital output, we switch the digital pin high for 50% of the time. 1V would be 20%, 2V 40%, and so on.

PWM is most commonly used for making lights (particularly LEDs) appear at different brightnesses or motors run at different speeds, all by switching a constant voltage on or off.

This approach does have significant downsides, though – mainly that it will introduce a lot of noise at your modulation frequency. Not a problem for motors or LEDs, but your ears will probably notice straight away.

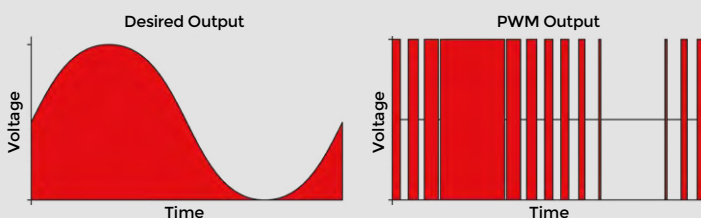

```

pot2=mozziAnalogRead(A2);
frequency1=pot0+50;
frequency2=pot1+50;
volume=map(pot2, 0, 1023, 0, 255);
aSin1.setFreq(frequency1);
aSin2.setFreq(frequency2);

```

And our `updateAudio()` code will be changed also:

```

return volume*((aSin1.next()+aSin2.next())>>1)>>8;

```

Our two sine waves, when added together, could add up to a number higher than our PWM output can reproduce. In audio circles this is called ‘clipping’ and is generally avoided (unless you’re intentionally after a distorted sound). We’ve prevented this here by dividing the output by two.

The above changes should result in two controllable sine waves on pots 0 and 1. You may even be able to get some interesting ‘throbbing’ if you pitch the notes close together – this is called ‘beating’ and is caused by interference between the two frequencies.

To develop the synth further, we’ll introduce frequency modulation (FM). This means we’ll use the output of one sine wave to control the frequency of another, resulting in varied timbres.

We’ll also be making some changes to our hardware: adding another potentiometer; and introducing a push button to trigger the audio.

If you make these changes to the circuit, and upload the code from hsmag.cc/uVQPIe, you should have yourself an FM synthesizer!

The magic happens in two lines. This one, in `updateControl()`:

```

aSin2.setFreq(frequency2);

```

And this line, in `updateAudio()`:

```

aSin1.setFreq(frequency1+(amount*(aSin2.
next())>>8));

```

The first sets the frequency of our modulation, and the second uses that to control the frequency of our main waveform. There is also an `amount` control that will multiply our modulation, with some interesting effects. Remember, now you’ll need to push the trigger button to hear sound! Try changing some of the numbers in this code and see how they affect the output.

So, you should have a basic 8-bit synthesizer, but more importantly, an idea of how to use the Mozzi library to develop it further. Mozzi has a huge selection of basic waveforms, some audio effects, and it’s extremely well documented, with great examples. If you feel lost at any point, you can always check on the website. □

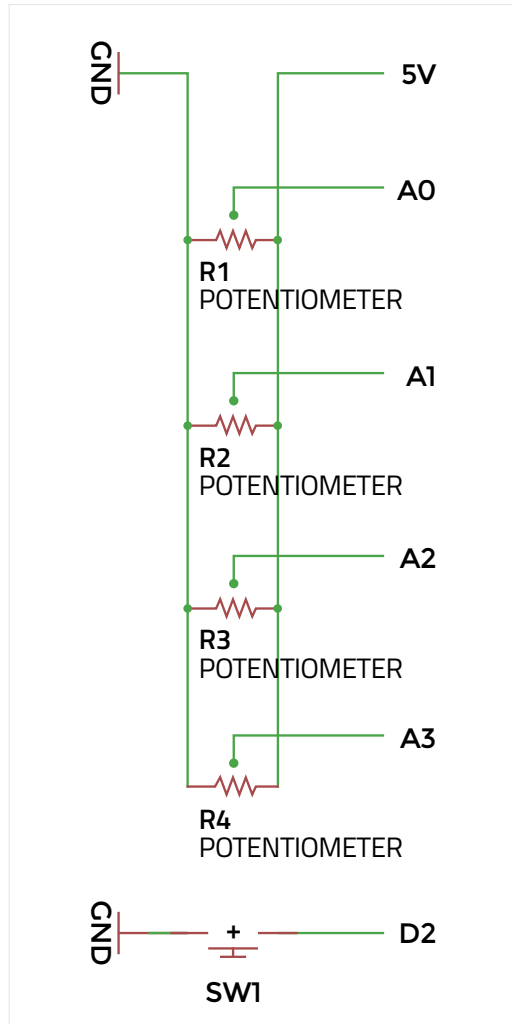

QUICK TIP

Having problems getting the first example working? There’s a much more thorough walkthrough at hsmag.cc/AwksSP

Left □
The final circuit diagram for the breadboard

OTHER ARDUINO AUDIO PROJECTS

ElectroSmash PedalShield: This is a kit designed to sit on top of an Arduino Due and turn it into a general-purpose guitar effects pedal. It has some basic examples available, and a forum with many more. Electrosmash.com/pedalshield

Arduotouch: International hacker Mitch Altman has created an Arduino-based synth project called Arduotouch, built on a fantastic library by himself and Bill Alessi. The library by itself is great to mess around with, although it may require an experienced Arduino user. cornfieldelectronics.com/cfe/projects.php

Teensy Audio Board: This hardware for the Teensy 3.1/3.2 and the accompanying audio library get an honourable mention simply because it’s so fully featured. Not strictly Arduino, but Arduino-like. pjrc.com/teensy/td_libs_Audio.html

There are many more useful libraries in the [Arduino Library List \(playground.arduino.cc/Main/LibraryList\)](https://playground.arduino.cc/Main/LibraryList) under the ‘audio’ section.



Waterwheel pump

By Nick Watson

backtotheland.co.nz

My partner and I moved to a small farm from New Zealand's big smoke, Auckland, four years ago. Since then, we've come to understand the farmer's plight – doing more with less. One such venture was constructing a waterwheel and piston pump to replace the worn-out petrol-powered pump down by the river, which supplied water to our stock tanks. We needed to pump approximately 2000 litres per day, 20 metres high.

I first considered a hydraulic ram pump or a Wirtz wheel, but the calculations seemed dubious for our setup. So, I set out to craft a simple waterwheel-driven piston pump, with only an instinct for how such a thing might function. Surprisingly, the hare-brained prototype worked. The waterwheel is comprised of wood with metal fins. An iron wheel at the end of the axle drives a simple Scotch yoke mechanism, which pushes the piston. I didn't want to buy expensive check valves for the pump, so I crafted my own out of rubber bouncy balls and PVC couplings. Works like a charm! ▣



Right ▣
 First rule of farming:
 if something's free
 (such as the energy in
 this stream), use it!



Marvellous mechanical music box

Build a touch-activated music box with no coding



Andy Clark

📍 @workshopshed

After an aerospace apprenticeship and electronics degree at Imperial College, Andy took a job as a software engineer. For the last ten years he's been making and repairing in a shed at the bottom of the garden. You can see more of his exploits at workshopshed.com

Coding is great, because it gives your projects flexibility to change. However, for simple well-defined systems, dedicated hardware can do the job just as well.

This project uses a dual version of the classic 555 timer to control the system. A modified micro servo drives a mechanical music mechanism and the wooden box acts as a resonator to amplify the sound. A touch sensor module triggers the timer.

To make the box we need six pieces of wood. I'm using 10mm prepared pine from a local DIY store. It comes smooth all over, but you need to watch for warping when you buy. To save time, I bought pieces that were the size of the box I wanted to make.

Start with the top and bottom, as those are the largest pieces. The length needs to be the length of the servo plus music box together, plus 2 x wood thickness, plus 2 x 3mm for the lining. Best leave a little extra so the servo is not pressing against the

wall. Also allow a few mm for sanding. The width is the width of the servo plus space for the servo arm to rotate, plus 2 x wood thickness, plus 2 x 3mm lining.

The sides need to be the length minus 2 x thickness. The height of the sides is simply the internal depth of the box. Again, the servo needs space to rotate.

Finally, the ends are sized to fit but should be length minus 2 x thickness and the width minus 2 x thickness. You need to ensure that the ends are at right angles to the sides.

TURN BLOCK INTO BOX

Once the glue is dry, sand your block all over, ensuring that the ends are flat and smooth. Add a small bevel to the edges of the box to make it more pleasant to handle.

With a square and a ruler draw a straight line all the way around the box about two thirds of the way

EXPERT TIPS

I like to use a tool called a Surform, which looks like a small cheese grater. This is good at removing wood a bit faster than sanding alone and can be used to quickly get the wood to the correct size. Take care with the ends as you might cause the wood to splinter or 'break out'.

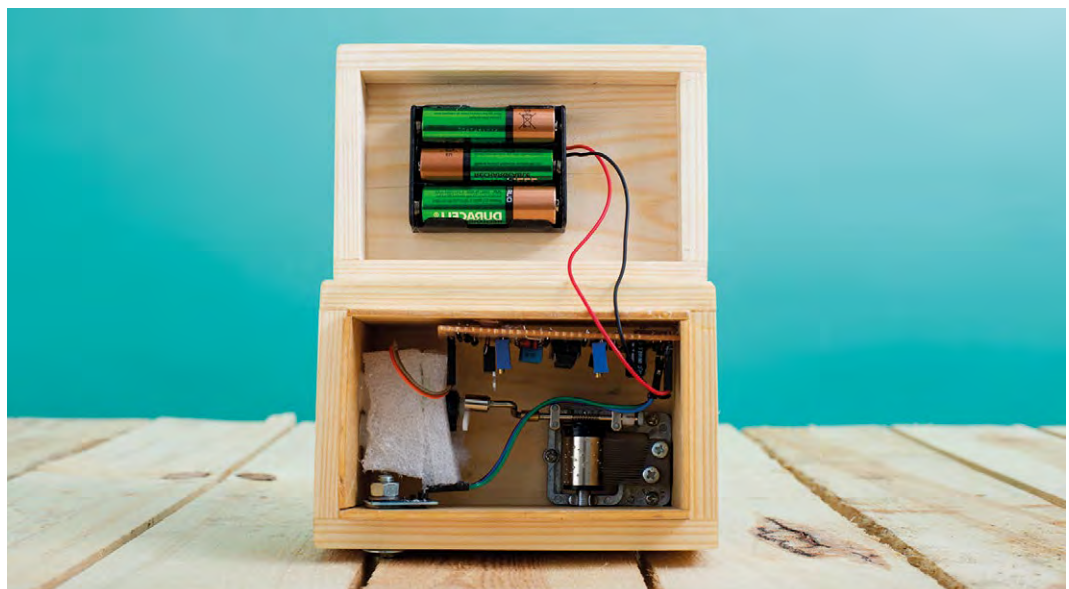

Right ◆

A good box like this can be filled with anything, but we prefer to fill it with MUSIC

QUICK TIP

If you want to drive a bigger motor, then a power Darlington transistor can be used.

A protection diode ensures that the transistor is not damaged by reverse current from the motor. Ensure that your motor is wired so that it rotates in the opposite direction to the music box mechanism.

The last component to mention is the 100µF capacitor. That is connected across the supply to ensure that the voltage does not suddenly drop each time the motor turns on. Without this you may find that the sensor and timer behave erratically.



up the side. Then, carefully saw along that line to separate the lid from the box. Sand away the saw marks, but try not to sand too much. Keep checking that your two halves still match nicely.

The last assembly step for the box is to add the lining. This is made from 3mm ply. Cut this to size so that about 10mm protrudes above the base of the box. Ensure that all of your pieces are the same size and don't forget to allow for the thickness when measuring. Finally, you can finish the box with varnish or Danish oil to give your box protection from the elements and to show off the grain. Two or three coats is recommended.

Once the varnish is dry, drill a hole in the front on one side for the coach bolt. Thread the bolt into the hole and add a washer. Tighten with a nut so that the

square part of the coach pulls tightly into the wood. Now remove the nut.

Drill a hole in the middle of the sensor pad. Thread this onto the bolt, followed by the second washer. Finally, add a nut to secure. You can test the sensor works using the battery pack and a multimeter to see the output voltage.

SERVO SURGERY - WARRANTY VOIDED

A servo consists of a motor, gearbox, position sensor, and a control circuit. For the music box, we just need the motor and gears. The control circuit can be removed and the gears modified to allow continuous rotation.

A micro servo case is held together with small but long screws; remove these and any stickers →

YOU'LL NEED

- ◆ Wood plank
- ◆ 3 mm ply
- ◆ Coach bolt or similar
- ◆ 2 × washer
- ◆ Hand-cranked music box mechanism
- ◆ Micro servo
- ◆ Foam packing material
- ◆ TTP223B capacitive touch sensor module with the sensor pad separate from the electronics
- ◆ 556 dual timer
- ◆ 14-pin DIL socket
- ◆ 1 × signal diode
- ◆ 1 × rectifier diode
- ◆ 2 × 100 kΩ trim pot
- ◆ 1 × BC549 general-purpose transistor
- ◆ 1 × TIP31 power transistor
- ◆ 1 × 0.1 µF capacitor
- ◆ 3 × 10 nF capacitor
- ◆ 2 × 100 µF polarised capacitor
- ◆ 1 × 100 kΩ resistor
- ◆ 4 × 1 kΩ resistor
- ◆ Battery box
- ◆ 3 × AA battery
- ◆ Connectors
- ◆ Stripboard
- ◆ Solder
- ◆ Wire
- ◆ Danish oil or varnish

TOOLS

- ◆ Saw
- ◆ Fine cross-head screwdriver
- ◆ Wood glue
- ◆ Drill and drill bits
- ◆ Multimeter

QUICK TIP

Do not try to drive the motor from the output gear, it could strip the teeth off the gears.

Below ◆ The output gear has wider teeth so it can take more torque

A ROUGH GUIDE

Sandpaper comes in different grades or grit sizes, represented by the numbers on the back. For shaping wood, a low number such as 80 grit is good. For smoothing and finishing wood, a higher grade such as 180–240 is better.

that stop you opening the case. Open the case slowly as the parts may fall out.

Open the back of the servo and pull out the small circuit board. Cut or desolder the three wires connected to the potentiometer. Cut or desolder the two wires that are connected to the motor. Remove the circuit board. Solder a 0.1 µF capacitor across the motor terminals and attach two wires that lead out of the case.

Close up this side of the motor and open the opposite side. The main output gear has two features that stop it from rotating continuously. The first is a peg on the underside. This will clash with the other gears if it rotates too far. The second is a

|| A modified micro servo drives a mechanical music mechanism and the wooden box acts as a resonator to amplify the sound

|| The first timer is configured in

flat area on the potentiometer shaft that aligns with a D-shaped hole in the gear. Carefully round off the hole in the output gear: you can do this with a small flat-bladed screwdriver. Cut off the peg. Replace the gear on the gear train and rotate the second gear in the train to check that it can complete a full revolution.

THE ONLY THING BETTER THAN A 555 TIMER IS TWO 555 TIMERS

The control circuit for the music box uses a 556 integrated circuit, which is two 555 timers in a single package. The first 555 is running in Monostable mode and needs a 'low' signal to trigger it, but the sensor module provides a 'high' signal when it is triggered. To invert this signal we can use a simple transistor switch to connect the input to low and a resistor to pull it high when the transistor is turned off.

The first timer is configured in 'Monostable' mode. This means that, once triggered, the output stays high for a period of time before resetting. The period is defined by the resistors and capacitor connected to the threshold and discharge pins. The recommended values will set the period to around 15 seconds, which should be enough for a couple of plays of your music. The trim potentiometer will allow this to be fine-tuned.

When the output of the first timer is high, it will enable the second timer via its reset pin. This is configured in 'Astable' mode. In this mode the timer will send out a series of pulses. The frequency of these pulses is defined by the resistors and capacitor connected to the threshold and discharge pins. The trim potentiometer and diode allow the pulse width of these pulses to be adjusted. This is known as pulse-width modulation or PWM and can be used to control the power to the motor and hence the speed of rotation.

As the motor takes more current than the 555 can provide, a power transistor is used to turn the current on and off to the motor.

PUTTING IT ALL TOGETHER

When building the stripboard, you can design using squared or lined paper and pencil. It is also possible to use an electronics CAD package such as KICAD to design your board.

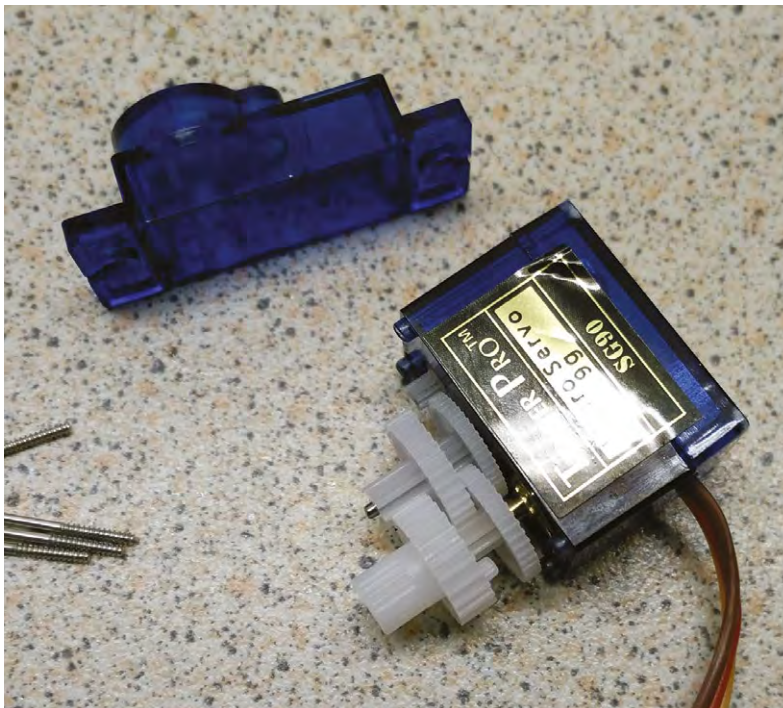

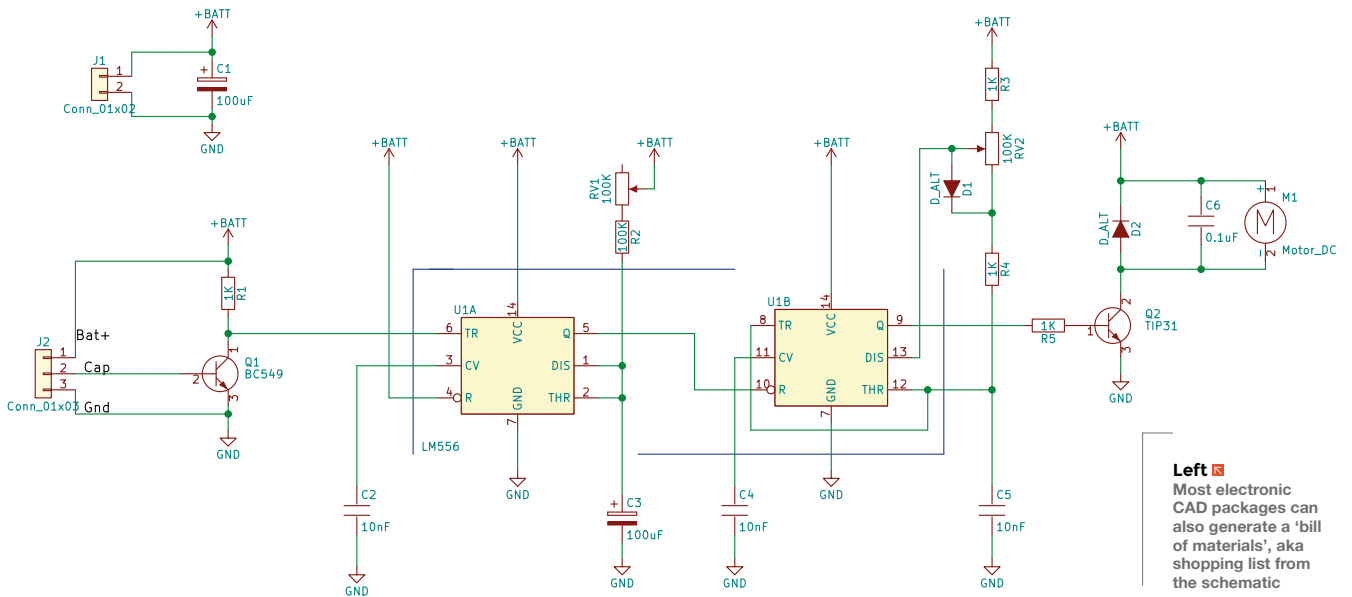

QUICK TIP

Some modern microcontrollers come with built in capacitive sensors, so you could design an equivalent circuit with one of those.

Cut the tracks as per the diagram, remembering that their positions will be flipped when you turn the board over. Solder the wires and small components first, along with the DIL socket. Then add the taller capacitors followed by the transistors. It is usually worth using connectors to attach any external components such as the battery pack, sensor, and motor.

Position the music mechanism and servo in the base of the box. Ensure there is space for the servo arm, and the music mechanism handle can rotate without hitting the sides of the box. Secure the music mechanism with screws.

The motor needs to be at the right height and position so the output shaft aligns with the axis of the music mechanism handle. Cut a rectangle in the foam to fit the servo. Secure the foam into the box using hot glue.

Test that the sensor activates the motor. Adjust the duration and speed trim pots so that the music will play at a suitable pace. You can now enjoy your music box. □

QUICK TIP

The sensor module will take a few seconds between each touch to recalibrate.

Right Include packing under the clamps to stop them marking the wood



Silver soldered storage box

Protect your tools from furry intruders



Andy Clark

@workshopshed

After an aerospace apprenticeship and electronics degree at Imperial College, Andy took a job as a software engineer. For the last ten years he's been making and repairing in a shed at the bottom of the garden. You can see more of his exploits at workshopshed.com

Mice have a tendency to nibble on power cables. Some people say it's because they're attracted to plasticisers, but maybe they're just mistaking the orange cable for cheese. Whatever the case, it can be important to protect your power tools from these hungry visitors, and a metal storage box should do just that.

The box is designed to be folded from thin sheet metal and silver soldered together. The folds add to the strength of the box and stop it from flexing. The design of the box incorporates tabs or flanges. These provide the silver solder joints a large surface area for bonding.

CAD DESIGN FOR SHEET METAL

The box and lid were created using the sheet metal feature of Fusion 360 which was released earlier this year. You can download a trial copy of the software and then license that as a student,



Above Our tools are stored safely away from any hungry animals

enthusiast, or start-up for a free license. Fusion 360 requires an internet connection and an AutoDesk account to work. Your work is saved to the cloud although the software is installed and runs locally – hsmag.cc/QtvwtU.

Before starting, it's worth setting up the 'Sheet metal rules' which define the properties of the material you are working with. These control how the metal bends and how much material the CAD package includes for the folding. When metal is bent, the metal on the outside is stretched and the metal on the inside is compressed. How each metal behaves is defined by the k-factor and the software uses that and the parameters of the bend to determine the characteristics of the fold. The default for steel sheet is 2.5mm thick, so we created a new rule for 0.5 mm.

Once you've defined your rule, sketch a rectangle for the base of the box on the X-Z plane. Switch to the sheet metal workspace and create a flange representing the first side of the box. When creating the first side you'll be prompted to choose

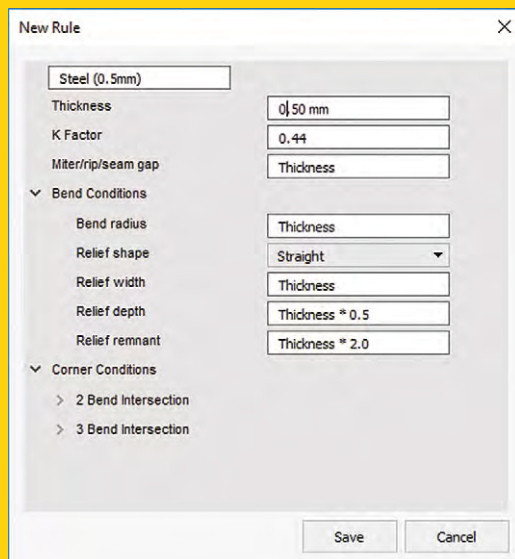

Right Rules control how the metal bends

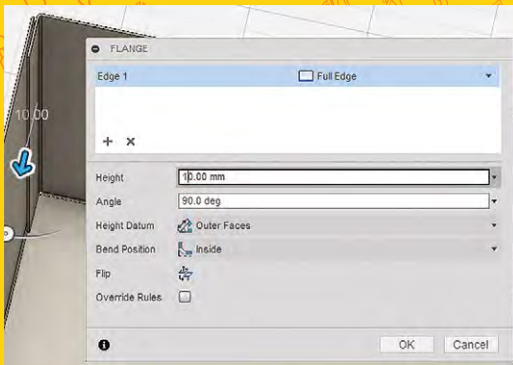

Above ▾
Tab is inside the other flange

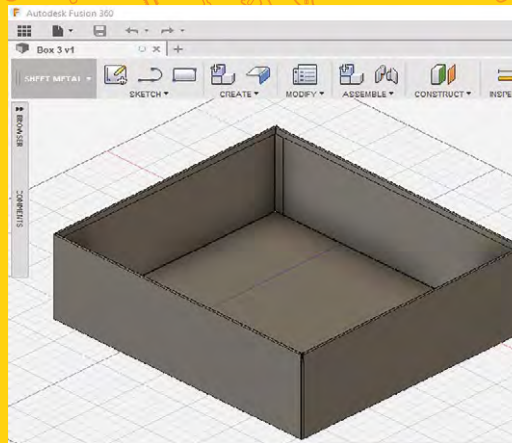

Left ▾
You can render the final model to make sure it looks as you expect

YOU'LL NEED

- ▾ 0.5 mm sheet steel (not zinc-coated)
- ▾ Handles
- ▾ Silver solder
- ▾ Flux
- ▾ Pop rivets for handles
- ▾ Safety equipment
- ▾ A scribe
- ▾ Layout blue or a wide-tipped permanent marker
- ▾ Ruler and square
- ▾ Hacksaw
- ▾ File
- ▾ Clamps
- ▾ Emery cloth
- ▾ Gas Torch

a rule. Choose the rule for your chosen material. Rotate the workspace and create the next flange for the next side. This one needs to be slightly narrower so there's room for the tabs. Adjust the size using the edge type option, the symmetric option allows you to define the length from the middle to one side.

Next, create another flange from the vertical edge of the shortened size just created. A size of 10 mm should be sufficient to provide

enough area for the joint to be soldered. Repeat these steps to create the other sides and tabs.

To provide more strength to the box and protect the user from sharp edges, the top edges are folded over. The 180° fold will need to be done in two steps, a short 2 mm flange followed by a longer 10 mm flange. When folding the second side of the

box, you will need to use the symmetrical offset option to give clearance for the first edge.

The last step is to use the Modify->Create Flat Pattern to create an unfolded version with the fold lines marked on them.

// To provide more strength to the box and protect the user from sharp edges, the top edges are folded over //

From the flat pattern you can then make a drawing and either print out full-size or add dimensions to use when marking out the metal. The 'linear dimension' works well for this as it allows you

to measure between lines that are not joined up. Change the precision of the dimensions to round to the nearest mm.

The lid of the box is formed in the same way as the box. When designing this, scale the sketch so that the list is just bigger than the box. Use the measure option on the box to check the folded

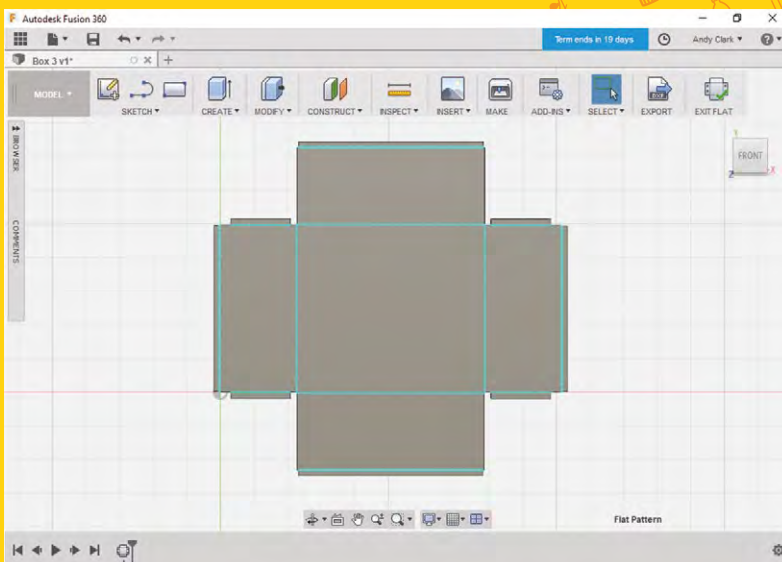

Left ▾
The complete pattern ready to be transposed onto metal

FOLDING MACHINES

There are a variety of machines to help you form folds in sheet metal. The simplest is a press brake, a V-shaped anvil with a solid 'knife' to press the metal into the V. These can be used in a press or vice.

Large versions of the press brake use levers or hydraulics to push down the knife.

A pan folder uses a hinged bar to raise up the edge in a similar manner to how we did the job manually.

QUICK TIP

You can also use cardboard to prototype your box if you are not so familiar with CAD.

DIFFERENT TYPES OF GAS TORCH

Simple gas torches consist of a brass nozzle and regulator that screw into a fitting on the top of a disposable canister. Bigger torches have pipes so they can be used with large, and hence less portable, canisters. The canisters contain liquefied gas which boils as soon as it is released into the air. Some torches have a sparker built in to light the gas, it's also possible to purchase a flint cup sparker to light the gas.

The regulators and nozzles are designed to work with specific gases so if you want to use more than one gas you'll need to get the right burners.

Gas should be stored somewhere that is well ventilated but also protected from the weather. For larger bottles, a cage with a roof is typically recommended.

There are several gases that are available in DIY stores:

Butane gas is the same gas you find in lighters. It's cheap and readily available. It has the lowest boiling point of all of the options and hence, when working in cold weather, this gas may refuse to leave its container.

Propane is the next up the scale and is typically found in larger burners such as the type for melting roofing felt or killing weeds. The canisters for propane are typically larger and, combined with a bigger burner, can provide more heat. We found this was the best option for the size of box being made.

Butane propane mix is cheaper than propane and is a combination of both the above. It shares the properties with both, providing more heat than pure butane but is available in smaller canisters.

It's worth briefly mentioning oxyacetylene, it is possible to silver solder with this but you are more likely to melt your metal. Oxyacetylene is great for welding but might be tricky to adjust down to a good temperature for silver soldering.

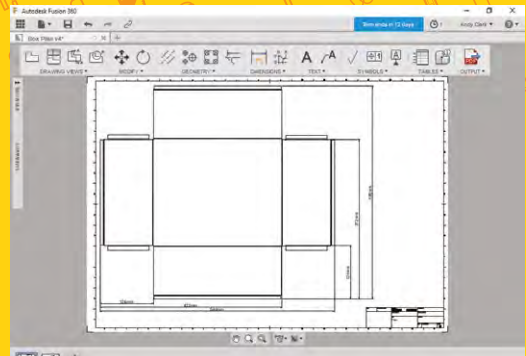

Above Create dimensioned drawings to aid marking out

size as this will be slightly larger than your original sketched rectangle. Allow 0.1 mm clearance so that the box does not wedge in place, and don't forget to allow for the tabs which are folded on the inside of the lid. Model the box and create another flat pattern. You'll now be able to determine how large a sheet of metal will be required. We picked a 1000 mm x 500 mm sheet and then adjusted the design to use the full width of the sheet, this saved quite a bit of sawing.

Below Avoid frustration by getting your tools ready before you start



SOURCING METAL

This kind of box design will work with a variety of metals. Mild steel is the cheapest but you'll need to apply paint to protect it from the elements, 0.5-0.7 mm is a good thickness for hand-folding. If you have a folding machine, then thicker 1 mm steel can be used and is slightly easier to source. Ensure you avoid zinc-coated steel as that is not appropriate for silver soldering. Stainless steel does not need paint but you will need to take care when working it as any scratches will need to be polished out afterwards. Aim for thinner stainless steel such as 0.3mm as it is stiffer and hence harder to fold. Silver soldering also works well with brass sheet which can be a good choice for smaller boxes as it is more expensive than steel.

For small metal orders the delivery charges can be as much as the cost of the material. Take advantage of your local hackspace by clubbing together on a larger order.

MEASURE TWICE, CUT ONCE

Before starting, check that your sheet is square. If not, mark off and cut the sheet so you've two sides that are square that you can measure from. One

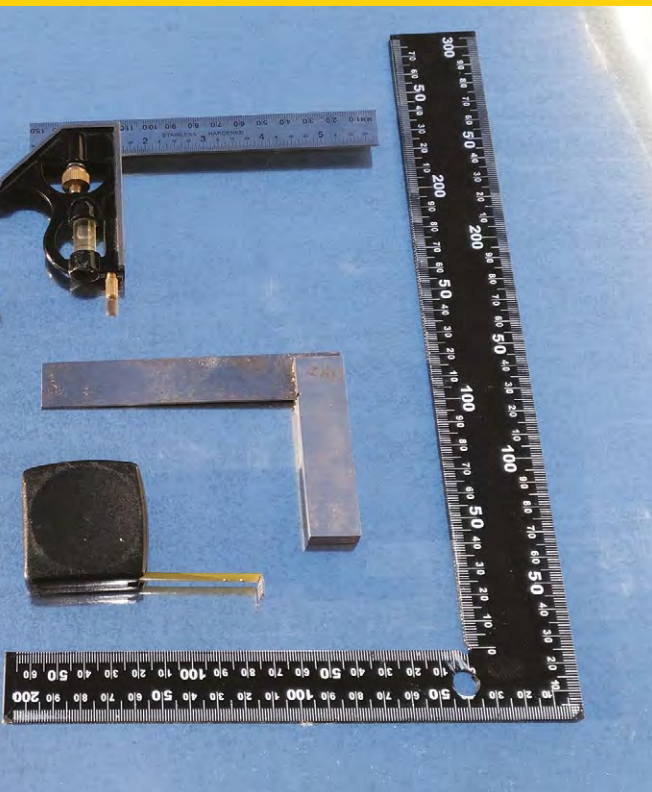

SAFETY

There are a few specific things to think about when working with sheet metal.

- Protect your eyes from sparks and metal fragments with some goggles.
- Protect your hands when handling the sharp edges of the sheet metal, leather gloves work well.
- Protect your feet from falling sheet metal and tools with sturdy steel toecap boots.
- Protect yourself and work area from the heat and flame of the gas torch by having a fireproof work area and keeping flammables out of the way.
- Protect your lungs from fumes by working in a well ventilated area.
- Avoid silver soldering zinc plated steel as the zinc will melt and form poisonous fumes.



of the best ways to mark out the pattern is a metal scribe. This has a hardened point so cuts a very thin line in the metal. It can be hard to see these lines, so use layout blue or a permanent marker to provide a background so that the scribed lines are more visible. You may find it helpful to mark the folding lines with a dotted line to distinguish them from the cutting lines. We also like to mark the pieces to remove with red so that we don't accidentally cut off an important tab.

CAN YOU CUT IT?

When cutting sheet metal, it is important to support the metal close to the cutting line. It is also helpful to clamp the work to the bench with several clamps. Make sure you have lots of space to move around the sheet so you are not restricted when cutting. For 0.5mm steel, a hacksaw will quickly →



QUICK TIP

When cutting sheet with a hacksaw, keep the blade at a shallow angle to the work.

Left ◊
Blue helps the scribe marks show clearly



Above ♦
Fold against the
wooden former

cut through, but for a thicker sheet you may want to use an angle grinder with a slitting disk. Saw on the waste side of your line to avoid cutting undersize. First cut out the big sections then return, perhaps with a smaller saw, to cut out any details. Once you've cut out the pattern, debur the edges with a file to remove any big snags. Then smooth the sharp edges with an emery cloth. It is also worth cleaning the metal at this point as it will be easier than when it is folded up. Remove any dirt and grease, paying attention to the edges that will be silver soldered.

FOLD ALONG THE DOTTED LINE

Thin sheet metal can be folded by hand but it will need some support. Start with the short tabs as those will be inaccessible later. Clamp blocks of

ALTERNATIVE ASSEMBLY

The tabbed approach to building this box could be easily adapted for a spot welder or pop rivets.

wood along the line of the fold, these are called formers. Don't try to form the complete fold in one go. Use a mallet or hammer with gentle taps and work along the tab folding a little each pass. Once the fold is nearly complete you may find it easier to remove the clamps and hold the former by hand. This allows you to fold just a little bit more than 90° to compensate for the springiness of the metal.

Repeat this process with each of the side folds. For the last side we had to carefully remove the clamps before we got to 90°, as they were obstructing the fold.

To form the top edges, first clamp and fold them to 90°, then you should be able to remove

// Silver solder has a **higher melting point** than electronics solder and is supplied in the form of thin rods //

the formers and fold them completely back on themselves. Ensure you fold each of these identically so that the corners line up.

Folding the box lid follows the same process as for the box body, first fold the tabs then fold up each of the sides. Do a test fit once you've folded two of the sides to ensure that the lid is large enough to fit but sufficiently snug to stay on by itself.

SILVER SOLDERING FOR STRENGTH

Once your box is folded you can silver solder the tabs to give it more strength. Silver solder has a higher melting point than electronics solder and is supplied in the form of thin rods.

To form a good joint, a flux is required. The flux comes in the form of a powder that is mixed up as required. This is toxic so avoid skin contact and do not eat or breath it in.

Ensure the surfaces to be joined are clean and free of grease. Mix up the flux powder with a small amount of water to form a paste that can be



Above ♦
Aim for a dull red or orange colour

applied to the surfaces. Paint it onto the parts to be bonded. Try not to get flux on parts that you don't want soldered. Clamp the parts together with some heat-proof clamps. We find welding clamps are good for this task. Position the box so the joint is flat, hot solder will flow downhill.

Heat the joint with a torch until it flows red. Keep the torch moving so that the surrounding areas are not heated too. You should see the flux melt and bubble. Once the joint is red hot, apply the solder along the edge of the joint, you should find it melts readily and flows into the joint.

Once the joint is formed then leave the work to cool naturally before removing the clamps or they will come undone. Repeat this for each of the

Below ♦
Choose a suitable size and shape of clamp

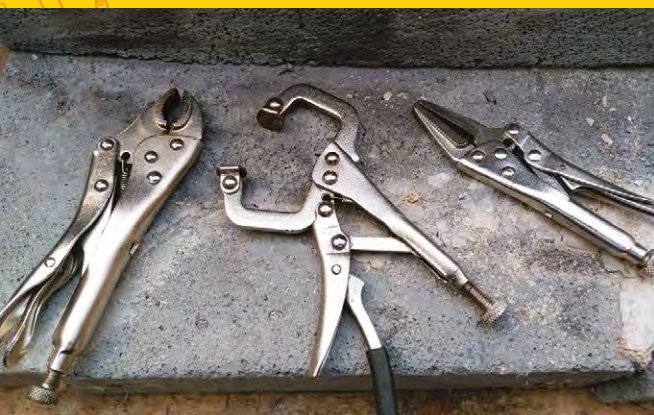

corners and for the tabs on the lid. If any of the joints are not bonded then wait till they are cool before cleaning and reflowing.

FINISHING TOUCHES

Once you've finished soldering and the box and lid have cooled, you'll need to clean off any flux residue. If this is excessive you can use an acid cleaner but we find you can remove it with wire wool or an emery cloth. Clean the box well and apply a metal primer before adding the top coats of paint. If spray-painting, lots of thin coats work best and always work with suitable ventilation.

The box handles we found were already zinc-plated so we did not want to solder those to the box. They also had some handy holes in each corner which are ideal for bolts or rivets. □

FURTHER READING

Sheet Metal Work (Workshop Practice Series #8) by R.E.Wakeford

Sheet Metal Work (Crowood Metalworking Guides) by Marcus Bowman

Soldering and Brazing (Workshop Practice Series #9) by Tubal Cain

QUICK TIP

When working with larger sheets, a framing square will be easier to use than a smaller engineer's square.

Below □
A sturdy metal storage box



Make a Dremel table saw

Upgrade your multi-tool to make perfect, straight, repeatable cuts



Alex Eames

RasPiTV

Alex Eames loves making things and regularly blogs/vlogs at RasPi.TV. He makes a living designing and selling RasPi.io products.

Accurately cutting small female pin headers, PCBs, threaded rods and suchlike with a hand-held Dremel can be difficult, hand-achingly tedious, and a bit uncontrolled.

Using just a piece of MDF, a small amount of wood, and some bolts, you can clamp down your multi-tool to keep it rock-steady. This is also brilliant for grinding and polishing small items.

Then add some 3mm acrylic (or thin MDF), threaded rods and nuts and you can go the whole hog, converting your multi-tool into a small table saw. Just add a fence for perfectly repeatable, straight cuts.

If you already have a multi-tool, you can convert it to a small table saw for about £8-worth of hardware, £8-worth of materials, and some workshop time.

Above

Your completed tool might not be quite as powerful as a full table saw, but it can make precision-cutting thin material easy

LET'S GET STARTED

You'll need to make two wooden clamps to hold your multi-tool down on the base. One should go close to the spinning end of the multi-tool, but clear of the collet/chuck. The other clamp should be a few cm further back along the tool at a convenient place to match your available drill sizes. If you have a Dremel flexible shaft adapter, the holes can be exactly 19mm ($\frac{3}{4}$ ") and 25mm (1").

Drill out the large central holes for the two clamps by clamping or taping the two wood pieces together and drilling through the centre. Your drill bit should

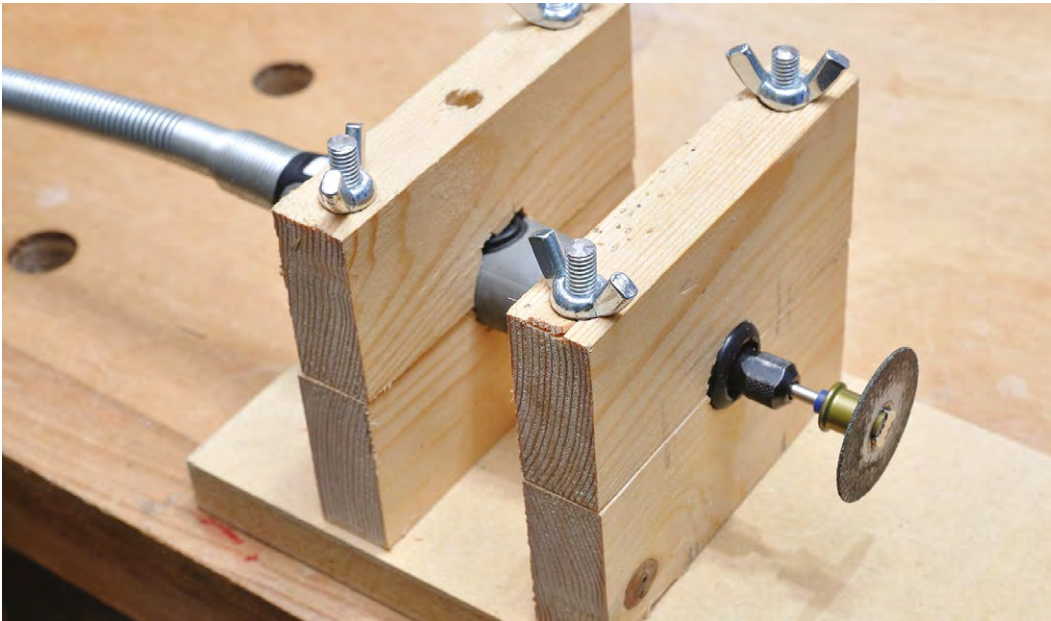

Left ♦ Ensure the wood securely holds your Dremel in place

YOU'LL NEED

- ♦ **MDF 40 × 11 × 1.2 cm**
- ♦ **4 × Wood 10 × 4.4 × 1.8 cm**
- ♦ **4 × M6 threaded rod 30 cm**
screwfix.com
- ♦ **20 × M6 nuts**
screwfix.com
- ♦ **6 × M6 wingnuts**
screwfix.com
- ♦ **1 × M6 washer**
screwfix.com
- ♦ **2 × A4 sheet of 3 mm acrylic or thin MDF**
hobarts.com
kitronik.co.uk
- ♦ **Dremel or multi-tool** (ideally with a flexible 'snake' adapter)
- ♦ **Drill + 6 mm (¼"), 9.5 mm (⅜"), 19 mm (¾"), 25 mm (1") drill bits**
- ♦ **10 mm spanner, adjustable spanner, saw, glue gun, hacksaw, file, clamps** and general workshop tools
- ♦ **Router with ¼" cutter or laser cutter** (for cutting slots in acrylic fence)

Left ♦ Securely clamp your wood before drilling to ensure clean holes

be aligned so the cut spans both pieces of wood perfectly symmetrically, with the centre point of the drill right in the middle.

YOU KNOW THE DRILL

You're going to use lengths of M6 threaded rod to hold the clamps to the base and retain the Dremel securely, so we need to drill holes for this. With the two wood pieces correctly aligned and clamped or taped together, drill 6 mm holes (~1 cm from each end) right through both pieces. Do this for both clamps. If you have a long enough drill bit, you can do this in one operation. Otherwise drill as far as the bit will allow, then remove the top part, then carry on through the bottom part.

Next, place the bottom half of the first (outer) clamp on the base about 4 cm from the left-hand end. Trial-fit the Dremel and use it to place the bottom half of the other clamp correctly. Once satisfied, use a few blobs of hot glue to hold the bottom halves to the base temporarily. Drill four 6 mm holes through the MDF base, using the bottom halves of the wooden clamps as a guide.

Gently remove the clamps, flip the base over, and counter-bore the four holes you just made using a 9.5 mm (⅜") diameter bit to a depth of 5–6 mm. If you have a ⅜" Forstner bit, these make a lovely flat-bottomed hole. If not, a normal drill bit will do. These four recesses will each hold an M6 nut.

CAPTIVATING NUTS

The 9.5 mm hole is deliberately a bit too small for the nut. This lets us make it a 'captive nut' so it won't try to rotate when in use. **Here's how to insert it in the MDF base...** →

PROJECT FILES

The DXF and SVG design files for the acrylic (or MDF) table parts can be found at hsmag.cc/cfOfsq. They are eminently tweakable to suit your own needs. If you're using a different multi-tool or have no flexible adapter, you might want to adjust the table cut-out to better fit your tool.

See below for the default version: a layout of the table and fence SVGs...

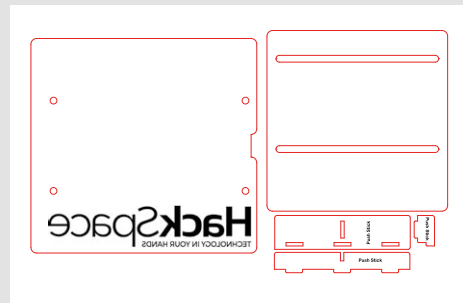

TUTORIAL

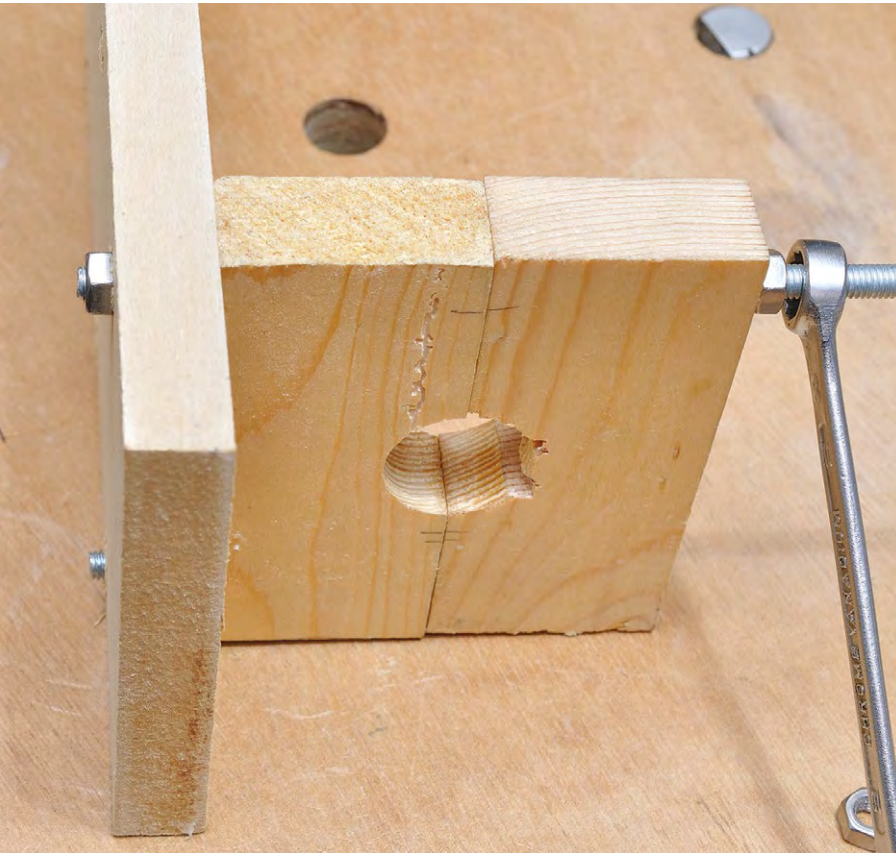

Above ♦ You can use this style of clamp to hold all sorts of round objects securely in place

QUICK TIP

To mark your clamp block for carving, use a felt-tipped pen on protruding parts of the Dremel, then press the blocks together, thus marking them.

Shorten the threaded rods so that they stick up proud of the clamps by only ~15 mm.

Once cut, you may need to dress the ends of the threaded rod with a file. Then use M6 wingnuts to secure the clamps conveniently.

- Take one of the M6 threaded rods
- Thread an M6 nut onto the end so it's completely on the rod
- Push the other end through the underside of the base
- Add the two halves of the wooden clamp (this aids alignment)
- Place an M6 washer over the rod and on top of the wooden clamp
- Thread an M6 nut all the way down to the washer
- Tighten the top nut with a 10 mm (or adjustable) spanner until the nut at the bottom of the base has been pulled completely into the base
- Make sure that neither the bottom nut nor the threaded rod end are protruding from the base (or your work surface will be scratched)
- Repeat for each of the remaining three clamp holes

Now trial-fit your Dremel or extension. If necessary, you can make any adjustments to the clamping blocks by carving out excess material for a perfect fit. If it's loose, or isn't secure, don't continue until it's fixed. If the tool comes out when running it could be dangerous, so make sure this isn't going to happen.

Once you have the main table top part, place it on the base, lining up the cut-out on the left-hand side with the Dremel. It should be touching the wooden clamp, but not overlapping the Dremel. Mark the locations of the four holes and disassemble the clamps ready for another round of drilling and counter-boring.

Drill four 6 mm holes through the base in the marked places. Then counter-bore to 5–6 mm depth with the 9.5 mm drill and embed an M6 nut in each of the counter-bores using the same method as before.

If you're following the plan exactly, you will need four M6 threaded rods 8.5 cm long for the table supports. If you're changing the design, the length will change accordingly.

MULTI-THREADING TIME

Thread an M6 rod into each of the four table support holes and add an M6 nut to 'lock' the rod in place. Don't fully tighten it yet. Repeat for all four table supports. Thread a further two M6 nuts onto each rod. The top of the uppermost nut should be 50 mm from the base. Tighten the two nuts together to lock them in position. This sets the table height 50 mm above the base.

Below ♦ The 'table' for our mini table saw is held in place with M6 thread and nuts

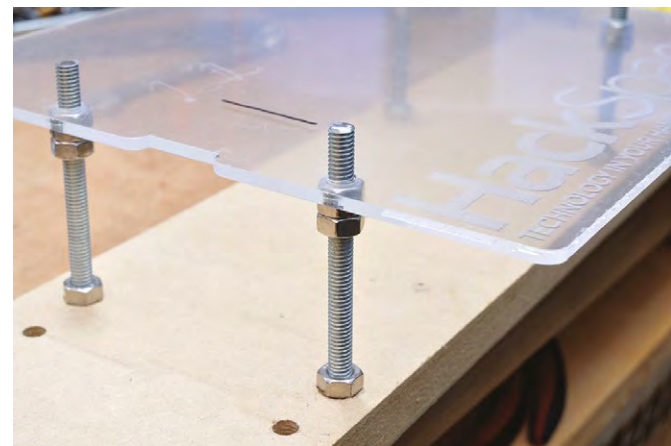

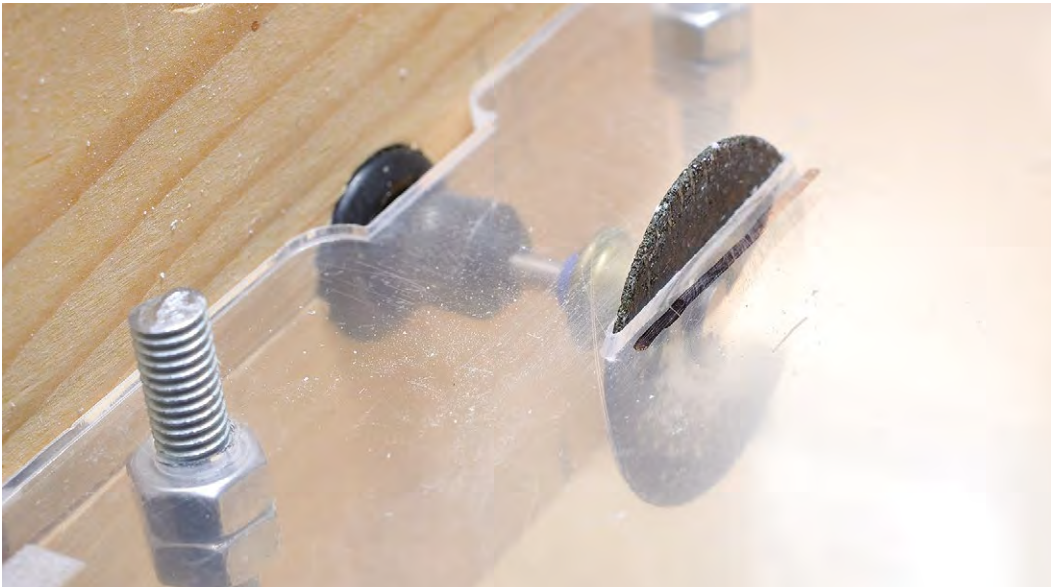
**QUICK TIP**

If one of the threaded rods gets in the way when you're cutting, shorten it, remove it or lower it down through the base.

Left ◆ The encased blade is held securely for more accurate cuts

Check that the table top fits over and lines up correctly with the threaded rods. If needed, you can push and 'persuade' the threaded rods slightly into place to correct small alignment errors. Once positioned correctly, tighten the bottom lock nuts at the base, ensuring the rods are not sticking out underneath.

Remove the table top, reinstall the Dremel clamps and Dremel, with cutting disc fitted.

Now place the table top back on the supports but not in contact with the cutting disc. Switch on the Dremel to a medium speed. Now use the cutting disc to cut its own 'zero clearance' slot in the table top by gently pushing the table top down onto the supports. It may be necessary to stop part-way through and clear out any accumulated debris. Repeat this process until you have cut a slot for the disc. Avoid contact with any other part of the Dremel other than the disc. Set the table height by adjusting the top two nuts on each support as required.

NOT LASER-CUTTING?

3mm acrylic laser cuts beautifully, but can also be worked very nicely with woodwork tools if you prefer. The table top could just as easily be made out of MDF, but it must be fairly thin or you won't get much cut depth with your 38mm diameter Dremel discs.

If you're not laser-cutting the table parts, print out the files and use them as a template for drilling and cutting.

If you're not laser-cutting the fence part, you'll need to rout the two slots carefully (using a fence, guide or router table) with a 6mm or ¼" bit. It's advisable to do this in two passes. If you try to cut full depth in one pass, breakages can occur. (Been there, done that!)

// If you're following the plan exactly, you will need four M6 threaded rods 8.5 cm long for the table supports. **If you're changing the design, the length will change accordingly** **//**

Peel off any protective film from the acrylic and enjoy the glorious look of your shiny new table surface.

In use, you should set the final table height so that enough of the disc is protruding for you to make your cut.

ADD A FENCE

Next attach the fence using the two right-hand table support posts and two M6 wingnuts. The fence position can be adjusted according to your required cut length.

If you want to use a push stick to protect your fingers, there's a 3-piece 'slot-and-glue' design in the project files: hsmag.cc/cfOFsq. Enjoy the Dremel table saw and may your cuts be ever straight and true. □

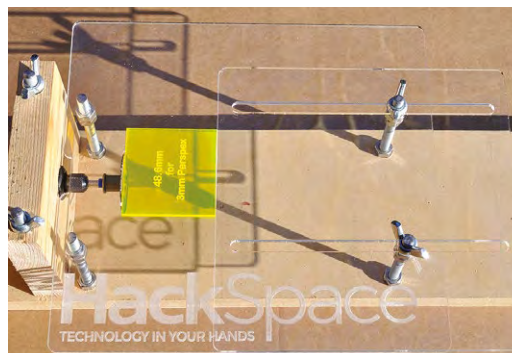

Left ◆ You need never have wonky cuts again with your encased Dremel table saw

Laser-cut a 360° GIF turntable

Create stunning 360° animated GIFs easily with this geared turntable



Alex Eames

RasPiTV

Alex Eames loves making things and regularly blogs/vlogs at RasPi.TV. He makes a living designing and selling RasPi.O products.

A 360° animated GIF (or video) is an excellent way to showcase your latest make or product. It will help you to provide a professional-looking all-round view. You can make your own with free software and around £10 worth of materials.

The mechanism in this plan suits turntables up to 40cm in diameter, but you could quite easily scale it to make whatever size you want. Angular resolution could be further increased by adding a third reduction stage.

To make a nice 360° animated GIF you need a minimum of 16 frames, but 32 is better. More frames results in a bigger GIF file, but a more realistic, less jumpy animation. To be able to make $\frac{1}{16}$ th of a rotation in an accurate, controllable, repeatable way, you'll use gears so that one turn of the crank handle gives $\frac{1}{16}$ th

turn on the turntable. (You can do $\frac{1}{32}$ nds with half-turns of the crank.)

Designing gears is fairly simple with software. The good news is that you don't need to know any mechanical engineering theory to do it.

Inkscape is a free and open-source vector graphics package offering masses of features and is available on Linux, Windows, and macOS. It also works on the Raspberry Pi and is widely used by people preparing SVG files for laser cutting. Even better, it has a built-in extension for designing gears. If you haven't got Inkscape yet, you can find it at inkscape.org.

Below

Fully assembled 360° GIF turntable, ready for use. View the animated GIF output from this photo session at: hsmag.cc/OzMEEJ

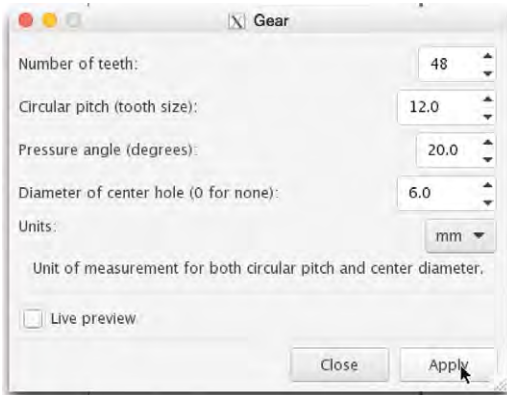

**Above** ♦

Designing gears in Inkscape is as simple as selecting four parameters and choosing your units of measurement

To access the Inkscape gear designer, from the menu, choose...

Extensions > Render > Gear > Gear

Four design parameters determine the gear's characteristics:

- Number of teeth
- Circular pitch
- Pressure angle
- Diameter of centre hole

Below ▣

Gears all assembled on their three axles. Note the handle on axle 1 and protrusion to hold turntable on axle 3

The number of teeth and tooth size (circular pitch) determine the overall size of the gear. You can work in pixels, mm, or inches. This project uses mm.

PROJECT CONSTRAINTS

12 mm circular pitch gives a suitable tooth size for 6 mm ply, which our gears are made of. At this pitch size, a bit of experimentation shows that the minimum number of teeth for a gear to mesh satisfactorily with a much larger gear is 12 (6, 8, and 10 were all tried and found unsatisfactory.) The largest gear, at this pitch size, that fits comfortably on an A4 sheet of 6 mm ply has 48 teeth.

The aim is to create an overall gearing of 1:16, so that one turn of the handle gives $\frac{1}{16}$ th of a rotation of the turntable. You will achieve this in two stages of 12:48 (1:4), using two 12-toothed gears and two 48-toothed gears.

Four turns of the 12-toothed gear on axle 1 rotates the 48-toothed gear on axle 2 once. Axle 2 also has its own 12-toothed gear. Four turns of this rotates the 48-toothed gear on axle 3 once. The turntable sits on spacers above this final gear, and rotates once for every 16 turns of the crank handle.

GEAR UP

Either download the SVG from hsmag.cc/Xcwhir, or create your gears in Inkscape using the following parameters. You'll need two of each gear and one bar for the crank handle. →

YOU'LL NEED

- ♦ 2 × A4 sheet
- ♦ 6 mm birch laser ply
- ♦ 500 × 70 × 18 mm length of wood
- ♦ A4 sheet of 9 mm birch ply
- ♦ A4 sheet of white sticky-back plastic
- ♦ 30 cm M6 threaded rod
- ♦ 20 M6 nuts

TOOLS

- ♦ **Clamp** (to hold turntable to a surface while in use)
- ♦ **Drill and 6 mm bit**
- ♦ **Access to laser cutter** (can cut gears manually, but laser is much preferred)
- ♦ **10 mm spanner and adjustable spanner**

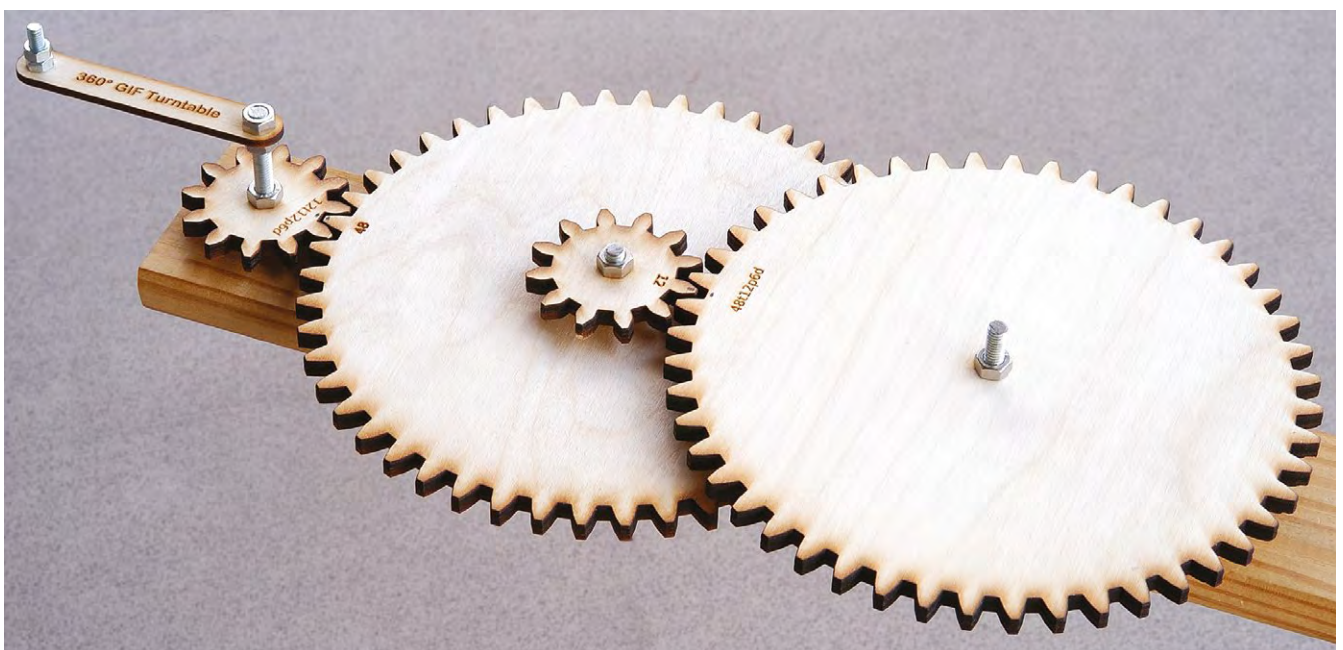

QUICK TIP

When designing gears, it can be useful to mark the parameters on each gear e.g. for 48 teeth, 12 mm pitch, 6 mm diameter: 48t12p6d

PROJECT FILES

The project files are all in the GitHub repository at hsmag.cc/Xcwhir, as are some output example GIFs made using this turntable.

If you don't want to design your own gears, grab the editable SVG file [GIF-turtable-12-48.svg](#) from there. You'll need two of each gear and one handlebar. It is possible to cut gears by hand, but it's very labour-intensive and intricate. You'd need a band-saw, scroll-saw, or coping saw and it would take a long time. Laser cutting is greatly preferred if available.



Above Boost turntable height and keep it flat and level with four plywood spacers

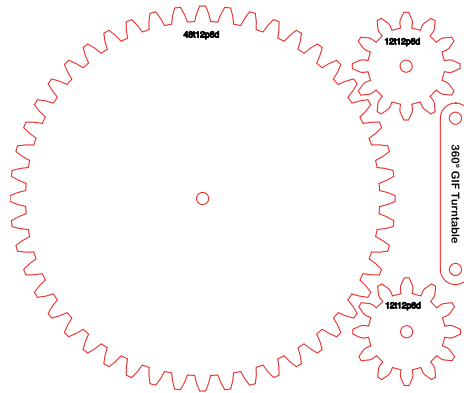

Right You'll need two of each gear size and one handlebar

48 teeth, circular pitch 12.0, pressure angle 20.0, diameter of centre hole 6.0, units mm.

12 teeth, circular pitch 12.0, pressure angle 20.0, diameter of centre hole 6.0, units mm.

For the base, take a piece of wood approximately 50 × 7 × 1.8 cm and drill three 6 mm holes, starting at 3 cm from one end and with 11.6 cm between centres. Make these as perfectly perpendicular as possible. These will position our three M6 threaded rod axles so that the gears mesh nicely.

Each of the axles protrudes through the bottom of the base by ~11 mm, which is long enough to attach two M6 nuts.

Axle 1 (~7.2 cm long) bears one 12-toothed gear and the crank handle bar. The gear is held in place with two M6 nuts, as is the bar. Using M6 nuts, loosely attach a small length of threaded rod to the outer hole on the handle bar so it rotates freely.

Axle 2 (~5.6 cm long) bears a 48-toothed gear, held in place between two M6 nuts, and a 12-toothed gear above it, held by another M6 nut. The nuts need to be tight enough to prevent the gears spinning freely on the axle. They also act as spacers to minimise friction.

Axle 3 (~6.4 cm long) bears a single 48-toothed gear, resting on three M6 nuts, raising it to the correct height to mesh with the 12-toothed gear on axle 2. This axle protrudes approximately 17 mm above the gear so that the turntable can be fitted to it.

Assemble all three axles and attach them to the base. Check that all the gears are meshing nicely and adjust axle tension as necessary (using the bottom two nuts).

Using a compass, mark and cut a 20 cm diameter circle from 9 mm ply and drill a 6 mm hole in the centre. Cut four 6 × 4 cm pieces of 9 mm ply to act as spacers for the turntable. Cover the circle with white sticky plastic film. This will give a nice clean, white background for your photographs.

Below Side view showing vertical orientation of the gears. The large gear on axle 3 rests on three M6 nuts



Place the four plywood spacers on top of the 48-toothed gear on axle 3, and place the turntable on top of those. You don't need to fix the spacers in place, but you can if you want to.

GET SNAPPING

Clamp the free end of the base to a table top or workbench. Place your item(s) on the turntable. Set up your camera, tripod, and lighting. Take a photo and turn the crank handle exactly one turn. Repeat this until you have 16 photos. (If you want 32, you can use half-turns.)

GIF ME A BREAK

Once you have your 16 (or 32) photos, you can convert them into an animated GIF using a free tool at: hsmag.cc/WlMAVY.



Above  A tripod or magic arm is essential to keep the camera position constant. A remote shutter-release really helps too. Note the turntable base firmly clamped to the bench

GET IN GEAR

Circular pitch determines tooth size. It's defined as 'the arc distance between the centres of two adjacent teeth'.

Pressure angle is defined as 'the angle between the line of force and a line at right angles to the centre line of two gears at the pitch point'. It's a key parameter of gear design, but 20° is fairly standard, so we'll stick to that. The software allows you to vary the value between 10° and 30° if you want to see what difference it makes. You don't need to know anything much about it except that it's important that all gears that you want to mesh together have the same pressure angle and circular pitch.

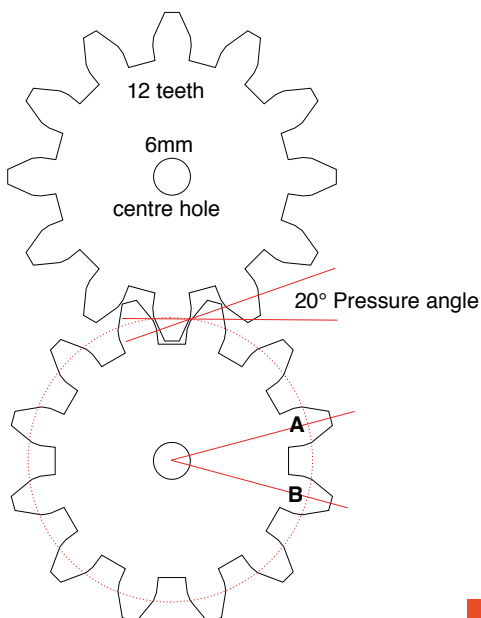

- Upload your images
- Check that they're in the correct order. You can drag and drop them into place if you need to move any
- Set your canvas size (in % or pixels)
- Drag the slider to set your animation delay speed (milliseconds between frames)
- Set your number of repeating loops (0 = infinite)
- Click the 'Create GIF animation' button

After a short while, below the 'Create GIF animation' button you'll see links to 'View the GIF' and 'Download the GIF'.

There's no preview or prediction of the file size, so you'll need to download the GIF file to check how large it is. You can tweak the parameters to get the target file size and rotation speed you want. For Twitter, your GIF needs to be under 5MB. Generally ~200 milliseconds works well for animation speed.

In the 'blue tin' example, hsmag.cc/yddMXd, 32 frames at full resolution of 1001 × 795 pixels gave a 7.9MB file. To get this below 5MB, it had to be scaled to 60% (600 × 477 px), which gave 4.8MB.

EXTRA CREDIT

This project is fairly easily scalable and tweakable. If you want a larger turntable or better angular resolution, you could use a longer base and add a fourth axle with an extra gear set on it. It could also be motorised and/or combined with a camera remote to fully automate the process. You could control that with an Arduino, ESP8266, or Raspberry Pi. But, however you decide to build it, have fun, and take some great GIFs. 

QUICK TIP

The bottom two nuts on each axle are 'locked together', but the axle should be able to spin without too much resistance. It's a trade-off between 'too tight' and 'wobbly'.

Left  Two intermeshed 12-toothed gears showing pressure angle and circular pitch

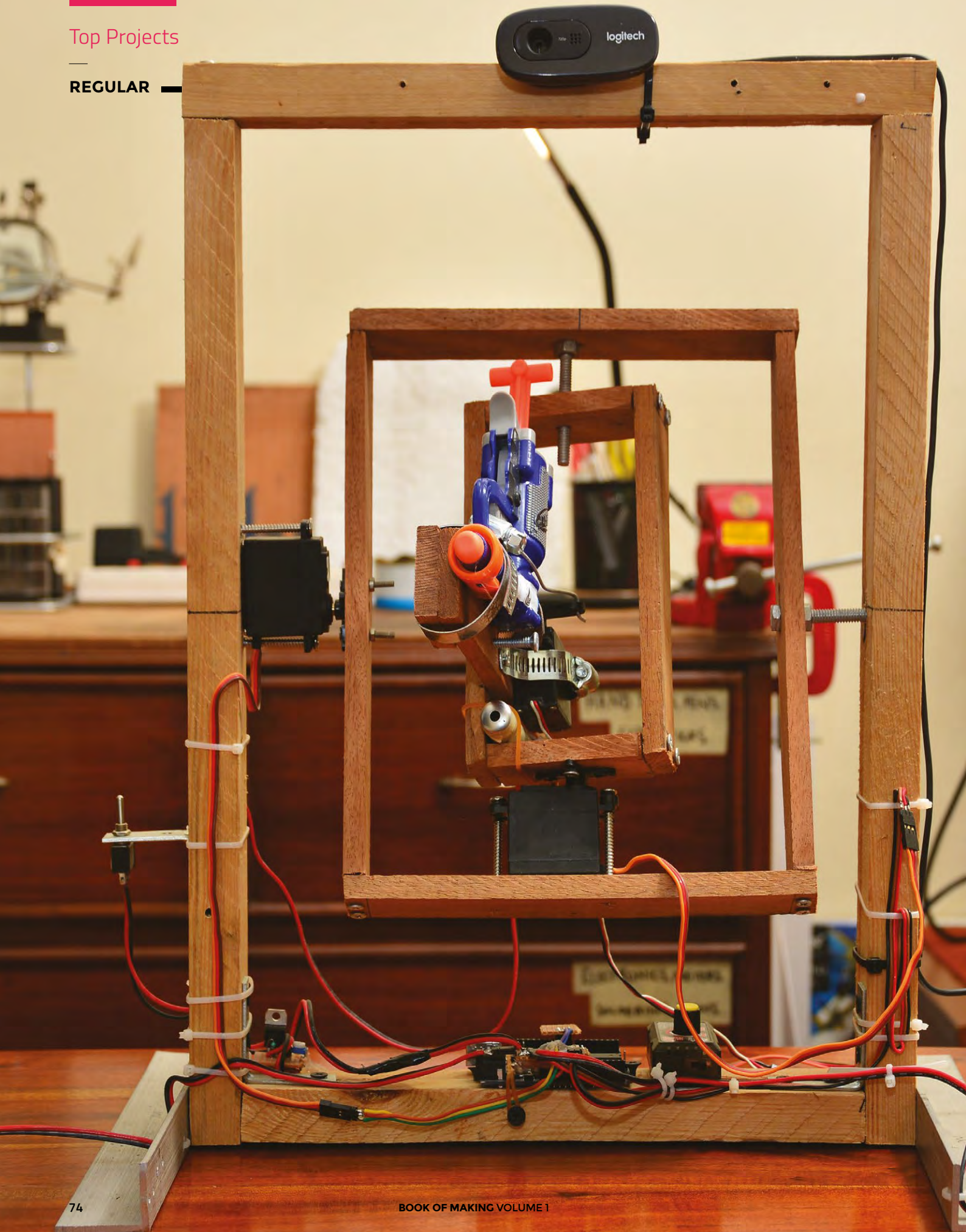

Robot that shoots you in the face

By Mihir Vardhan

Makingwithmihir.com

Simply put, this is an intricately designed, far-from-practical, over-the-top robot that shoots you in the face. It uses a dirt-cheap Logitech webcam, three servo motors, an Arduino, a Nerf gun, and some code from hsmag.cc/SRjafW to track your face and shoot it.

The robot has X-axis and Y-axis modules, mounted on a simple wooden frame, that support and move the shooting mechanism – a toy Nerf gun. Each axis and the trigger of the Nerf gun is controlled by high-torque Futaba servos. A webcam mounted at the top of the wooden frame is used to locate your face.

The servos controlling the axes and the trigger are controlled by an Arduino that is programmed to use processing code running on my laptop. This processing code is the brain of the computer vision functionality of the robot. The original code aimed a paintball gun at the chest of a person but, with a few quick modifications, I managed to get it to aim at my face reliably.

This processing code spits out coordinates that are sent to the Arduino, which controls all three servos to correctly position and shoot the gun. The servos have a heavy current draw and need an external 5V power supply. For testing purposes, I added an external switch with a servo controller to fire the gun.

Now, considering that I have essentially built an automated turret, I just had to add a green laser as a sight to satisfy the stereotypes of every futuristic weapon ever, thanks to sci-fi movies. The laser needs 3V, sourced from the power supply using an LM317-based voltage regulator.

I believe in building over buying and reusing as much as possible, and so I kept the build as inexpensive as I could. The wood is all recycled pallet wood from a florist and the metal parts are scrap aluminium from e-waste. I used a modified ATX power supply to power it all with stable DC 5V. The electronics were the only part of the build that I did not manage to find a recycled source for. □

Left

Mihir's on a mission to show that making can be cheap and fun

WEEKEND PROJECTS

HACK | MAKE | BUILD | CREATE

Got a whole weekend spare to do some making? Then get stuck into these more advanced projects



PG
78

BUILD A DRONE

The ultimate guide to making
your own quadcopter



PG
104

BEAUTIFUL, UNIQUE KNIFE HANDLE

Craft a super-sleek knife
handle with deer antler

Top Projects –Showcase

Rapid Whale Mini Boat

PG
102



PG
92

A.I. ROBOT SENTRY

Create a smart sprinkler to
guard your garden

PG
98

HALF ADDER

Make things add up with this
electronic circuit

PG
108

BUILD A TREBUCHET

Storm the castle with this
miniature siege engine





BUILD A DRONE

Whether you call them quadcopters, drones, or multirotors, these aircraft are everywhere. Here's how to build your own



Jenny List

[@Jenny_Alto](#)

Jenny is the creator of the [@LanguageSpy](#) electronics kit and a key member of Oxford Hackspace.

T

here was a time when remote-controlled aeroplanes were expensive and difficult to fly, and remote-controlled helicopters were unaffordable and near impossible to fly. Those of us with dreams of flying our own machines

were left to look on from the sidelines, unable to participate.

We have been fortunate then, over the last couple of decades, to witness a technological revolution in manufacturing that has brought flight to within the reach of almost anyone. Powerful yet lightweight electric motors, coupled with batteries that have undreamed-of capacities, on machines made from advanced materials by precision mass production techniques, have given us aircraft for pocket money prices. Not only has this been a revolution in terms of cost, it has also given us entirely new craft that would have been impossible to fly before the advent of the computing power required to keep them in the air. A multirotor, commonly referred to as a drone, would have been impossible to fly by any other means than with the help of a computer to keep it in trim, yet now, due to their very low moving parts count, they are the cheapest and most commonly seen form of remote-controlled flight. Multirotors have become a part of hackspace culture in a way that other craft have not, so let's take an in-depth look at them and understand how they are built.

BUILDING BLOCKS

A multirotor has a central fuselage, around which are positioned a set of motors with fixed propellers, or rotors, whose thrust points downwards. A computerised controller monitors a gyroscope and accelerometer, and constantly adjusts the thrust from each motor to maintain the craft in level flight. The vast majority of multirotors have an even number of rotors, so you will commonly see quadcopters with four rotors, hexacopters with six, and octocopters with eight.

There are many different types of multirotor, each of which has its own characteristics and

applications. A racing quadcopter with extreme manoeuvrability, for example, will be completely different to an octocopter used by a broadcaster to carry a TV camera that requires stability and long flight time. It's time to look at just a few of the types you will commonly find.

SMALL BEGINNINGS

If there is a bottom of the heap in terms of multirotors, it's probably to be found in your local toy store. Toy micro-quadcopters have been on every child's Christmas list for a few years now and, while they may be cheap, they are no less fun to fly than their larger counterparts. About ten pounds will snag you the most basic, a tiny quadcopter that will sit in the palm of your hand and has about five minutes' flight time from a small lithium polymer battery.

MULTIROTORS HAVE BECOME A PART OF HACKSPACE CULTURE IN A WAY THAT OTHER CRAFT HAVE NOT

These machines invariably have little brushed DC motors and very limited outdoor capability, but their flight characteristics are such that, if you can master one, you should find flying a more capable machine to be no problem.

As the budget increases in the field of ready-to-fly multirotors, so do the capabilities of the models in question. The more expensive toy machines now have on-board first-person-view video transmitters and, as the price increases, there is a transition from the world of toys to that of serious machines. The motors have become brushless, the batteries much larger, they are likely to have GPS units and much better quality FPV video cameras, and accessories such as a camera on a gimbal can be slung underneath. The sky is the limit when it comes to high-end multirotor hardware.

This article however is about building a multirotor, and in it we shall look at all aspects of a simple build using off-the-shelf parts. We'll produce a machine that is a serious aircraft, that's fun to fly and expandable in different ways as you increase your multirotor flying experience. →

IT'S ALL IN THE FRAME

Choosing your
multirotor
style

Right ♦
The constituent parts
of our 450mm frame





nce a choice has been made over the number of rotors, there are a number of styles, depending upon the desired characteristics of the final craft. Which style you opt for

will have an impact across many

of the components that you will need to source for your build, but the most fundamental of those components is the one most closely associated with your style. The frame provides a platform to support the motors, batteries, and electronics, and must be rigid enough to permit the aircraft to fly without vibration or distortion.

We will look at two styles here: a 450 mm frame which will form the basis of the machine we'll be building, and a smaller frame designed for racing. If you need an analogy to help understand their different characteristics, in this context the 450 mm frame is like a large estate car, while the racing frame is like a racing motorbike. The former is a capable all-rounder that can carry anything a family can throw at it, while the latter is a fast and nimble machine designed for fun and thrills, but lacking significant carrying capacity. Multirotor styles seem to follow fashion – for instance, a few years ago the larger frame was king, while it's fair to say that the racing frame is a far more popular choice today. Yet we're building a 450 mm craft today, so why is this? The answer comes on several levels. The larger machine is a much easier one to fly than its smaller sibling, and its enhanced carrying capacity means that it is a far more versatile platform for future expansions and upgrades.

START IN THE MIDDLE

At the centre of a multirotor frame is always a platform for the electronics and battery, from which radiate the arms that carry the motors. We're looking at a quadcopter here, so in our case there are four arms. The electronics platform is frequently made into an enclosure in the space between two plates, this provides extra rigidity, as well as protection for the fragile components. A very popular choice for racing frames, due to its high strength and low weight, is a carbon fibre frame.

When choosing a frame, you will find a bewildering array of models to choose from in supplier catalogues and websites. Many of them are very similar, and among them will be many good choices but, as with so many things, there will be pitfalls to avoid. Fortunately the online

multirotor community has produced a huge array of information and component reviews, and you should always check the experiences of other builds with a component before committing your money to it.

The frame we are using for our build is a generic 450 mm frame, with glass reinforced plastic (GRP) arms, and a central platform made using GRP-printed

AT THE CENTRE OF A MULTIROTOR FRAME IS ALWAYS A PLATFORM FOR THE ELECTRONICS AND BATTERY, FROM WHICH RADIATE THE ARMS THAT CARRY THE MOTORS

circuit board material, that doubles as a power distribution system. Almost identical frames can be found from multiple suppliers. As is often the case with multirotor frames, there is a means of denoting which is the front of the craft – two of the arms are red in colour and we have assembled them in the forward position. →

OTHER KINDS OF DRONES

The first military drones were used in the Yom Kippur War (1973), as Israel flew unmanned aircraft to force Egypt to exhaust its supply of anti-aircraft missiles, ahead of manned missions. Since then, militaries around the world have been extensively using drones for reconnaissance and launching attacks.

Multirotors are now used in a wide variety of industrial roles, including building inspection, firefighting, filming, agriculture. There have been several widely publicised attempts to deliver food by drone, but none have been released commercially... yet.



KEEPING IT IN THE AIR

Flight component choice



Below 
One motor and the end of its arm



nce you have chosen your frame, the choice of all flight components – propellers, motors, motor controllers, and battery – stem from the frame’s characteristics. The size of the

frame dictates the size of the

propeller you will use, which in turn dictates the size and characteristics of the motors that will drive them, and then the appropriate motor controller to drive that, and ultimately the size of the battery required to provide enough power to keep the craft in the air.

The first of those choices is relatively simple. There is only a certain amount of space for a propeller on a given multirotor frame without adjacent propellers getting too close to each other, so a certain size range will be a natural progression. For example, our 450mm frame has a recommended propeller size of 8–10 inches, so we have gone for 8-inch propellers.

There are two figures to look at when choosing a propeller. One is the size, which we have already discussed, while the other is its pitch, or the angle of its blades. This is quoted as the number of inches that represents a theoretical distance it will travel for a single rotation. Going into the full detail of the mechanics of propeller design is beyond the scope of this article, however we are fortunate in that there is usually a recommended pitch range for a given propeller and frame size.

SPIN ME RIGHT ROUND

Propellers are normally sold in packs of two, containing both a clockwise and anti-clockwise component, and are quoted as a four-figure number, denoting their size and pitch. Our 8-inch propellers have a pitch of 4.5, and thus are 8045 propellers. If you are not a propeller guru, and we certainly aren’t, look online at similar builds to the one you are embarking upon, and base your choices upon theirs.

The propeller will sit upon a motor, in almost all cases except small toy machines, a brushless motor. These are motors that accept their electricity as three-phase AC over three wires, and require an electronic motor controller for operation. There are three figures that matter with a brushless motor, a figure that represents its dimensions, one that represents its speed, and the voltages and current it is designed for.

The dimensions of the type of motor you will use on a multirotor are expressed as a four-figure number that simply expresses its width and height in mm. So, our motors have a figure of 2212, they are 22mm wide and 12mm high. Your frame will

have the mounting points ready-drilled for the range of motors you are likely to use with it, and will have an acceptable physical size range as part of its specification.

Motor speed is expressed as a kV value, which denotes the rpm speed increase they deliver per volt. The kV should be matched to the propeller size, for example, our craft with its relatively large 8" propellers has 1000kV motors, while a racing frame with much smaller propellers might have a kV value of well over 2000.

WITH GREAT POWER COMES MOTION

Finally, the voltage and current figures of the motor define what motor controller and battery choices you should make. The voltage is often expressed in terms of battery pack size, as well as voltage, for example our motors are expressed as 2S-4S, meaning a lithium polymer battery with between two and four cells in series. There should also be a peak current figure that will be necessary when picking a speed controller.

The motor controller will be a small PCB with three sets of connections. There will be the three motor terminals, either large solder pads or wires, two battery input wires, and a control cable terminated in a plug designed for the PWM output of a flight controller, or radio control receiver. It contains a small microcontroller and the power transistors to control the motor. There are motor controllers that will run a motor in both directions, but those you are likely to encounter will be unidirectional. Since half your motors must rotate in the opposite direction to the others, you will need to wire them for reverse operation by reversing two of the three motor wires. The firmware used on the vast majority of motor controllers you will encounter is called BLHeli, and you will find controllers with either 8-bit or 32-bit processors. The important figures on a motor controller are the battery voltage, again expressed in terms of the number of cells, and the peak current it can handle. Both these figures should match their equivalents on your choice of motor.

All of your motors should be the same model, and all should be driven by the same model of controller. For this reason, both motors and controllers are often sold in packs of four. You will also see 4-in-1 controller boards that incorporate all four controllers, these are

PARTS LIST

Here are the parts we used, but this is just a guide. You'll need equivalents to the parts here, but there's no need to restrict yourself to these parts. There's a phenomenal range of choice in the parts you use and the best bit about making your own drone is that you can pick the add-ons that are best for you. Well, that and the fact that you'll know exactly how to fix it if (when?) you crash it and break something.

- 1 × 450mm PCB quadcopter frame kit
- 4 × Racerstar BR2212 1000kV 2-4S brushless motors
- 2 × 8045 carbon nylon propeller kits
- 4 × Racerstar Tattoo 30A 2-4S brushless motor controllers
- 1 × BF3.2 Omnibus F4 V2.1 ST 32 F4 flight controller
- 1 × XT60 male plug 12AWG 10cm with wire
- 1 × 1800mAh 75C 4S LiPo battery, with XT60 plug
- 1 × FlySky i6 FS-i6 RC transmitter
- 1 × FlySky FS-A8S RC receiver

- 2 × 220mm battery tie-down strap for RC drone
- 1 × 1m 12 AWG silicone wire SR Wire1
- 3 × screws
- 3 × stand-offs

We strongly recommend getting several sets of rotors as they're easy to break. Getting more than one battery will mean that you can keep flying while one is charging.

This is just for the basic drone. Once you've got experience flying it, you might decide that you want to augment it with more bits and bobs. A camera is probably the most popular extra feature, and they range from cheap, tiny sensors with low resolution, to professional-quality cameras. You will need to make sure that you've got a way of transmitting and receiving the camera feed. A gimbal will allow you to control the direction of the camera while the drone is flying, but it's hard to control both drone and camera at the same time. Make sure you get a second person to help control the craft.

MOTOR SPEED IS EXPRESSED AS A KV VALUE, WHICH DENOTES THE RPM SPEED INCREASE THEY DELIVER PER VOLT

designed for builds in which space and weight are at a premium, but have the disadvantage that, should you damage one of the controllers, you will have destroyed all four in a stroke. We bought a pack of four BLHeli 32-bit controllers, each with a rating of 2S-4S, and a peak current of 30 A. →

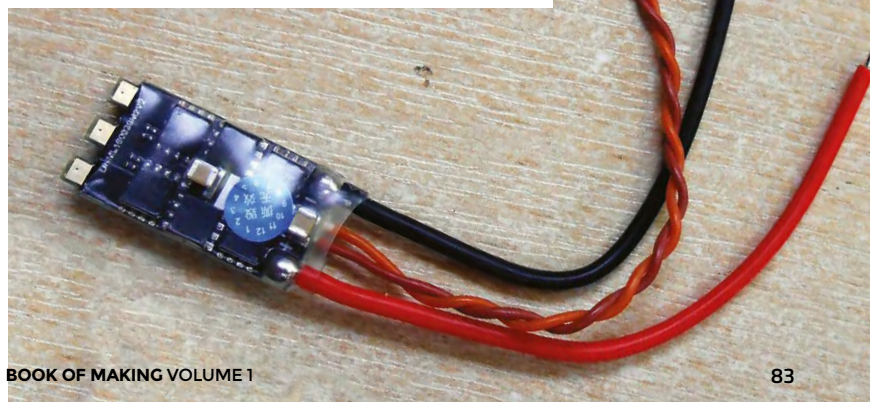

Below One of the motor controllers from our build

POWERING IT ALL

Choosing a battery

Left  Our flight controller, mounted upon part of our frame

P

robably the most confusing part of specifying components for a multirotor comes in choosing a battery.

On the face of it, this should be a straightforward component, but unlike, for example, an alkaline cell for a toy, there are a vast range of

different packs available.

All the batteries you should encounter for multirotors share the same chemistry: they are formed from lithium polymer cells, with a nominal voltage of 3.6V per cell. They are specified with figures as 'S' or 'P' by their configuration of cells in series or parallel, but in the context of multirotors we are only likely to encounter series packs. Thus, a 1S pack is a single cell, a 2S has two cells, a 3S three, and so on. 1S and 2S packs are in the realm of toys and small craft, so for our purposes we are most likely to find 3S and 4S packs. The higher the voltage, the less current required for a given power, so in our build we opted for a 4S pack.

The other figures on the battery are perhaps the most confusing. There is a capacity rating in mAh, and a mysterious 'C' rating. The former is simple enough, a theoretical measure of the quantity of energy it can deliver in terms of what current and for how long, while the latter gives a guide to the peak current it can deliver. Why they don't simply quote the peak current directly is something of a mystery, but the formula $peak\ current = C\ rating \times capacity$ delivers the answer.

The peak current must be able to cover the load from the whole machine, with all the motors consuming their full capacity. So with our quadrotor

having four motors of maximum 30A, our peak current needs to be at least 120A. Our build has a 4S pack with a capacity of 1800mAh, or for a more useful version of the same figure, 1.8Ah. Its C rating is 75, so the peak current is 75×1.8 , which is 135A. It certainly can't supply this figure for any length of time, but it provides a comfortable overhead beyond the capacity of our motors.

POWER UP

Lithium polymer cells are both powerful and compact, but that power comes at a price. They can be hazardous if not treated with care, as when they degrade they can build up hydrogen gas within them, and if punctured they can catch fire. They must always be stored somewhere fireproof and in a charged state, and never overcharged or aggressively discharged. You will find two connectors on a multi-cell lithium polymer pack: the main power connector, and a multi-way charge balancing connector, allowing the charger to monitor the voltage in each individual cell. Always use a proper lithium polymer charger with a receptacle for this balance connector, and it is imperative that you read the instructions and safety notes that come with your cells.

Having picked a battery pack, there is one other matter to attend to with respect to the power system on your machine. The battery connector will almost certainly be the popular 'XT60' design, and you'll have an XT60 plug and short lead to fit it. Something is required to safely pass the high current from it to the motor controllers, and that takes the form of a power distribution board. This is a printed circuit board with a master connection for the battery pack and a set of solder pads for each of the motor controllers. Sometimes a four-way motor controller doubles up as a power distribution board, and in our build it is incorporated in the frame, but if you don't have one, you will need to put one on your list of parts.

CONTROLLING IT ALL

The final large on-board component that we haven't covered is the flight controller. This is a small computer that monitors an accelerometer and gyroscope on a chip, and continually adjusts the power to the rotors to keep the craft stable, in the desired heading and altitude. Above all other components, this is the one that has made multirotor flight possible – maintaining stable multirotor flight unaided would have been beyond the abilities of human pilots.

The state-of-the-art in-flight controller development is a moving target, and with several years of

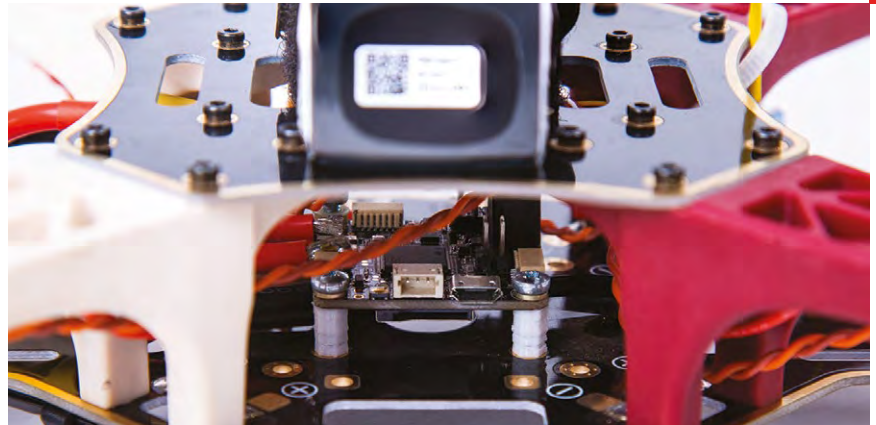

development now behind us in terms of affordable models, there is a huge choice to be found. At the lower end there are models based upon the technology of a few years ago that will provide a basic flying experience, but if you are building one in 2018 it makes sense to use a controller appropriate to the present.

Of the many choices, we are going to direct you to one of the recent models featuring the STM32 microcontrollers. You will see various different specifications, usually something like 'F3', 'F4', or 'F7' – these refer to the different revisions of the STM32 line. The higher the number, the more capable a component, so we would suggest getting an F4 or an F7. The other features you will be looking for are a so-called BEC or battery eliminator circuit to provide low voltage for the electronics, an input voltage range to match your battery choice, and a barometer chip that will allow the controller to maintain an altitude.

THE HIGHER THE VOLTAGE, THE LESS CURRENT REQUIRED FOR A GIVEN POWER, SO IN OUR BUILD WE OPTED FOR A 4S PACK

Our choice of an Omnibus F4 controller also gave us the option to monitor the battery current, and an on-screen display system, should we upgrade with a first-person video camera.

The controller itself is only half the story though, because it is simply a piece of hardware. Its real capabilities come through its software, and here at the time this is being written, the choice we would recommend is the popular Betaflight firmware. This should be pre-loaded, but you will often want to upgrade your controller over USB with the latest version. →

THE BETAFLIGHT CONFIGURATOR SOFTWARE

B

etaflight is a firmware package for multirotor flight controllers, that sits on the STM32 inside your controller,

and does its job of keeping your craft in the air.

The trouble with a flight controller though is that it is not a computer like the one on your desk, with a nice user interface, a screen, and keyboard. It has a lot of configurable options, but needs some means to access them. This is something the developers have addressed through a configuration tool, the Betaflight Configurator.

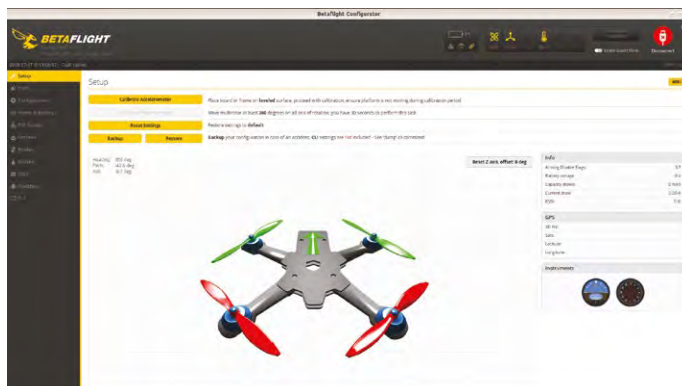

Right  You can configure a lot about your controller, but start with the basics

THE TOOL ITSELF TAKES THE FORM OF A GOOGLE CHROME EXTENSION, WHICH CAN BE FOUND IN THE CHROME STORE. IT SHOULD THEREFORE WORK ON ANY PLATFORM SUPPORTED BY CHROME

be prompted to download a more recent version. Assuming that your flight controller is plugged into your computer's USB port, you should be able to click on the 'connect' icon in the Betaflight Configurator home screen, and be rewarded by a status screen showing some of the current settings of the board, as well as its altitude. Try lifting the craft, and watch the diagram of it on the screen move accordingly

On the left-hand side is a menu containing a host of pages with all the detailed Betaflight options. The full functionality of Betaflight is beyond this piece, and while we would like to encourage you to read the full documentation and learn its capabilities, it is strongly recommended that you leave the default settings in place until you are confident with your machine, unless you have real reason to change them. That said, you will probably have need to go into the configuration screen if you have any radio issues, and the receiver screen on which you can check the received values for your different channels. You can also update Betaflight on your controller to its latest version, but this is also an advanced function, and best left alone unless you are confident you know what you are doing.

The tool itself takes the form of a Google Chrome extension, which can be found in the Chrome store. It should therefore work on any platform supported by Chrome. Once you have installed it, you may

COMMANDING YOUR CRAFT

Choosing a radio

In earlier decades, remote-control systems for model cars and aircraft were simple affairs. All transmitters and receivers were compatible with each other, so long as they shared the same frequency, and they would have been paired with each other by having matching plug-in quartz crystals. Their modern descendants have a hugely expanded feature set, but at the cost of greater complexity and a few pitfalls for the unwary buyer.

All the transmitters and receivers you are likely to encounter will use the same frequency band, 2.4GHz. There are no channels as there were in the old days; they share the same frequency and operate by pairing the code on the receiver with that on the

transmitter, by pressing a button on the receiver at power-on and starting the transmitter in a special pairing mode.

All transmitters are no longer compatible with each other, there are a variety of competing protocols on the market, and it is easy to make the mistake of buying the wrong ones and ending up with a mismatch. We STRONGLY suggest buying your transmitter and receiver together as a package, to make sure that you know they will work with each other, or at least buying them from the same manufacturer and ensuring that they both speak the same protocol. We bought a relatively inexpensive transmitter, a FlySky, for our build because this article is intended to be as accessible as possible, but you will find transmitters and receivers with prices rising up into the stratosphere.

The receiver will be a small board or module that will connect to the flight controller with a single serial cable. There are several protocols for this communication, for example SBUS, IBUS, or PCM. SBUS seems to be the favoured one, but in our case we must admit that we had significant problems getting our receiver and controller to speak to each other using it, and had to fall back to the somewhat inferior PCM.

The receiver should be able to draw its power from the BEC circuit on the flight controller, but the transmitter will require its own batteries. Frequently these are just domestic AA cells, or sometimes an internal Li-poly pack. →



Above ♦ Our FlySky FS-i6 transmitter, a budget model that shouldn't break the bank

FURTHER READING

We're only just scratching the surface of multirotor building here, and there's a fantastic range of information available online.

Whether you're looking for a bigger, faster, or lighter drone, you should find what you need to extend your skills. These are some of our favourite resources:

- Oscar Liang (oscarliang.com)
- GetFPV (getfpv.com/learn)
- RCGroups (rcgroups.com)

getfpv / learn

NAVIGATION GETFPV

FPV build logs and buying guides, just to mention a few.



Building a Simple DIY FPV Launch Stand

FPV DIY: Repairs and Mods • By OSprey • August 6, 2018 • 1 Comment

Goggle's down, thumbs up for video, on the tone in less than 5..... LAUNCH! In this article, I'll show you the process of building your own low-cost DIY FPV launch stand. A launch stand helps a quad to take off from a high angle (sometimes nearly vertical) by providing a soft, elevated surface for the...

Details »

BUILDING THE MULTIROTOR

S

o, given the previous sections, you should now be sitting at your bench with all the parts of a multirotor set out in front of you. One might think then that now would follow a step-by-step assembly guide. But

perhaps surprisingly, that's not exactly the direction we'll take. If you are a maker, you will know one end

of a screwdriver or a soldering iron from the other – and that is, to a large extent, the skill you'll need to assemble a multirotor. Off-the-shelf components are designed to be assembled in this way, so instead of giving you a screw-by-screw guide, it's better to pull out a little on the mundane, and zoom in only on the unusual or problematic parts.

Before you start, though, it's worth ensuring that you have the sundries you will need.

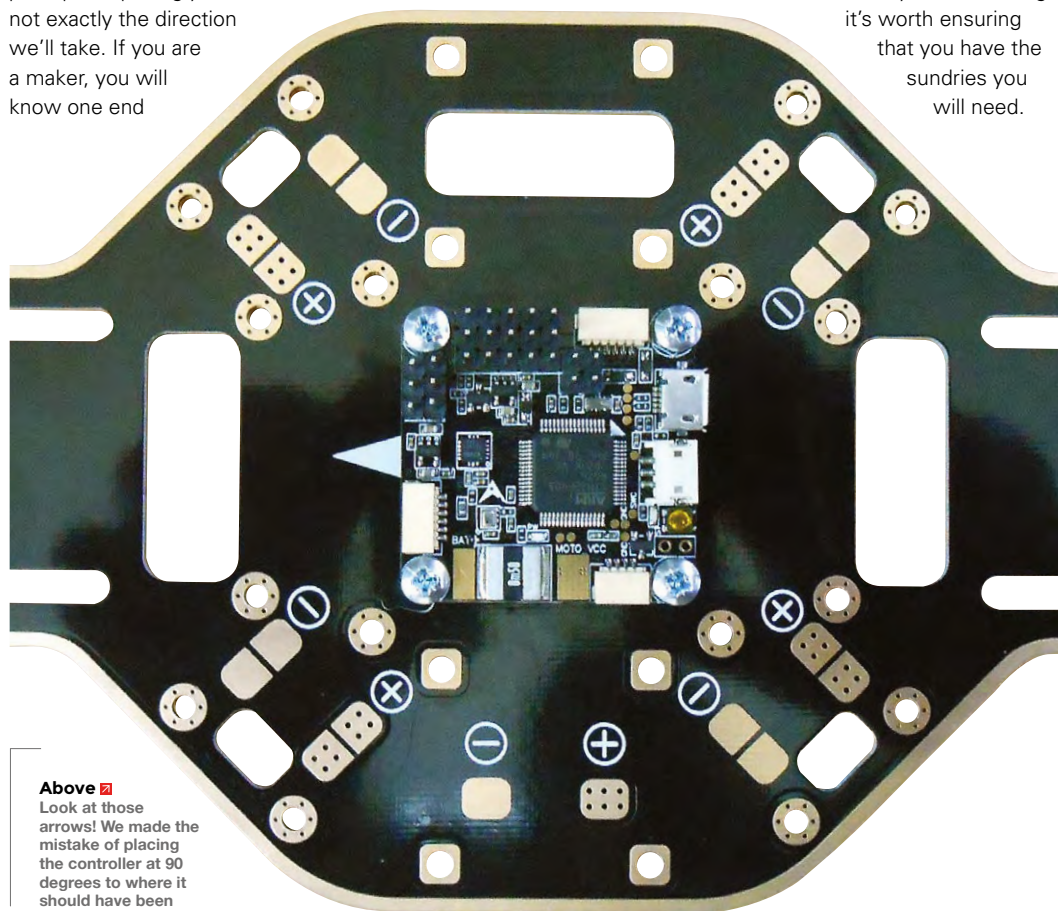

Above  Look at those arrows! We made the mistake of placing the controller at 90 degrees to where it should have been

M3 screws, washers, and stand-offs, for example, and cable ties, foam tape, and heat-shrink sleeving. If your flight controller doesn't have them fitted, then you may also need to find some 0.1" pitch PCB pins. In our case, we had neglected to buy the stand-offs, so we had to make a quick trip to Thingiverse for a model of one to 3D-print.

You will also need to source battery connectors, and we suggest the ubiquitous XT60 variety, and suitable silicone-insulated wire to carry your battery current. Some Velcro battery straps to hold the battery to the frame will also be useful, though at a pinch you could use cable ties for the same task.

Assembly of a commercial multirotor frame should be a straightforward case of screwing it together, but you may wish to mount the motors on the end of the arms and attach the speed controllers to them, such that you attach the arm to the frame as a complete pre-assembled unit. Remember that alternate rotors will need to rotate in opposite directions, so take care to wire your motor controllers appropriately, with two of the wires reversed on two of the arms. In most cases, the controller will have large solder pads for the motor wires; you will need to solder these connections, as well as solder their power wires to the power distribution board. When you are done, place a piece of foam tape onto the underside of the speed controller, and attach the whole to the arm with a cable tie. The foam tape will provide the required cushioning during the vibration of flight.

A pitfall lies in the positioning of the flight controller relative to the frame, it contains the machine's direction sensor, so in a sense its front and back define the front and back of the finished craft. On the controller PCB will be an arrow, which must be aligned with the front of the frame. We first assembled our build with the controller at 90 degrees to the frame, and spent a while confused because the machine tried to fly sideways.

ASSEMBLY OF A COMMERCIAL MULTIROTOR FRAME SHOULD BE A STRAIGHTFORWARD CASE OF SCREWING IT TOGETHER

The flight controller will have ports for the four motor controllers, and you will need to refer to the helpful diagram, provided by the Betaflight control software, to identify which motor should be connected to which one. The SBUS/IBUS/PCM port will also need connecting to the receiver, which you will need to cable-tie securely to the frame with its antenna out of reach of the rotors. →

Below ♦
Go slowly at first, as drone controls can take some getting used to



COMMISSIONING YOUR MACHINE



When you have assembled the machine, before you fit the propellers, you should first give it a full visual check, to ensure that you catch obvious problems.

Then, connect a USB cable to the flight controller, plug it into your PC, and run the Betaflight Configurator software. This should power up only the controller and receiver, and allow you to verify that the controller and radio are working, and configure any settings you may need. Only when you are satisfied that all is in order should you connect the battery, and spin up the motors by operating the throttle. With no propellers fitted, there will be vibration when the motors spin up, but the scope for damage will be limited. You should be able to tilt the machine and see the different motors spin up as it attempts to right itself.

At this point, it's worth talking about another pitfall. When we first flew our machine, we had a small crash and broke a propeller. Not unexpected, and fortunately we'd bought spare propellers, as

you should too. So, why did we crash? Straight out of the box, our machine had extremely sensitive controls, to the extent that though it appeared to work during our tests, in flight it was very difficult to manoeuvre. The solutions were straightforward enough – in its default settings, our flight controller was set to fly in acro mode. This is a mode used by racers and other advanced fliers, in which a lot of the stability features in the flight controller software are turned off, and instead of automatically trying to maintain level flight, our machine was all over the place. We had to enable self-levelling mode (called 'angle' in Betaflight Configurator, on the modes screen), and bind it to our arm switch for everything to return to normal.

We also decreased the sensitivity of our controls. There are two places this can be done, either by adjusting the rate and exponential settings on our transmitter, or the way we did it in Betaflight Configurator, by reducing the RC rate settings on the PID tuning screen. We strongly suggest that you don't touch any other PID settings, unless you really know what you are doing.

READY FOR FLIGHT

A multirotor might seem fairly harmless, but it can be a dangerous machine. There is significant energy in those propellers, and catching a finger or hand in one at full speed can cause injury and pain. Once we attach the propellers, it is important to treat the machine as potentially dangerous. Be careful not

Below ♦ The FlySky rate-expo screen, showing settings to desensitise the controls

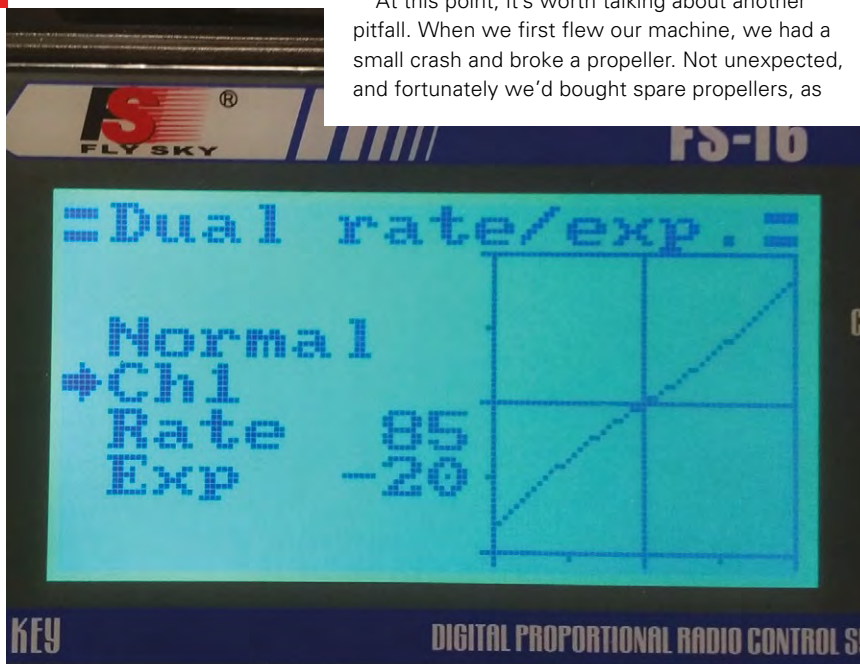



to come into contact with spinning propellers, and only arm and operate it when you are sure it's in a safe environment.

The propeller fits over a collar that locates on a conical piece of metal, with a screw-on cap holding it all down. Ensure that the caps are screwed down as tightly as possible, or you risk it coming off in flight.

Now, tie the machine down securely to something heavy enough to stop it taking off. Now, reconnect the battery, turn on the transmitter, arm it and, very gently, advance the throttle. It should be obvious if there are any problems, because the machine will vibrate or try to turn. In our case, it tried to turn itself before one of the propellers came off, indicating that we hadn't tightened its retaining cap sufficiently. Reattaching it and tightening it properly resulted in a stable machine. If you are at that point, then very gently work the controls to see whether the craft tries to turn or move. Do not push the throttle up too far, instead move it up only far enough to prove that it moves.

Disarm the transmitter, and disconnect the battery. Now tie down the four corners of the craft

to a secure anchorage with a couple of feet of lightweight rope. You should then be able to fly it to the limit of the rope, and further test the controls and the stability of the craft.

If your multirotor behaves as expected, you should now be able to fly it for the first time. Find a clear,

Above ♦
The different coloured arms make it easy to tell which way is 'forward'

SUPPLIERS

We have used parts sourced from the following suppliers. There are many more, this is by no means a comprehensive list.

- **Banggood.com:** an inexpensive direct-from-China supplier
- **Hobbyking.com:** a fantastic selection of RC parts
- **Amazon.co.uk:** is there anything it doesn't stock?
- **UnmannedTechShop.co.uk:** a British store, useful when you need parts in a hurry

A MULTIROTOR CAN BE A DANGEROUS MACHINE

open space in which you have permission to fly, and in which you can keep the craft over 50 metres away from the general public. Even if you can already fly a multirotor, you should exercise extreme care with the throttle, only advancing it just enough to get the craft into the air and test its manoeuvrability, being ready to safely bring it down and disarm it, should anything be amiss.

Once you are happy with its construction and performance, congratulations! You have made yourself a multirotor! Fly it responsibly, and enjoy it. □

Power a robotic sentry with facial recognition and Google AIY Vision

Using the Google AIY Vision Kit and some plumbing parts, we built this robot, which is just as fun to play with as to make



Andy Clark

workshopshed

Until now, garden sprinklers have been dumb pipes with predictable motion. Fun to play in, but not much of a challenge. This project gives the sprinkler a brain and vision so that it can target passing humans for a soaking they will never forget.

BUILDING A BRAIN

The brain and eyes of our robot are a Google AIY Vision kit. These are for sale in the USA at the time of writing and should be on sale in the UK soon.

The kit consists of a Pi Zero W, Pi Camera V2, Vision Bonnet, a switch and a buzzer, along with assorted cables. Google has provided detailed instructions on assembling the AIY Vision Kit which we followed carefully. We found the ribbon cables particularly fiddly, and there are two different kinds of zero insertion force connectors for these.

WE HAVE THE POWER

To make our game portable, and to reduce the risk of a nasty accident with electricity, the project runs from batteries, naturally.

We used a three-cell LiPo battery designed for radio-controlled vehicles; this outputs 11.1V, which is high enough to activate the mechanical parts of the project. Along with this we added a 'battery eliminator module' (BEM) which is the RC world's name for a DC to DC converter or regulator. The BEM drops the voltage down to 5V for the Pi.

The Vision Kit does not have a simple way to shut down the Pi, and suggests logging in and using the **shutdown** command before powering off. To make the project a bit more practical, we added a Pimoroni



Above
Our robot water sentry, cunningly disguised as a flower

OnOff SHIM power switch. This is wired up to the waterproof button on the top of the case. To drive the digital servo, we needed I²C, so extra wires were added for that. The OnOff SHIM comes with software to safely shut down the Pi before turning off the power.

WARNING: the default install seems to affect the AIY software, which is sensitive to being updated. So the daemon to shut down the software should be installed manually.

YOU'LL NEED

- Google AIY Vision Kit
- Waterproof box
- Waterproof button
- Big servo
- OnOff SHIM
- Battery
- Waste pipe
- Solenoid valve
- N-Channel MOSFET
- Garden sprayer
- Hosepipe fittings and nozzle
- Funky foam

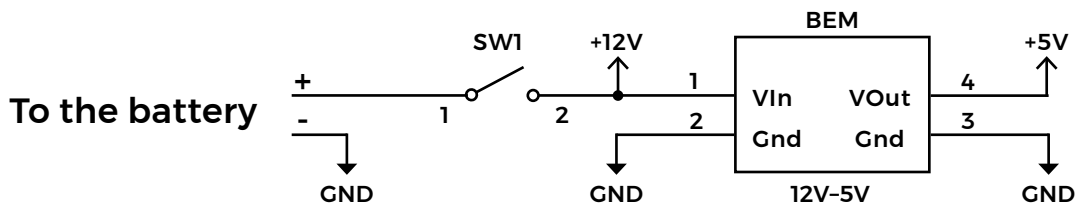

We also added a waterproof toggle switch to isolate the batteries from the circuit.

SOLENOID VALVE

A solenoid valve is a mechanical valve that is actuated via a magnetic coil. The GPIO pins are not capable of providing sufficient current to directly activate this solenoid. For this we used a driver circuit, consisting of an N-Channel MOSFET and some discrete components. R1 limits the maximum current from the GPIO, R2 ensures the MOSFET is turned off when power is removed, D1 provides a path for the stored energy of the coil when the circuit is turned off.

WATER WORKS

The plumbing aspect of the project is quite simple but is worth spending time on to avoid leaks. The driving force for the water is a garden sprayer to make the project portable. Hosepipe quick disconnects were used, allowing the project to be quickly packed away.

So that the head of the sprayer can be turned, we used another quick-release hose connector. This was mounted on some metal brackets, with a smaller bracket attached to act as a lever. The lever was linked to the servo horn using some coat-hanger wire.

To disguise the weaponry, we added a flower made from funky foam.

We found a solenoid valve with ½-inch threads that connected to the screw threads of the hose fittings, and used a jubilee/hose clip to hold the tubing onto the sprayer.

BOXING IT UP

As mentioned, electricity and water don't mix. Neither does cardboard. So, our Vision Kit needs some protection. We took a waterproof box and

HARDWARE SPECS

- Intel Movidius Myriad 2 MA2450 vision processing unit (VPU) chip
- Microchip SAM D09 (same as in the Arduino Zero, MKR1000, and MKRZero boards)
- Four GPIO pins controlled by the MCU
- Pi Camera V2

added a window using some thin polycarbonate sheet and Sugru to seal. Next, a tank connector and waste-pipe were added and sealed. This raises up the electronics and camera to get a better image. Wires were threaded through the pipe and out through a grommet.

JUMBO SERVO

To move our nozzle, we need a motor and a way of knowing the position it's in: in other words, a servo. Some quite large servos can be bought from robotics or RC model suppliers, but these are also expensive. We already had a big 12V motor with a reduction gearbox, so a linear potentiometer and 3D-printed gear were added for the position. This was wired up to a small Arduino board to control the motor. For communication to the Pi, we decided to use an I²C protocol rather than the standard analogue PWM approach used for off-the-shelf servos. The reason for this is that it allows us to read back the current position into the Pi and avoid the twitching movement on startup that happens with analogue servos.

We used an Adafruit ItsyBitsy as the control board. An H-bridge controls the speed and power of the motor, and a potentiometer provides the position feedback.

The servo code consists of the standard Arduino setup and loop, along with some extra functions for handling the I²C commands and requests.

The start of the code consists of constants for the pins and I²C parameters. The variables that could →

Below OnOffSHIM and power

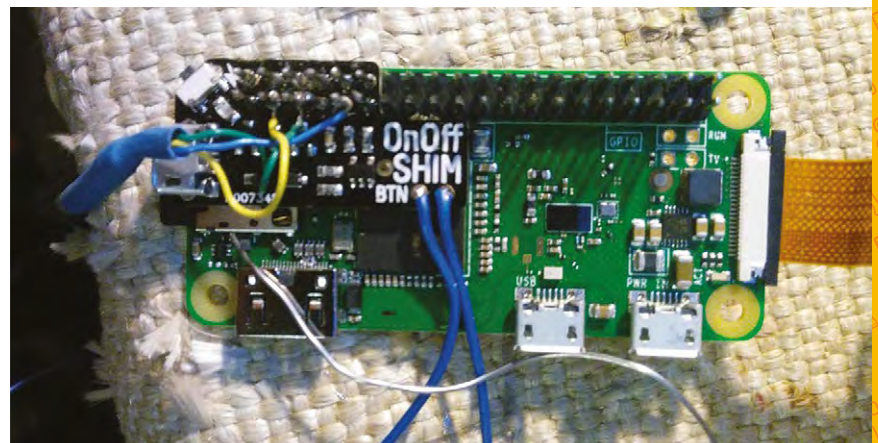

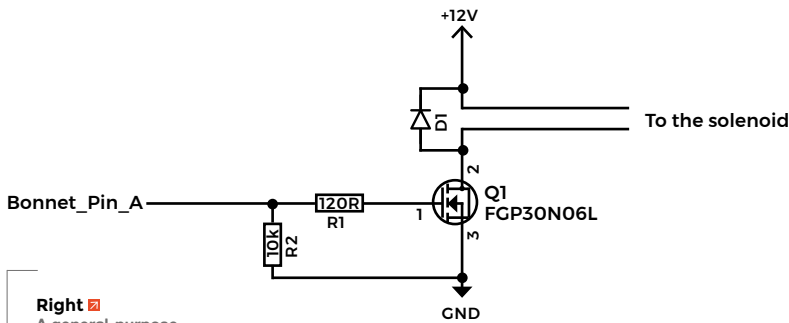

Right A general-purpose low-side driver circuit

be changed by the wire events are marked as volatile so that the compiler does not optimise their use by swapping in constant values.

```
#include <Wire.h>

const int slaveAddress = 8;

const int sensePin=A0;. //Needs to support AnalogRead
const int drivePin1=3;
const int drivePin2=4;
const int speedPin=5; //Needs to support PWM

enum readRegisters { Target = 0,
                    Running = 1,
                    Position = 2,
                    Speed = 3,
                    Direction = 4};

enum commands { CmdStop = 1,
                CmdAngle = 2,
                CmdSpeed = 3,
                };

volatile int registers[5];
volatile int readCmd;
```

In the setup, we configure the pins used to drive the motor and ensure the motors are off.

Wire.begin defines the address used by the servo. If you had multiple servos, you could use an EEPROM to store this address.

Wire.onReceive and **Wire.onRequest** registers the functions that are called when data is received on the I²C bus. These are often called event handlers or callbacks.

```
void setup() {
    stop();

    pinMode(drivePin1, OUTPUT);
    pinMode(drivePin2, OUTPUT);
    pinMode(speedPin, OUTPUT);
    pinMode(sensePin, INPUT);
}
```

```
Wire.begin(slaveAddress); // join i2c
bus with address #8
Wire.onReceive(receiveEvent); // write data
Wire.onRequest(requestEvent); // requests to
read data
}

void stop() {
    digitalWrite(drivePin1, LOW);
    digitalWrite(drivePin2, LOW);
    analogWrite(speedPin, 0);
    registers[Running] = false;
}
```

The loop is used to record the position of the potentiometer and check if we have reached the target position. Once the target position has been passed, the motor is stopped until a new position command is sent.

```
void loop() {
    registers[Position] = analogRead(sensePin);

    if (registers[Running]) {
        analogWrite(speedPin, registers[Speed]);
        if (registers[Direction] == 1) {
            if (registers[Position] >=
registers[Target]) {
                stop();
            }
        }
        if (registers[Direction] == -1) {
            if (registers[Position] <=
registers[Target]) {
                stop();
            }
        }
    }
}
```

The **receiveEvent** function takes the data from the host computer and acts on the various commands. It is important to read all of the data sent, or the handler will not get called again. Each of the messages consists of three bytes: the first is the command and the second two are the high and low bytes of an integer parameter.

```
void receiveEvent(int bytesReceived) {
    char command;
    int value;

    if (bytesReceived == 1) { //Read request
register
        readCmd = constrain(Wire.read(),0,5);
    }
```

GPIO

The Microchip MCU on the Vision Bonnet handles the buttons, LEDs, and buzzers in the kit. It connects to the Pi via I²C so it can handle several I/Os without using the Pi's GPIO pins. Software handles pulsing lights and debouncing switches.

CHAIN DRILLING

Large holes can be made by drilling lots of smaller holes in a circle and cutting through with a saw. We used a half-round file to finish the edges.



Above ♦
How to cut a large hole

```

}

if (bytesReceived == 3) {
  command = Wire.read(); // receive byte as a
  character
  value = Wire.read();
  value = value << 8; // shift high byte to
  be high 8 bits
  value |= Wire.read(); // receive low byte as
  lower 8 bits

  switch (command){
    case CmdStop:
      stop();
      break;
    case CmdAngle:
      registers[Target] = value;
      registers[Running] = true;
      if (registers[Target] >
registers[Position]) {
        registers[Direction] = 1;
      }
      else {
        registers[Direction] = -1;
      }
      break;
  }
}

```

```

case CmdSpeed:
  registers[Speed] = value;
  break;
}
}
else
{
  //Invalid command throw buffer away so we
  can read again
  for (int a = 0; a < bytesReceived; a++) {
    Wire.read();
  }
}
}
}

```

The full list of commands which are supported by the motor are:

Status: Sets the status for when request is called

Stop: Stop the motor

Move to: Sets the target position

Speed: Sets the speed of the servo

The **requestEvent** returns the value of the register as already selected by the **CmdStatus** command.

```

void requestEvent() {

  String value = String(registers[readCmd]);
  char message[2];
  value.toCharArray(message, 2);

  Wire.write(message,2);
}

```

If you can locate a powerful servo, you can control that using GPIO Zero's **AngularServo** class. See the **ObjectMeter** example from the **Vision Kit** – you can find it on GitHub at hsmag.cc/GCEMXg.

WHAT IS TENSORFLOW?

TensorFlow is an open-source software library for numerical computation using data-flow graphs. A tensor is a multidimensional array of numbers. The **Vision Bonnet** works by having trained models that take an image in the form of an array, and produce a list of objects in the scene and a score as to how confident the match may be. For example, one model is trained to tell you what a plate of food contains, or if the image contains any smiling faces.

Below ♦
An IP67-rated box should keep water out



BRAIN POWER

The Google AIY Vision Kit has limited documentation, but there are good examples and plenty of source code. The software on the Vision Kit was made by combining the various Python examples. There are many prebuilt TensorFlow classifier models that identify different kinds of images. We used one that can detect people, cats, and dogs; our code just responded to people.

Many of the examples use an on-screen preview, but as we were not using a display, this proved not to be necessary.

The `import` lines bring in all of the various premade libraries to recognise images and talk to the hardware.

```
#!/usr/bin/env python3

from aiy.vision.inference import CameraInference
from aiy.vision.models import object_detection
from aiy.vision.leds import Leds
from aiy.vision.leds import Pattern
from aiy.vision.pins import PIN_A
from gpiozero import OutputDevice
from picamera import PiCamera
import time
import smbus
```

Variables are then configured for the I²C bus, solenoid, and the LEDs:

```
RED = (0xFF, 0x00, 0x00)
leds = Leds()
leds.pattern = Pattern.breathe(1000)
bus = smbus.SMBus(1)
slaveAddress = 8
solenoid = OutputDevice(PIN_A)
```

We start by turning on the button light so you know the code is running. Next, we start the image recognition from the camera. This is configured for 1640x1232 mode, which matches the training for the Vision Bonnet. If something is detected then we check if it is a human (`kind == 1`) and there is a good match (`> 0.7`). The position of the detected human relative to the centre of the image is then sent to the squirt routine, which is scaled by the width of the screen.

```
def main():
    # Turn on the LED so we know the box is ready
    leds.update(Leds.rgb_pattern(RED))

    with PiCamera() as camera:
        camera.sensor_mode = 4
        camera.resolution = (1640, 1232)
        camera.framerate = 30

        with CameraInference(object_detection.
            model()) as inference:
            for i, result in enumerate(inference.
                run()):
                for i, obj in enumerate(object_
                    detection.get_objects(result, 0.3)):
                    if obj.score > 0.7 and obj.
                        kind == 1: # Person
                        x, y, width, height = obj.
                            bounding_box
                        squirt((x + (width/2) -
                            (1640 / 2 )) / 1640)

if __name__ == '__main__':
    main()
```

OTHER IDEAS

- Use the width of the bounding box to estimate distance and get better targeting
- Train your own TensorFlow to squirt foxes or squirrels
- Train your own TensorFlow to look for wilting plants, and water them automatically
- Build an intelligent tennis trainer that can give you practice on forehand or backhand
- Instead of the Vision Bonnet, you could use a Movidius Neural Compute Stick to analyse your images

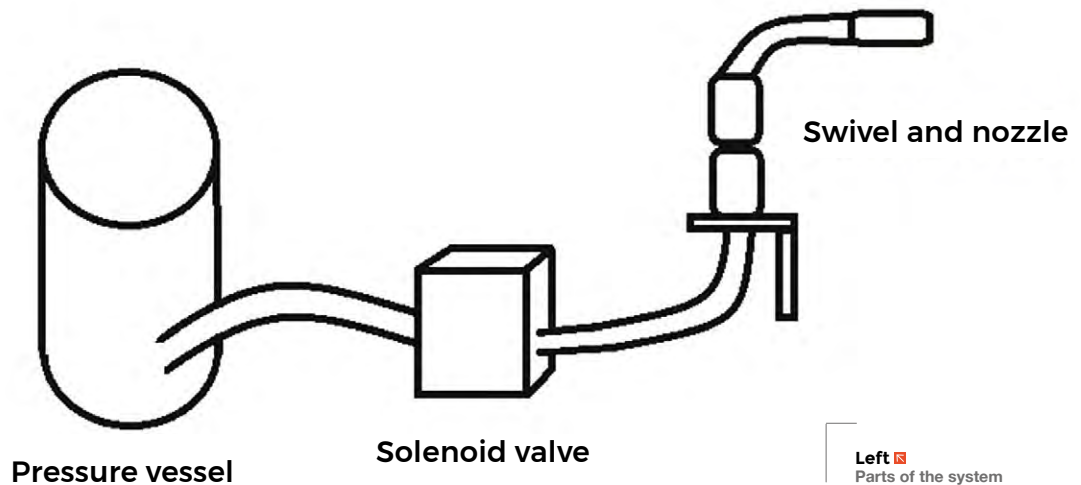

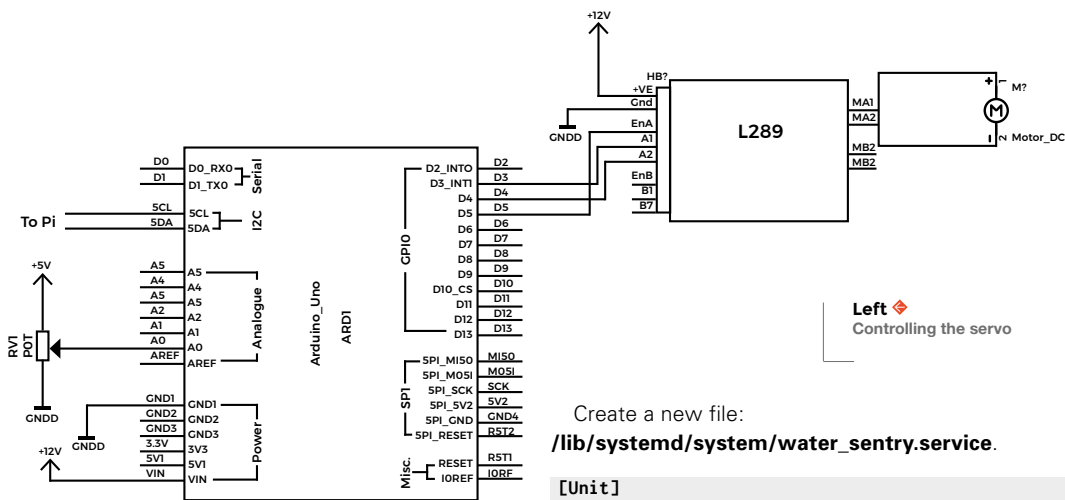

The squirt routine calculates the angle. When checked, the image distance at 2.5 m is approximately 2.9m wide. It then sends a command to rotate the servo and reads the `IsRunning` register until it stops moving. The solenoid is activated for 1s, and the light is turned to solid red. Finally, the solenoid is turned off and the light is set back to the breathe pattern.

```
def squirt (position):
    angle = math.degrees(math.atan((position/2.9)
    * 2.5))
    bus.write_byte_data(slaveAddress , 2, angle )

    while bus.read_word_data (slaveAddress, 1) !=
    0:
        time.sleep(0.1)

    leds.update(Leds.rgb_on(RED))
    solenoid.on()
    time.sleep(1)
    solenoid.off()
    leds.update(Leds.rgb_pattern(RED))
```

TURN ON AND OFFABLE

When the Vision Kit is first installed, it comes with a smile detector as default. We want to swap this out with a service to run our code.

First, we disable the smile detector.

```
sudo systemctl stop joy_detection_demo
sudo systemctl disable joy_detection_demo.service
```

Then we create a file that specifies the script we want to start. This consists of a title, plus parameters that determine that it runs as Pi and executes a Python script. Finally, the last parameter determines when the script is started; `multi-user.target` is run when most of the operating system is ready for use and the machine is ready for login.

Create a new file:
`/lib/systemd/system/water_sentry.service.`

[Unit]

Description=Robot Water Sentry

[Service]

Type=simple

Restart=no

User=pi

ExecStart=/usr/bin/python3 /home/pi/human_ detection_camera.py

[Install]

WantedBy=multi-user.target

The last step is to install and enable our startup service.

```
sudo systemctl enable water_sentry.service
sudo systemctl start water_sentry.service
```

PLAY THE GAME

To prepare the game, you fill the sprayer with water and prime it by pumping it with air. The sentry is then activated by pressing the button on the top.

At this point, the camera is activated and the Vision Bonnet starts looking for humans. If it locates a human, the coordinates are passed on to the control software which then moves the nozzle to point at the human. The controller then activates the solenoid valve, squirting the person.

If you've just got a Pi Zero, why not add a remote control to manually target the water? You could also use a Pi 3, Pi Camera, and OpenCV to create a software-based vision system. ❑

LEARN MORE

- Google machine learning crash course: hsmag.cc/GczwaP
- Getting started with picamera: hsmag.cc/iKKczp

Making things add up

Eric Coates explains the basic electronic circuits used in computer arithmetic



Eric Coates

hsmag.cc/cabTmd

Eric Coates, BSc (Hons) MA has lectured on electronics in technical colleges and acted as examiner and moderator for several UK technical educational boards. He is the founder and CEO of learnabout-electronics.org

Right

The complete half adder circuit built on a breadboard

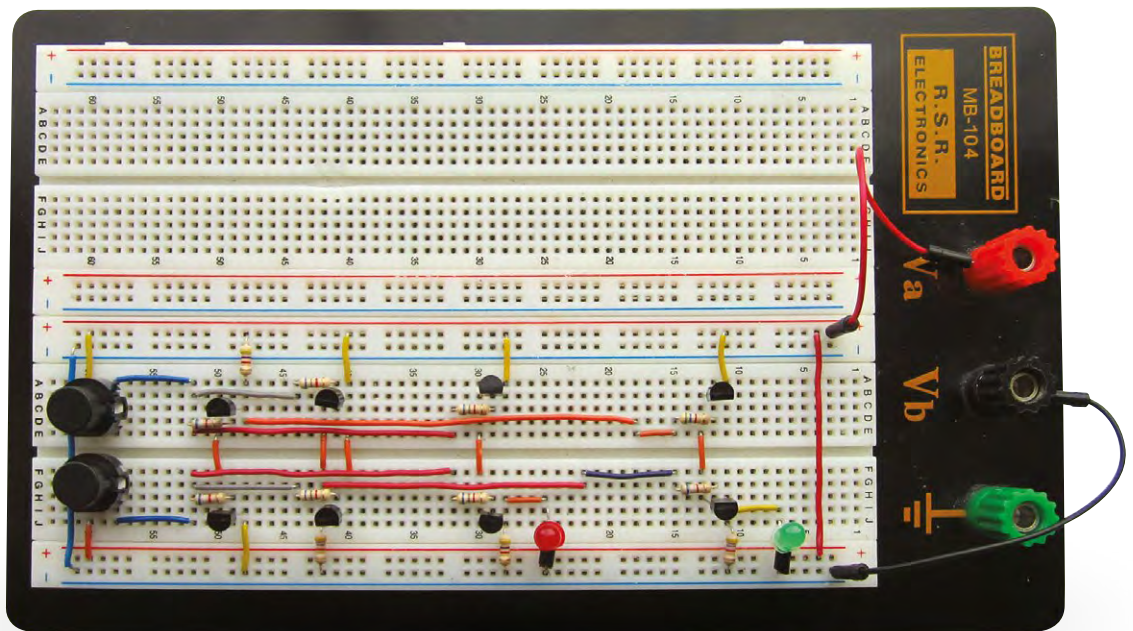

Computers can carry out an awesome amount of mathematics; we all know that. So how come all of this can be performed on a machine that can only add 1 and 1; no subtraction as we know it; no multiplication and no division?

The answer is that an electronic adder circuit that just adds 1 + 1 and uses a few tricks of the binary system can, with some help from a little firmware code, carry out any arithmetic we need at an amazing speed. The simple electronic calculator circuit at the heart of this wizardry is known as the Half Adder and is shown, made from just a couple of logic gates (an Exclusive OR gate and an AND gate), in **Figure 1**.

The 'half' in its name is because, while it can add 1 plus 0 and even add 0 plus 1 to get the correct answer of 1, as shown in the 'Sum' column of the truth table in Figure 1, if it adds 1 plus 1 in binary, this produces the (decimal) answer of 2, which in binary notation is 10, so a second column is needed in the form of a 'Carry' output to hold double the value of

the single-digit sum output, producing the answer of 10 (decimal 2). This is fine if we only need to add a single column of binary, but the half adder cannot cope with multi-column numbers where a carry may be produced.

THE HALF ADDER'S BIG BROTHER

Because the half adder can only add two 1-bit numbers in a single column, it does not usually work alone. However, if the carry output produced by the half adder can be used as one input to another

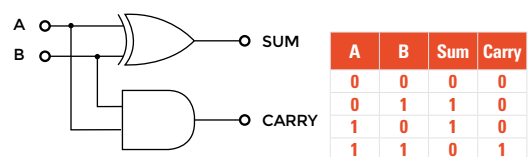

Figure 1 The half adder is at the heart of all electronic calculators

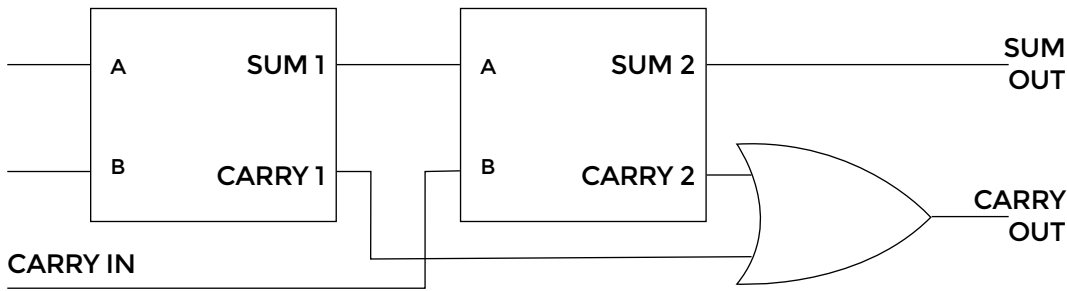

Figure 2 ♦ Two half adders make one full adder that can cope with multi-column addition

half adder, the two circuits combine to form the full adder shown in **Figure 2**, which will now have three inputs and so can add two binary bits in any one column using inputs A and B, plus any ‘carry in’ from a previous column, making multi-column addition possible.

So, the half adder may not carry out an impressive amount of arithmetic, but as it only takes around 30 nanoseconds to produce its answer, this basic adder could therefore carry out around 100 million similar calculations per second, which is how, when coupled with another half adder and other bits of electronic circuitry, many simple 1+1 additions are made to look like powerful maths, when it’s really simple arithmetic, only at a blazing speed!

THE HALF ADDER DISSECTED

The most complex part of the half adder is an Exclusive OR (XOR) gate, which produces an output of logic 1 when its two inputs are different (01 or 10), but an output of 0 when the two inputs are the same (00 or 11). XOR gates comprise rather more electronics than the other more standard gates, which makes them slower, therefore less popular and more expensive than the other standard gates. However, the Exclusive OR logic function can be, and very often is carried out by a combination of more regular logic gates, as shown in **Figure 3** where the XOR gate is replaced by a combination of AND, OR and NAND gates, and this

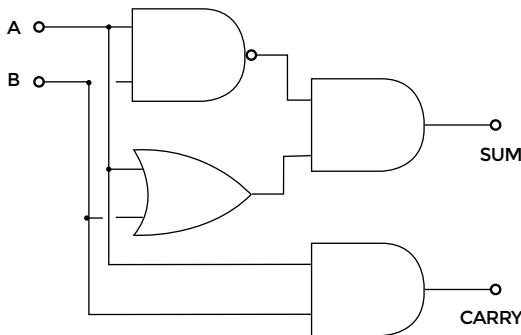

Figure 3 ♦ Equivalent half adder circuit using standard logic gates

is the approach we shall use in our transistor/resistor version of the half adder.

So why, when logic gates are readily available in integrated circuit form, and you can easily simulate their operation on a computer screen, would you want to build them from basic electronic components such as resistors and transistors? Well, these days when the Internet of Things is becoming more and more important, the skill of combining computers such as the Raspberry Pi or Arduino with external electronic circuits and devices is becoming vital. It’s one thing to move things about on a computer or smartphone display, but different skills are needed to drive output devices and make things change in the real world. Therefore it’s more vital than ever to understand the operation of electronic circuits at component level, and to develop the knowledge and skills needed for constructing working circuits such as the half adder.

THE AND GATE

Our half adder circuit will contain two AND gates, both working to produce the truth table in **Figure 4**. →

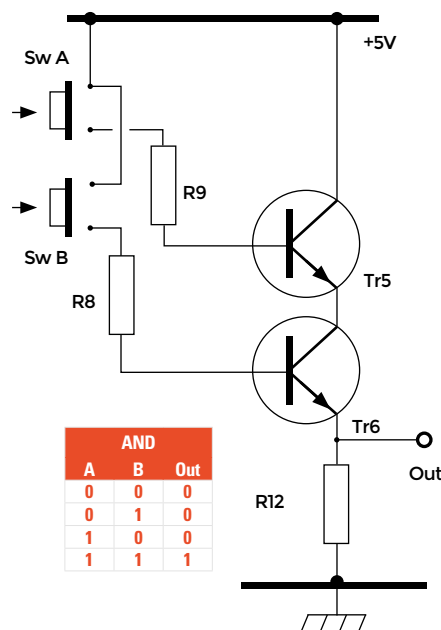

Figure 4 ♦ The AND gate output produces a logic 1 when, and only when, both inputs are at logic 1, otherwise the output is at logic 0

YOU’LL NEED

- ♦ **Transistors**
8× 2N3904
- ♦ **Resistors**
4× 4.7 kΩ (4K7)
for R1, R10, R11 & R12
- ♦ **8× 6.8 kΩ (6K8)**
for all other resistors
- ♦ **Switches**
2× Mini push to close
- ♦ **2× 5 V LEDs**
1× Kingbright L-53GD (5 mm green) and
1× Kingbright L-531D (5 mm red) are
ideal and need no
limiting resistors
- ♦ **Breadboard and wire links**
- ♦ **5 V Power supply**
(only 20 mA current needed)

Figure 5 (Right) ♦
The OR gate output produces logic 1 when either input or both inputs are at logic 1, otherwise the output is at logic 0

Figure 6 (Far Right) ♦
The NAND gate output produces logic 1 when both inputs are at logic 0, otherwise the output is at logic 1

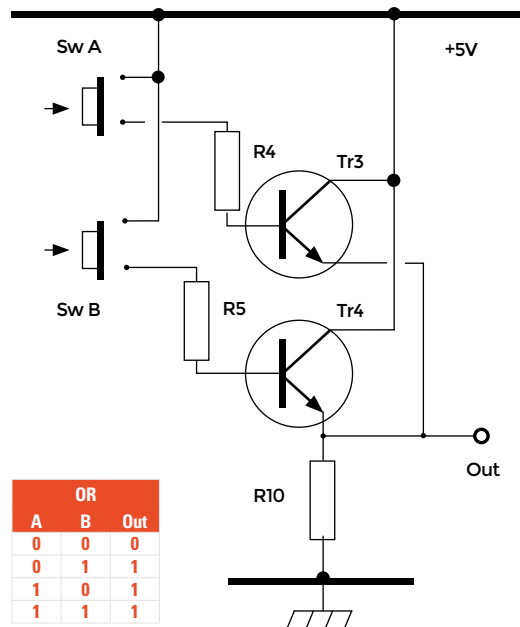

OR		
A	B	Out
0	0	0
0	1	1
1	0	1
1	1	1

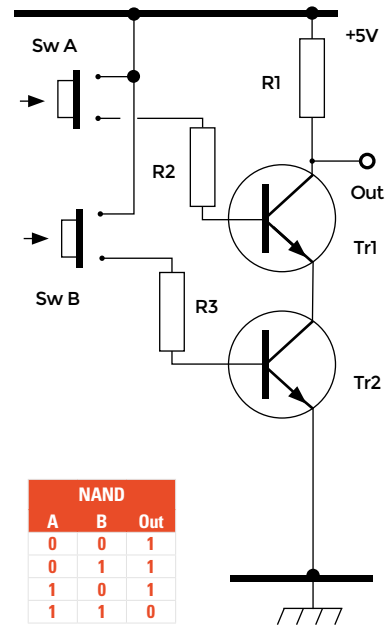

NAND		
A	B	Out
0	0	1
0	1	1
1	0	1
1	1	0

QUICK TIP

Before you build the circuit shown in Figure 7, it's a good idea to build each of the individual gate circuits in Figures 4 to 6 separately to begin with, so you can test each circuit to make sure they give the results shown in their respective truth tables. If you fit the two input switches to the breadboard first, you can use these to test each of the gate circuits. You'll also need to include the two output LEDs. Building these three logic gate circuits separately will enable you to find the best layout for each gate circuit and help you to understand how each gate circuit works before attempting the complete half adder.

Notice in this circuit that the two transistors Tr5 and Tr6 are effectively connected in series; that is, the same current will be flowing through Tr5 (collector to emitter) and through Tr6 (collector to emitter). Therefore, for this current to develop a voltage across R12, both transistors must be conducting. All the transistors in the whole of the half adder circuit are operated in switch mode; that is, they will either be switched on, by a large enough current flowing into their base connection to cause the transistor to conduct heavily, or switched off by removing the base current and therefore preventing any collector/emitter current. The base current for Tr5 and Tr6 depends on the values of R9 and R8, which are both 6.8kΩ, and the switches Sw A and Sw B are used to simply connect R9 and R8 to the +5V supply.

So, when both transistors are switched on, the current through Tr5 and Tr6 will develop an output voltage across R12 (4.7kΩ) equal to the supply voltage, minus a small voltage drop due to the voltages across the PN junctions in Tr5 and Tr6.

As shown in Figure 3, one AND circuit will be used to drive the Sum output of the half adder and the other AND circuit will drive the Carry output.

THE OR GATE

As in the AND gate, the transistors here are being used as electronic switches and are activated by the currents flowing into their bases from Sw A and Sw B via the 6.8kΩ resistors R4 and R5 (Figure 5). However, in this circuit the transistors Tr3 and Tr4 are connected in parallel, with the collector of Tr3 connected directly to the collector of Tr4

and the emitters of both transistors also connected together. Therefore if either Tr3 or Tr4 is made to conduct, a voltage almost equal to the +5V supply will be developed across the output resistor R10. This therefore produces

“ The half adder does not carry out an impressive amount of arithmetic, but it only takes around 30 nanoseconds to produce its answer ”

what we shall call logic 1 at the output if Tr3, Tr4 or both transistors are made to conduct, fulfilling the requirements of the OR truth table and in the total half adder circuit, driving one of the inputs of the Sum AND gate as part of Figure 3's XOR function.

THE NAND GATE

Comparing the truth tables for the NAND gate in Figure 6 and the AND gate in Figure 4, it can be seen that the output columns of each table are the opposites of each other. This tells us that the circuit for the NAND gate will be similar to that of the AND

gate, but the outputs will have opposite logic values. Compare the circuits in **Figure 4** and **Figure 6** to see how this is done. The $4.7\text{k}\Omega$ output resistor R12 connected from Tr6 emitter to ground in **Figure 4** is simply moved to become R1 in **Figure 6**. Now if both transistors in **Figure 6** are made to conduct at the same time, the voltage at the bottom of R1 will be almost 0V so producing logic 0 at the output; if either one or both transistors are switched off, however, the current path from R1 to ground will be interrupted and the output terminal will remain at logic 1, fulfilling the logic requirements of a NAND gate.

Figure 7 illustrates how two AND functions (shaded green), as well as the OR function (shaded blue) and NAND (shaded pink) logic functions needed for a half adder can be interconnected to drive two 5V LEDs representing the Sum and Carry outputs. The LEDs used in this project are designed for +5V supply circuits and have built-in current-limiting resistors so extra current-limiting resistors are not needed – unless you decide to use standard LEDs, in which case you will need to fit an appropriate current-limiting resistor in series with the LED.

The photograph (page 86) shows a practical layout of the half adder circuit on a dual breadboard. You can follow this layout to make a working half adder circuit or develop your own layout, depending on the breadboard and wire links you have available. Notice that only one half of the double board space has been used, so if you are feeling brave why not build a second half adder in the remaining board space and link the two circuits using another OR circuit, as shown in **Figure 2**, to make a full adder?

The half adder may not be as familiar as other more recognisable parts of a computer system such as disk drives, sound cards and touchscreens, but computers can work quite well without these, as proved by devices such as the Raspberry Pi and Arduino. However, no computer – not the Raspberry Pi, not the Arduino, nor even your pocket calculator – can work without the half adder, one of the unsung heroes of computing!

If studying adders in this article has inspired you to find out more about them, and how binary arithmetic really works to give the basic adders described here the power to carry out some awesome arithmetic, take a look at hsmag.cc/qnFyCp, where millions of people dedicated to learning about electronics go to study these fascinating combinational logic circuits essential to computing, as well as many more digital and analogue topics. □

Figure 7 ♦
This is the complete half adder circuit, combining Figures 4 to 6

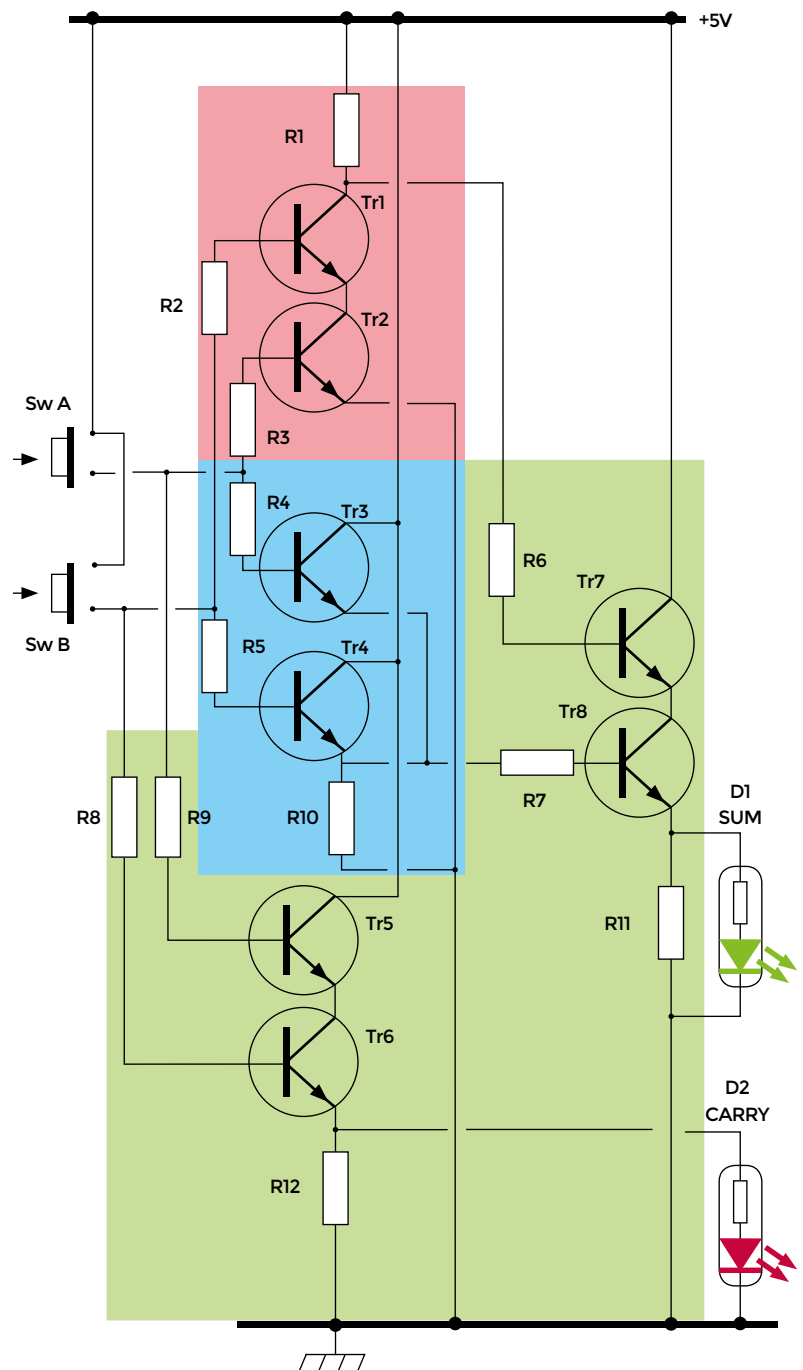

Rapid Whale Mini Boat

By Josh Tulberg

Rapidwhale.com

I'm a Bay Area maker – owner and operator of a ridiculously small one-man design shop, Rapid Whale. I have a knack for designing things no one wants (or is willing to pay for), so it's fitting that I designed such a small mini boat.

The Rapid Whale Mini Boat is only 6 foot in length, which I believe makes it one of the smallest mini boats out there (most are 8'). And as far as I know, it may be the first mini boat ever to be CNC laser-cut. Typically when you think of boat manufacturing, you think of CNC routers, or giant metal moulds for laying up fibreglass. With something as small as a mini boat, it becomes possible (and advantageous) to cut it with a laser. My laser cutter has a cutting zone of just 900mm x 1000mm (just under 3' x 2'), so that partly dictated the size of my boat.

The first mini boat I ever saw was Paul Elkin's 8-foot 'Little Miss Sally'. It was amazing, and it stuck with me for a few years. I became motivated to design and build my own mini boat once I discovered the simplicity of 'stitch and glue' boat building. I

spent countless hours designing and tweaking the boat in CAD before moving onto a scale-model, and then finally three full-scale production models.

My Dad, my good friend Dylan, and I built three of these boats at the same time in a garage. We knocked out most of the work in a weekend and took our time waterproofing and putting on finishing touches. When it came time to launch them for the first voyage, I had some idea of what to expect (knowledge from the CAD model, and the scale model) but was still largely uncertain as to how it would behave in the water. Lucky for us, the boats performed admirably. Primary stability was quite low, which is what allows us to lean into turns. Secondary stability was very good, which is what prevents us from actually flipping. That combination of stability is perfect for having a blast at low speeds, which is great because you aren't going any faster than 4mph with the electric trolling motors.

I'm looking forward to taking our boats out on many more adventures. □





Left  Josh's boat will carry a pilot up to 6 ft (183 cm) and 200 lbs (91 kg) in weight



Beautiful, unique knife handle

Make a super-sleek knife handle with a silver shilling, pearwood, and deer antler



Left ♦ Hand-sanding the handle to 2000 grit, then oiling, gives a stunning finish

LET'S MAKE A KNIFE HANDLE

First, you need a knife blade blank and a coin. The blade in this example is a Mora Nr 2/0. The coin is used as a bolster, which helps hold the blade in place laterally. The coin should be at least a little larger than the height of the blade. A silver shilling (pre-1947 actually has some silver in) is perfect for this blade size. Silver is also relatively soft and easy to work with.

Take your knife blade, place it on a sheet of paper, and draw all around the perimeter. Placing your coin bolster on the plan also helps you to size one end of the handle accurately. Draw the outline of the handle shape that you'd like to make. You can get inspiration from the internet, your kitchen knife drawer, or make something up. Or you can simply

Knife-making is a great hobby because you can create something beautiful and useful with six to ten hours of effort, over two to three days, for under £20 in materials. It's a chance to get creative, experiment, and make something unique and personal. The technique works with any wood, but hardwood is preferred for knife handles as it's less prone to denting. There's also something special about using wood harvested from your own garden. The example project uses wood from pear tree prunings (seasoned for two years).



Alex Eames



Alex Eames loves making things and regularly blogs/vlogs at RasPi.TV. He makes a living designing and selling RasP.iO products.



Right □ Design the handle to fit the parts you want to use by laying it all out on paper



Left ♦
A 1921 shilling is 50% silver, 50% copper, so is quite soft and easy to work with

copy the design from github.com/raspitv/knife to get started.

Once you've decided on the shape, choose a piece of seasoned hardwood larger than your final design by at least 5 mm in every direction. This gives you some margin for error. It's a lot easier to get the alignment right if you work from a planed square edge block of wood, but this example uses a piece of pear tree branch.

Choose a section of your antler that has a slightly larger diameter than the coin. When sanding to shape later on, the outer 'brown' part is removed, exposing the 'ivory-like' section underneath. So the antler cross-section needs to be chosen to fit the coin. Small deer antlers can easily be bought in pet shops, where they are sold as dog chews. You'll need about 1 cm length of antler, cut with perpendicular ends. Antlers can be cut with wood saws. The ends can be sanded (wear a mask).

Below ♦
The ring pattern of the wood grain often shows in surprisingly beautiful ways



BOLSTERS AND TANGS

The thin part of the blade embedded in the handle is called the 'tang'. You need to make a hole in the coin bolster so that the tang fits through until the coin is almost touching the start of the blade 'proper'. Ideally, the bolster should be a tight fit on the tang. Measure the blade cross-section at the top (wider end) of the tang, and draw the approximate cut-out on your coin with a felt-tipped pen. Use a Dremel-like multi-tool, with small cutting wheel and/or engraving bit, to remove material from the coin. It's best to iterate until you have achieved the desired fit. When it fits well, remove the coin and give it a good polish with Brasso, or some other metal polish. It's much easier to do it now than when it's on the knife.

Mark the antler in the position where you want the blade's tang to pass through it. This can be a fairly 'generous' hole and doesn't need to be a tight fit at all. It should be a little higher and a little wider than the cut-out in the bolster, to give you some wiggle room for alignment in glue-up. Drill the hole with a 5 mm drill bit or use an engraver. The middle part of the antler is 'honeycombed' and easy to work with. →

YOU'LL NEED

- ♦ **Piece of hardwood**
- ♦ **Knife blade, e.g. Mora Nr 2/0**
hsmag.cc/kbQAJR
- ♦ **Piece of deer antler** (often sold as dog chews in pet shops)
- ♦ **Coin** (eBay - silver is ideal as it is a soft metal)
- Tools**
- ♦ **5 mm drill bit** (long)
- ♦ **Power sander/detail sander, with coarse and medium abrasive paper** (e.g. 60, 120 grit)
- ♦ **Dremel, small cutting wheel, and engraving bit**
- ♦ **Wet and dry abrasives 400 to 2000 grit**
- ♦ **Varnish, polish, or oil**
- ♦ **Glue - Gorilla glue (polyurethane) or epoxy resin**
- ♦ **Band-saw, jigsaw, scroll-saw, or coping saw**

MAKING A KNIFE PRESS

A simple knife press can be made very quickly from two lengths of wood, two lengths of threaded rod, and four to six nuts. It's a lot less fiddly than using two separate clamps and pieces of wood. The threaded rod should be 30–40 cm long to allow for a variety of knife sizes. The wood should be something relatively soft, e.g. pine or spruce, to avoid damage to blade or handle. The knife blade will dig into it when clamped.



// You need to make a central hole in the wooden handle, deep enough for the tang, and wide enough to allow some free movement for alignment

WOOD YOU HANDLE IT?

You need to make a central hole in the wooden handle, deep enough for the tang, and wide enough to allow some free movement for alignment. A 4–5 mm drill bit (you may need an extra long one) is usually sufficient. Drill two adjacent holes and then merge them together, either using a milling action with the drill, or with small rasps or files. Be careful not to drill deeper than you need to and be sure to get the alignment right. A pillar drill can be a big help here if you have one.

If you need to, you can shorten the tang. But don't take too much off it because the longer the tang, the more glue area holding the blade firmly in the handle.

Rough up the tang with coarse abrasive paper. This is partly to clean it and partly to give the glue something to 'key' to. Then fit the bolster to the tang, slip the antler section over the tang, and trial-fit the tang in the wooden handle. Ensure it can all be made to line up straight. This is your last chance to make any adjustments to the antler section or hole in the wood. Once satisfied, it's time to glue it all together.

STICKING POINT

Polyurethane glue is ideal for knife making because it expands to fill gaps and is also waterproof. (You can also use epoxy.) Ensure the hole is free from excess sawdust, then squirt glue into the hole. You can use a bamboo skewer to push glue down and make sure it reaches to the bottom of the hole. It doesn't have to be completely full because the tang is also going in there and the glue expands. Ensure the bolster is correctly fitted to the tang. Spread some glue on the top side of the antler section and press it into place against the coin. Then glue the other side of the antler section and fit the whole assembly to the wooden handle. Ensure everything is aligned correctly, then press together using either two lengths of wood and two clamps or a knife press. You have about 30–60 minutes before the glue becomes unworkable.

Check alignment and leave clamped for at least four to six hours, preferably overnight. Gorilla glue sets hard overnight and fully cures in 24 hours. Some epoxies may be faster.

ROUGHING IT

Now you're going to rough out the handle shape. Make a copy of the handle section of the plan and stick it to the top side of the wood with double-sided sticky tape, or two blobs of hot glue. This will act as a guide for removing unwanted wood. If you have a band-saw, it's the perfect tool for the job, but it could also be done with a jigsaw or coping saw. It can help – particularly with non-square materials – if you hot-glue the handle to a piece of thin 'sacrificial' sheet material, e.g. 3 mm MDF or ply. Aim to cut away all excess material to within 1–2 mm of the pattern edge. The more accurately you can do this, the less sanding you'll have to do later. Repeat the process for the side profile. The knife in this example is symmetrical, so has the same profile for both top and side view. Other designs don't, so use whatever is appropriate for your chosen design.

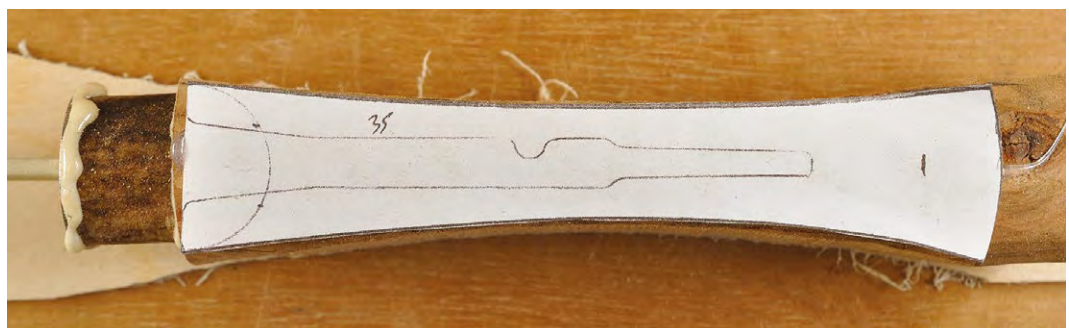

Right ♦
A scrap of sacrificial 3 mm ply and hot glue hold a 'round' wood blank in position for cutting



SHAPING UP

Now it's time to finalise the shape of the handle. You can take larger chunks off with a sharp knife or chisel, but you have a much better degree of control with sanding. You need to find the right balance between speed and accuracy, which you can only learn by 'doing'. If you take your time, you will end up with a nice result. Shaping of the handle usually takes a couple of hours and is great 'thinking time'.

Put masking tape round the blade to protect both it and yourself. Clamp the blade and use a coarse grit, (40–60) on a power sander or detail sander, to blend

Make the handle super-smooth by hand sanding with 'wet 'n' dry' abrasive paper used dry. Progress up through grades 400, 600, 800, 1200, 1500, 2000 and you'll end up with a wonderful surface

the handle and antler to the shape of the coin bolster. Try not to let the sander remain in one place for long. Keep it moving backwards and forwards and change the angle. Blend the whole handle into the desired shape. When satisfied, use a finer grade abrasive paper (120–240) to smooth the handle.

Then make the handle super-smooth by hand sanding with 'wet 'n' dry' abrasive paper, used dry. Progress up through grades 400, 600, 800, 1200, 1500, 2000 and you'll end up with a wonderful surface. It takes time and patience, but it's truly worth it. From band-saw to 'finally smooth' usually takes two to three hours. But it's your knife. It's totally up to you how far you take it.

I'LL GET MY COAT

Now it's time to finish the handle with a protective coating. You can use wax polish, varnish, or one of the various oils available for wood finishing. In this example, Birchwood Casey's Tru-Oil is used. Four or five coats of this boiled linseed oil blend, with two hours between coats, brings out the natural beauty of the wood and the antler 'ivory' with a lustrous shine.

Then, all that's left to do is sharpen the knife to your own precise requirements. Most knife blades are sold 'usably sharp', but if you want to carve or shave with it, it may need some further work with oil stones, whetstones, or waterstones.

It takes a little patience and time to handle a knife this way, but you end up with something unique, personal, and beautiful. It's a great project for a weekend make. Happy knife-making. □

Above □ Part-way through sanding, the antler still shows some of its exterior

Below ♦ The handle hole should be generously sufficient for the tang and glue, leaving some flexibility in alignment



Besiege a castle with a trebuchet

TUTORIAL

Build a three-foot trebuchet

Makers – dust off your drill and prepare for glory!



Everyone knows what a catapult is. It throws stones and flaming projectiles at castles. It is famous – and rightfully so. But for some reason the trebuchet, which is a different type of siege engine, is not so famous. Yet, it is much more powerful than a catapult. It can launch heavier projectiles longer distances and is much easier to build! Rather than using complicated twisted ropes, a trebuchet uses the power of gravity to launch its projectile. In this tutorial you will learn how to build one that is 3ft (91 cm) tall and capable of launching projectiles at some pretty amazing distances.

Everything in this build is very common except for two small parts: a welded ring and several push-on external retaining rings. However, even these are easy to get and you can even improvise something as a replacement for them. We will take a closer look at them as they are needed in the build. And we will offer you possible alternatives.

This build is well within reach of a person who has minimal DIY skills. Can you use a drill and a hammer? Then in about six hours you will be launching tennis balls at your neighbour's house. But don't do that! Your neighbour might also read this tutorial and build one for themselves. Then you will have a right proper medieval warfare campaign right in your own back yard...

We purchased all the parts at a local (US) home improvement store. The wood cost \$44.62; the various other parts, paracord, steel bar, nails, screws and everything else cost \$28.26, for a total of \$72.88. You can reduce this price significantly if you have some of the materials on-hand. A good example is the screws: if you buy full boxes, you'll

have plenty for future projects. If you already have an assortment of nails and screws, you can reduce the cost of this project by \$15.

A trebuchet works the same way as a see-saw. If you sit down very quickly on one end of a see-saw, the other end pops up equally quickly. And the heavier the weight, the faster the pop-up. If you shift the fulcrum closer to where you push, the other end will travel even faster. A trebuchet capitalises on this. It uses the principle of a fulcrum and the power of gravity to launch projectiles rapidly into the air.

We will build this trebuchet in four major parts: the base, the swing arm, the ballast box, and the string/pouch assembly.

PART 1 THE BASE OF THE TREBUCHET

Measure and cut the 1 × 4s to form a base for the trebuchet. It is 48" (122 cm) in length and 12" (30 cm) wide. Notice that the 1 × 4s are on their sides. Screw them all together using #8 wood screws that are 2" (51 mm) long. Cut one of the sheets of plywood in half and nail or screw these halves to the base. →



Above ♦
The swing arm is mounted onto the trebuchet

Left ♦
Creating a sturdy base for the trebuchet is important. It keeps it stable during the strong centrifugal force that shoots the projectile



Will Kalif

🐦 @willkalif

Will Kalif is an amateur siege engineer who has built all types of siege engines, ranging from 1ft (30 cm) miniatures to 10ft (3 m) behemoths. He is the webmaster and owner of the website StormTheCastle.com

YOU'LL NEED

- ♦ 2 × sheets of plywood 2' × 2' (61 × 61 cm), 3/16" thick
- ♦ 12' (366 cm) pine wood 1" × 4" (25 × 101 mm)
- ♦ 12' (366 cm) pine wood 1" × 3" (25 × 76 mm)
- ♦ 12' (366 cm) pine wood 1" × 2" (25 × 51 mm)
- ♦ 1 × length of steel rod 3/8" (9.5 mm) thick × 36" (91 cm)
- ♦ 8" × 16" (20 × 41 cm) piece of leather or cloth
- ♦ 8' (2.4 m) paracord
- ♦ 1 × 6d (51 mm) nail
- ♦ 1 × 1" (25 mm) eyebolt
- ♦ **Ballast**
Anything heavy, such as stones, sand or weights
- ♦ 1 × 3/8" (22 mm) **Welded ring** (a keyring will work as a substitute)
- ♦ 8 × 3/8" (9.5 mm) **push-on external retaining rings** (optional)



TUTORIAL

TOOLS

- ◆ **Electric drill**
- ◆ **1/8" (3 mm) drill bit for pilot holes**
- ◆ **3/8" (9.5 mm) drill bit** (match this drill bit size to the diameter of your steel rod)
- ◆ **Screwdriver or screwdriver bit for drill**
- ◆ **Hand saw**
- ◆ **Hack saw**
- ◆ **Hammer**
- ◆ **Measuring tape**
- ◆ **30/60 triangle** (optional)

It is important to have this smooth and flat surface because the sling will ride on top of this when the trebuchet fires.

Measure and cut two lengths of 1 × 3 to 30" (76 cm) in length and screw them vertically to the base, one on each side and each right in the middle of the base. Drill a 3/8" (9.5 mm) hole 1 inch (25 mm) from the top of each of these. Cut your steel bar to 14" (35.5 cm) and insert it through these two holes right across the trebuchet. This is the axle (fulcrum) for the swing arm. These vertical supports are not strong enough to sustain repeated use of the trebuchet because there is significant centrifugal force applied in a front-to-back direction. We brace against this force by adding four support pieces that are at an angle to the uprights. Measure and cut four of your 1 × 2s to 30" (76 cm) then cut an angle on the ends of each. All four pieces are identical and each piece has a 30-degree angle cut on one end and a 60-degree angle cut on the other end. Screw these to the uprights.

PART 2 THE SWING ARM

To make the swing arm, cut one of your 1 × 3s to a length of 52 1/4" (133 cm). At one end of it, drill a 3/8" (9.5 mm) hole 1 inch (25 mm) from the end. This hole is for the ballast basket we will make. Drill a

KEEP THE BUILD CLEAN

Always drill pilot holes before putting in screws. This will ensure that the screw goes into the wood straight, and will help prevent any cracking or splitting of the wood. Use a 1/8" (3 mm) drill bit for pilot holes.

second hole 12" (30 cm) from that same end of the swing arm. This hole is for the fulcrum. Mount the swing arm onto the structure of the trebuchet using the fulcrum hole and the steel rod.

PART 3 THE BALLAST BOX

Our final piece of wood is the second piece of plywood. Measure out a box to make. The box is made up of five pieces and it has a 3/8" (9.5 mm) hole 1 inch (25 mm) from the top. When making this box you should be aware that it needs to swing freely without hitting anything on the trebuchet, including the swing arm and the base of the trebuchet. Attach it to the swing arm hole one inch from the end. Cut a piece of your 3/8" (9.5 mm) steel bar for this.

The house shaped ballast box is 10" (25 cm) wide and 12" (30 cm) tall. You can trim the top 4" (10 cm) of it to form the triangular roof of the house shape. Measure and cut two of these. The sides of the box hold those house shapes 6" (15 cm) apart. You have a lot of freedom in making a ballast box. Just be sure it doesn't rub on any part of the trebuchet base or swing arm throughout its full swinging motion.

PART 4 THE STRING AND SLING

This is the most important part of the build, but also the easiest. The sling itself is a piece of cloth or soft leather 8" × 16" (20 × 41 cm), folded in half. You can trim the cloth of the sling so the top of each end is triangular, similar to the house shape of the ballast box, but triangular-shaped on both ends of it. Cut two lengths of paracord each to 48" (122 cm) and tie them to the tips of the sling. Then attach one to an eyehook at the end of the swing arm. And on the other length of paracord, attach a metal ring. We used something called a welded ring, bought at a hardware store for about a dollar. You can use a keyring for this. It is important to use a metal ring that will easily slide over the nail without catching or getting stuck.

In the final picture you can see a nail sticking out of the end of the swing arm. This nail is critical. Use

FINE TUNING

Want to improve the look of your trebuchet? There are a few things you can do, including tapering down the swing arm so it's thinner at the string/pouch end. This will also increase the efficiency. We tapered the swing arm down to a width of 1 1/2" (38 mm) at the end. You can also paint or stain your trebuchet any colour or theme you desire.



QUICK TIP

The plywood is thin. Use 1" (25 mm) finish nails for assembly of the ballast box.

Above

The ballast box should be sturdy and strong in order to hold the weight of the ballast

THE GOLDEN RATIO

Want to build a larger, or smaller, trebuchet? The most important thing to consider is the ratio of the swing arm on both sides of the fulcrum. Keep this at 3.75 to 1 and you will get maximum efficiency. The length on the sling side is the 3.75 and the length on the side of the ballast is the 1.

a 6d (51 mm) nail and file the head off of it. Hammer it into the end of the trebuchet so it sticks out.

Locking things in place

For this project we use two lengths of $\frac{3}{8}$ " (9.5mm) steel rod. You can just feed these lengths through the holes and the trebuchet will work. But with repeated use, things will start to slip. To prevent this you should secure the parts in place on the rod with washers and some kind of locking rings. The easiest and cheapest way to do this is with push-on external retaining rings. They are simple little metal rings that you push by hand right over the steel bar. They have small internal teeth on them and stay locked onto the bar wherever you place them. We purchased some at a hardware store for 40 cents each.

FIRING THE TREBUCHET

Fill the ballast box with weight, put a projectile in the sling and pull the swing arm down. Place the ring over the release pin. Inspect everything to ensure the paracord is laid out straight on the base of the trebuchet and not twisted. Fire it by letting go of the swing arm. As the swing arm moves in its arc, it pulls both strings evenly, bringing the pouch along the base of the trebuchet. At a point in its swing near vertical, the ring will slide right off the nail/pin. This opens the sling and releases the projectile.

This trebuchet is a simple machine with only two moving parts. If you have trouble launching projectiles, here are some things to look for:

First, you should look to the ballast basket. Is it rubbing or hitting on something? Does it not allow for smooth motion of the swing arm? Adjust it, resize it, or trim it as needed. If your trebuchet fires its projectile straight up or backwards, your nail needs to lean more forward. If your trebuchet fires its projectile at the ground or not too far then your nail needs to lean less to the front. But just make these adjustments to the nail very slightly – and test it.

MORE POWER!

One of the best things you can do to make your trebuchet even more powerful is to add a bearing



around the steel rod at the fulcrum of the swing arm. This will take a lot of the friction out of the motion.

How heavy your ballast is depends on your trebuchet. Start with 10 lb (4.5 kg) of weight and give it a try, then add more weight. It will get to a point where adding more weight will not throw your projectile further. Want to control the distance it shoots? You can do this by controlling the weight in the ballast box. An easy thing to do is pre-make bags of sand and label them. Then you can just add or remove bags of sand to the ballast box, keeping track of the weight inside and the distance it throws. □

Above

This photo shows you the shape of the sling, where to put the eyebolt, how to install the pin, and how to tie it all together with the two pieces of paracord

Below

The completed trebuchet as built in this tutorial. Be careful where you launch your projectiles!



INSPIRATION

HACK | MAKE | BUILD | CREATE

Get inspiration for more projects with these guides to using household objects, plus expert making tutorials and introductions to traditional craft techniques

Top Projects – Showcase

Nixie clock

PG
130



PG
114

DUCT TAPE

No toolbox should be without this ubiquitous fix-all



PG
118

MATCH STICKS

Fun projects to make with a box of matchsticks

PG
122

HOT GLUE

Bind all kinds of projects with this versatile fastener

PG
126

PAPER CLIPS

They can do far more than hold pieces of paper together



Top Projects – Showcase

PG
144

Trash instruments



PG
132

PI READING GLASSES

Smart specs that can read text out loud

PG
136

CHICKEN COOP DOOR

A light-sensing smart door for farmyard animals

PG
140

ROCKET STRANDBEEST

This amazing walking robot launches rockets

PG
146

ROBOT ORCHESTRA

Almost anything can become a robotic instrument

PG
150

GLASS BLOWING

Learn how to make a multicoloured glass bauble

PG
156

BELT MAKING

Keeping our trousers up the hacker way

Top Projects – Showcase

Bike trailer

PG
162





No toolbox should be without this ubiquitous fix-all



Despite the fact that duct tape, in its current incarnation, wasn't even invented until the mid-20th century, it's hard to imagine what the world did without it.

The winning combination of water-resistant layer plus fabric plus adhesive makes it a wonder material, equally capable of repair and creation.

In the early years, its predecessor, adhesive-backed duck cotton fabric, was used primarily for medical purposes. As the story goes, in 1943, during the tail end of World War II, a woman named Vesta Stoudt was working at the Green River Ordnance Plant in Illinois, inspecting and packaging rifle grenades. A mother of two Navy soldiers, she worried that the thin paper tape and waterproofing wax used to seal the ammo boxes was too difficult and potentially time-consuming to open in the field. She suggested creating and using a water-resistant adhesive-backed cloth tape, but when her words fell on the deaf ears of her supervisors, she handwrote a letter to then-President Franklin D Roosevelt, whose own sons were also fighting in the war.

Much to her delight and relief, her suggestion was received and deemed important enough by the American leader for the government to call in the Johnson & Johnson company, known for its fabric medical tapes, charging them with inventing what was to be the first duck tape, named for its ability to repel

water like a duck and for the fact that it was made from duck cotton. It was originally army green. Quickly recognised for its versatility, it also became dubbed '100 mile an hour' tape because it could be used on virtually anything, including vehicles, aircraft, and guns, not to mention its emergency medical usages in the field. So in this case, the mother of invention was actually somebody's mother.

After the war, the sticky wonder was promoted for civilian purposes, notably as a way to hold ventilation ducts together. It was then offered in silver to match the ducts and referred to as duct tape. Ironically, the standard variety has since been deemed unsafe for use on HVAC ducts because of its flammability and toxicity when heated, but it has found plenty of uses the originators could never have imagined, from building kayaks and clothing to repairing spacecraft. As the old saying goes, if you can't fix it with duct tape, you haven't used enough. But before we get to that, let's unpack this magic tape and take a look at what makes it work.

Sealing the duct tape sandwich is a top coat of low-density polyethylene (LDPE), the most common plastic on earth, which provides its resistance to water, abrasion, and friction, all while staying flexible. Below that, duct tape gets its superior tensile strength from its fabric mesh foundation. The tighter the weave and higher the thread count of the mesh, the stronger the



Goli Mohammadi

[@snowgoli](https://twitter.com/snowgoli)

Goli Mohammadi is a word nerd, highlighter of makers, and lover of mountains. When she's not staring at glowing screens, she's romping around nature. Find her at snowgoli.com

GET THE GRADE

With many grades to choose from, how do you pick the right duct tape for your project? Even though there are lots of classifications, such as 'all purpose' and 'advanced strength', each manufacturer has its own way of defining these. Basically, you want to look at these four specs.

THICKNESS

Generally, duct tapes range from 3 mils to 17 mils. Thicker tapes are naturally stronger but also less flexible, which affects how they wrap around objects. A good general-use tape should be about 11 mils. You can also layer thinner tapes to increase their strength.

ADHESIVE

Quality duct tapes all have adhesive made of natural rubber. The more natural rubber, the better the performance of the tape. There's also the 'hot-melt' adhesive variety, but these tend to be less reliable in extreme temperatures and are weaker.

THREADS

Looking at the threads of the cloth grid (or scrim) can give you an idea of the tape's quality. Threads that run the length of the tape lend strength, while threads that run across show how easily it is to tear by hand. So, the closer those threads, the stronger it is and the easier to tear by hand.

MANUFACTURING TECHNIQUE

Duct tapes are either made by co-extrusion or lamination, with the former being far superior. In co-extrusion, the scrim is melted into backing, forming a cohesive whole, before the adhesive is added. With lamination, all three layers are pressed together, causing a risk of bubbles and weakness.

Price can also be a good indicator of how high-quality the tape is, and consequently, how long it will last and keep its structural integrity. You really do get what you pay for here. There are also classifications such as consumer, industrial, and military grades. Industrial is the variety that professionals use for actual HVAC ducts, and is more waterproof, heat-resistant, long-lasting, and adherent to metals than the consumer variety.

Military grade then ups the ante to the next level of strength and durability, often reflected in the price.



tape and the higher the rip strength. No longer restricted to just cotton, thread options now include nylon, rayon, and polyester. Lastly, the adhesive is applied as the base layer, unique in that it's made with rubber compounds and caked on to the mesh in a much thicker coat than used on most other tapes.

Duct tapes are classified in grades, determined by the type of adhesive and strength of the fabric. An

Above  Duct tape, shown here attached to some reinforced concrete rebar, is ridiculously versatile



DUCT TAPES ARE CLASSIFIED IN GRADES, DETERMINED BY THE TYPE OF ADHESIVE AND STRENGTH OF THE FABRIC



inexpensive, standard duct tape may have a 9 kg (20 lb) rip strength, while military grade could easily be twice that. The varieties and grades are as varied as the uses. There's even a nuclear-grade duct tape that's certified for low leachable halogens and sulphur, can withstand temps up to 93°C (200°F), is UV-resistant for up to a year, and doesn't leave a residue when removed.

Worth mentioning is the disambiguation between duct tape and gaffer tape. Though the words are commonly used interchangeably, these are two different products with key differences. Typically used by theatre, film, and photography professionals, gaffer tape (named for the chief electrician on television and motion picture crews) is matte to deter light reflection, has a cloth top layer, and employs a heat-resistant adhesive that is easily removed without leaving stickiness. →

BOTS + BOTS OF TAPE

Nelson Yepez always wanted to make a hydraulic robot arm, but most of the projects he saw online required a way to cut wood or metal. Having neither, he decided to go super low-tech by using reclaimed pizza boxes reinforced with duct tape, giving the bot a “cool metal-like look” as well as added durability. Yepez’s cutting template makes the build a breeze, and if the cardboard you use is on the thin side, you can easily reinforce with another layer or two of duct tape. The hydraulic system is cleverly made using drug store oral syringes, clear tubing filled with water, and a few machine screws. The hardest part might be filling the tubes with water. Each push of a syringe moves a different part of the bot arm. This project is an ideal low-cost build for teaching the basics of hydraulics and is sure to wow at any science fair. Who says robotic arms need to be high-tech? □

Project Maker
NELSON YEPEZ

Build Your Own
hsmag.cc/EqnXPe

Right □
When you don't have metal, fake it with duct tape

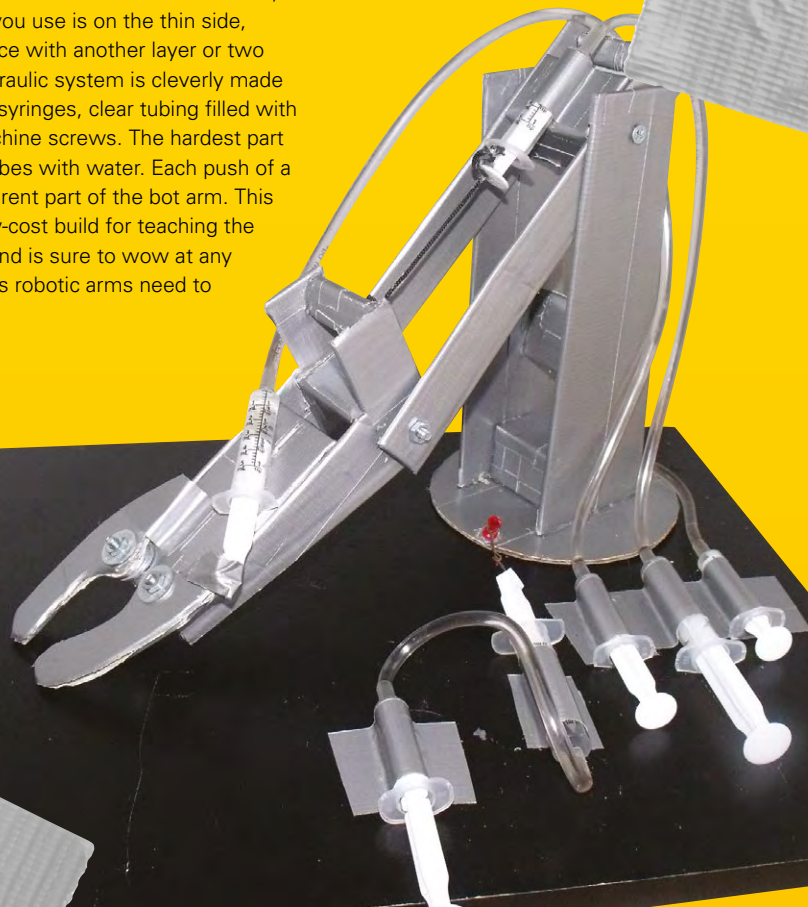

TOTING TOOLS IN STYLE

I

nspired by Craftsman and AWG tool bags, Tristan Laughlin designed this duct tape version with many of the same useful features. The only ingredient is cardboard, which makes this project so inexpensive that you can save your money for the tools to fill it. This handy little carrier is water-resistant, full of useful side pockets, and is a prime example of how strong cardboard and duct tape can be when they join forces. ▣

Project Maker

**TRISTAN
LAUGHLIN**

Build Your Own
hsmag.cc/iNKdMj

Right ▣

Like getting soup in a bread bowl, the container may end up being as useful as the contents



SPACE TAPE

W

e'd be remiss to not take a moment to appreciate how duct tape has been aboard every major spacecraft mission in recent history. It's not only the fastest way to keep floating items secure in zero gravity, but it's saved missions and lives in a pinch. When a fender on Apollo 17's Lunar Roving Vehicle accidentally got caught on a hammer in the shin pocket of astronaut Gene Cernan's spacesuit, half of it ripped off. Normally, a broken fender would be no big deal, but on the moon's surface, the rover was kicking up plumes of dark, abrasive moon dust. Crew members used duct tape, lunar maps, and clamps from the optical alignment telescope lamp to create a makeshift fender. Apollo 13 astronauts also used it to MacGyver a carbon dioxide filter modification. When an explosion occurred on the Apollo 13 service module, all three crew members had to transfer to the lunar module, which was only designed to contain two astronauts for 36 hours. With carbon dioxide



Left ▣

Duct tape on this makeshift fender repair seems somehow right at home on the moon

Project Maker
NASA

Build Your Own
hsmag.cc/FtkRBo

hsmag.cc/aCcOmX

levels rising at an alarming rate, they had to find a way to make the square filters they had work with the lunar module's round holes. Using found objects and duct tape, they were able to modify and survive. ▣

MATCH STICKS



Mayank Sharma

@geekybodhi

Mayank is a Padawan maker with an irrational fear of drills. He likes to replicate electronic builds, and gets a kick out of hacking everyday objects creatively

For something that's essentially made up of just two components, a matchstick is an extremely dexterous tool

History would have us believe that the ability to start a fire has a direct correlation with the growth of human civilisation. It was our ancestors' desire to control fire that distinguished them from animals. While we gained control over fire more than a million years ago, matchsticks are a fairly recent invention. Some of the earliest examples of matches are the Chinese fire sticks from 577 CE that were used by the women of a town to ward off invaders.

Over the years intrepid alchemists have generated heat and fire with many chemical reactions. In 1680, Sir Robert Boyle produced a flame by scratching a splinter of sulphur-coated wood on a piece of paper coated with phosphorus. Jean Chancel, the assistant of famous French chemist Louis Jacques Thénard, gave us the first modern self-igniting match in 1805. The head of this match was made from a mixture of potassium chlorate, sulphur, sugar, and rubber, and the user

ignited the match by dipping it into a small bottle filled with sulphuric acid. The match didn't get much attention because of the dangerous and expensive mix of ingredients.

The first friction matches came along in 1826, when John Walker combined a paste of sulphur with gum, potassium chlorate, sugar, and antimony trisulphide, and ignited it by drawing the match between a fold of sandpaper. His matches however were considered too dangerous, and were even banned in France and Germany. Charles Sauria then reformulated the match using white phosphorus, which turned out to be dangerous in other ways.

The calls for banning white phosphorus matches led to safety matches that were devised by two Swedes. First, Gustaf Erik Pasch in 1844 proposed placing some of the match's combustion ingredients on a separate striking surface, rather than incorporating them all into the match head, as a precaution against accidental ignition. This idea, along with the discovery of the non-toxic red phosphorus, led J. E. Lundström to introduce safety matches in 1855. Although safety matches posed less of a hazard, many people still preferred the convenience of strike-anywhere matches, and both types are still used today.

Modern matches are manufactured in several stages. In the case of wooden-stick matches, the matchsticks are first cut and soaked in a vat filled with a dilute solution of ammonium phosphate. They are then dried and inserted into holes in a long perforated belt, which dips them into several chemical tanks before they are dried and packaged in boxes.



MATCHSTICK ROCKETS



Project Maker

**WAREN
GONZAGA**

Project Link

hsmag.cc/PTQtqX

Did you know?

The hobby of collecting match-related items like matchboxes, matchbox labels, and such is known as phillumeny.

ALERT!

Matches are flammable, and some of these projects shoot flaming sticks. Make sure there's nothing flammable nearby and bear in mind that they may not end up where you expect.

Ever since he was in middle school, **Warren Gonzaga** dreamt of working for NASA and building rockets. Since he couldn't find a hobby class to pursue his interest in his city in the Philippines, he decided to enrol in Mike Warren's Rocket Class on Instructables.com (hsmag.cc/ZbtTMu). Warren wanted to build a solid propellant rocket but couldn't find a shop from where he could source the materials. "Also, I am not aware of any law regarding making and launching rockets," he adds. He remembered seeing an article from NASA on matchstick rockets some eight years earlier. Since that article lacked specifications, Warren decided to construct his rocket

Above ♦ Warren is a true rocketeer, and says that he even enjoys the "smoke from the failed rocket launch attempts"

by experimentation. His Instructables page has details on the science involved, along with lots of illustrated build information to help anyone replicate the project. The construction involves wrapping a piece of aluminium foil around the strikeable tip of the matchstick. Pinch the foil at the top to make sure the exhaust is directed towards the bottom to achieve lift-off. Warren experimented with several designs and shares details about the failed ones, along with the successful ones. □

MATCHSTICK CRAFTS

Project Maker

CORDELL VON MALEGOWSKI

Project Link

hsmag.cc/vLrLnH

A few years after a classmate bought a cube made of matches for one of the projects in Cordell's high school design class, he decided to make one of his own. "After some trial and error I was

able to make it and then I made a video on how I made it. As that video became popular, I made a few more matchstick creation videos, with one of them becoming my most viewed video," shares Cordell. All his videos detail each and every step, with clear and detailed annotations. Unlike the majority of matchbox crafts, most of Cordell's are put together without

glue and can be easily duplicated with a little bit of patience and lots of matchsticks: "The motivation behind my matchstick creations is to make something impressive out of what is a seemingly simple object. It is also to inspire others by showing what can be achieved with some time and patience."

Like the Buddhist monks who destroy a mandala on completion, Cordell lights up his creations once they're done: "The reason I burn them after is mostly for the entertainment value. As they are made from matches, it's what most people would expect and want me to do." ▣



Right ▣

The matchstick creations serve no practical purpose but, as Cordell suggests, they do make excellent gifts

MATCHSTICK GUN

If you've ever had the desire to rain flaming arrows on your enemies, follow Grant's project to unleash your medieval warrior. He converts a regular clothes peg into a piece of desktop weaponry that can shoot matchstick arrows over 20 feet. "When I made that project, I had a small son who instantly fell in love with it, and he had me make a few more so we could run around the house having matchstick wars. It was a great way to bond, father and son," shares Grant.

To make the gun, simply remove the spring from the clothes peg and place them back to back. Then carve out the channels for the arrows with a utility knife, and cut a small notch to hold the spring. Then, glue the pieces back together and attach the spring. Grant's Instructable has detailed illustrations that'll help you easily repurpose the clothes peg. [□](#)



Project Maker

GRANT THOMPSON

Project Link
hsmag.cc/YVMpQD

Above [□](#)

Let's be clear, shooting pointy or flaming projectiles is dangerous. Be sensible and safe if you decide to recreate this project

MATCHSTICK PUZZLES

Unarguably, the most popular non-incendiary use of matchsticks is to build puzzles. Matchstick puzzles became popular in the 19th century, and are perhaps the earliest examples of board games. Dawie van Heerden from Cape Town, South Africa has always been intrigued by "these little sticks with their rounded heads". He has been collating matchstick puzzles on his blog, that's ranked among the Top 100 Puzzle Blogs on the web. He has been posting puzzles since 2011, and the blog currently has over 500 puzzles. Each puzzle post has a matchstick illustration, along with a textual

Project Maker

DAWIE VAN HEERDEN

Project Link
hsmag.cc/YBcMrK

challenge and is tagged with one of the four difficulty levels: easy, medium, hard and extreme. Thanks to the images, you can replicate the puzzles offline with real matchsticks with little trouble. Each post also has an illustrated answer, and you can browse the blog without accidentally revealing the solutions. [□](#)

85. Chair Fell Over

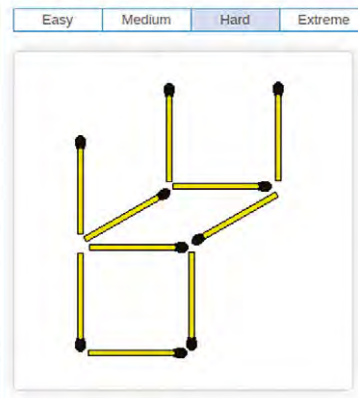

Above [□](#)

Dawie is the creator of the Quickstick board game ([quickstick.info](#)) which challenges you to solve digital numerical puzzles



Bind all kinds of projects with this versatile fastener



Mayank Sharma

[@geekybodhi](#)

Mayank is a Padawan maker with an irrational fear of drills. He likes to replicate electronics builds and gets a kick out of hacking everyday objects creatively

A

glue gun is one of those essential bits of kit that all makers should have safely stashed away in their toolbox.

The active ingredient in this all-purpose device is hot melt adhesive (HMA), more commonly

known as hot glue. Initially fabricated to bond shoe soles, HMA is now the go-to glue for most crafters and is useful in a number of different hobbies. All kinds of makers use hot glue as a quick-assembly prototyping adhesive. You can use it to quickly glue up the test parts for your build, have them strong enough to hold together to make sure that everything fits and works, but it's all still weak enough that it can be easily taken apart again to make changes before final assembly. And while its primary purpose is to glue, if you look at it as a molten plastic dispenser, you start to see a lot more uses for it, in moulding and casting, sealing, and many other applications.

Hot glue is most commonly available as solid cylindrical sticks. They were introduced in the 1940s as an improvement to water-based adhesives that were prone to weakening when exposed to humidity. HMAs are applied to a

material in the molten (liquid) state by glue guns that have a heating element to melt the plastic glue. The glue sticks are pushed through a cavity at the end of the device either manually or by pulling a trigger, depending on the gun. When a second material is brought into contact, the glue cools down and solidifies very quickly.

Hot melt adhesives contain no water and no solvents of any kind. They are designed to set and form a bond by the loss of heat which translates into a very fast setting speed. HMAs can bond both similar and dissimilar materials. They vary in width and length and are generally made up of waxes, resins, and a variation of thermoplastic polymers. The polymers give them strength, the resins are responsible mainly for the adhesion, and the wax helps thin the adhesive for easier application. The chemical composition of HMAs varies depending on their use. The strength of the bond depends on several factors such as the temperature at which they are applied – a hotter adhesive takes longer to set and a cold one sets before the materials are bonded. Typically HMAs are waterproof and can withstand chemical treatments, but they are usually not suitable in high-temperature applications.

HOT GLUE CASTING

While it's a very good adhesive, hot glue can also be used for casting objects.

For a simple shape, you just make a plaster mould of the object you want to duplicate and then squirt hot glue into the negative space once the mould has hardened. Siddharth Jain applied this technique to create a hot glue cast of the Instructables Robot (that appears in the website's logo) which can double up as a geeky night lamp. He used cardboard to create the mould for the robot's head, a bowl for its belly, baking foil wrapped over a thick marker pen to mould its legs, and epoxy putty for its hands. He then filled the moulds with hot glue and inserted a couple of LEDs in the head and the legs as the glue cooled. Siddharth has shared assembly details and other nuances, with pictures of every step to make it easier to replicate his build. □

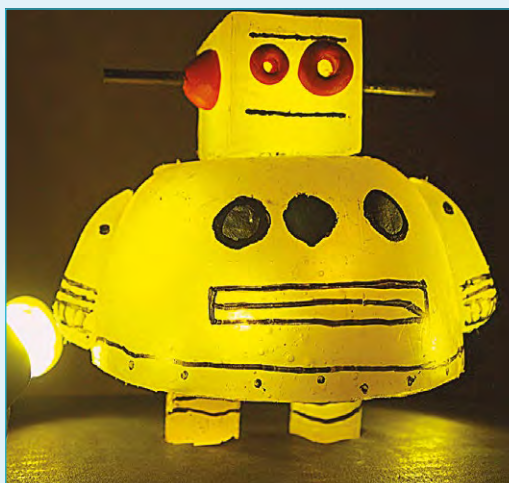

Project Maker

**SIDDHARTH
JAIN**

Project Link

hsmag.cc/KXSCoh

Left ◀

It took eight 11-inch glue sticks to cast the robot: two each for the head and limbs, the rest for the body

Credit

instructables.com

GLUE STICK ROBOT

Project Maker

**PAVEL
MIHAYLOV**

Project Link

hsmag.cc/mHYtGI

Below ▶

The friction-inducing spikes at the tail complement the ones at the front and give it a personality

Credit

instructables.com

If you've handled hot glue sticks, you'll have noticed their spring-like nature when bent.

Pavel Mihaylov, an engineering student in the University of Edinburgh, decided to exploit this behaviour to make a neat little robotic toy that propels itself using glue sticks. Pavel's robot has a bunch of hot glue sticks between the front and the tail, along with a couple of strings. He uses Arduino-controlled servo motor actuators to pull the strings from the tail to the front, which also bends the glue sticks. The actuator then lets go and the bent glue sticks straighten and push the robot's front forward. Explaining the physics behind the movement, Pavel says the robot's tail has very little friction with the ground on one end and very high friction at the other end, which keeps it stuck to the ground as the glue sticks unfold. Pavel has also shared the simple code for controlling the servo. □

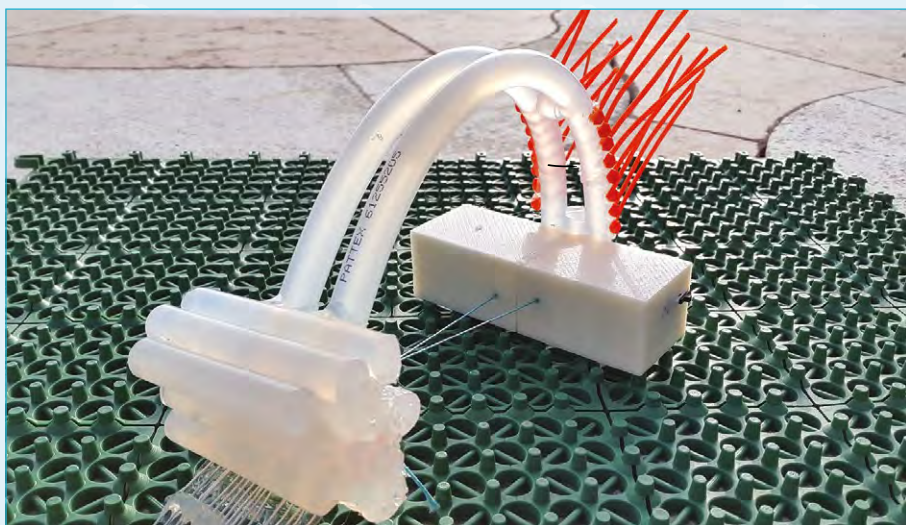

ROTATING PHOTOGRAPHY STAND

Project Maker
DIYATHOME

Project Link
hsmag.cc/aZZFpQ

The creative individual behind the DIYatHOME YouTube channel, who prefers to remain anonymous, hot glues some easily accessible knick-knacks and puts them to innovative uses.

Being a macro photographer, one of my favourite is the rotating photography stand that you can put together in a matter of minutes. Just hot glue the cap of a pen to a ball bearing and then glue a strip of cardboard around it and stick them to another piece of round cardboard. Next, splice a small DC motor along with an on/off switch to a USB cable.

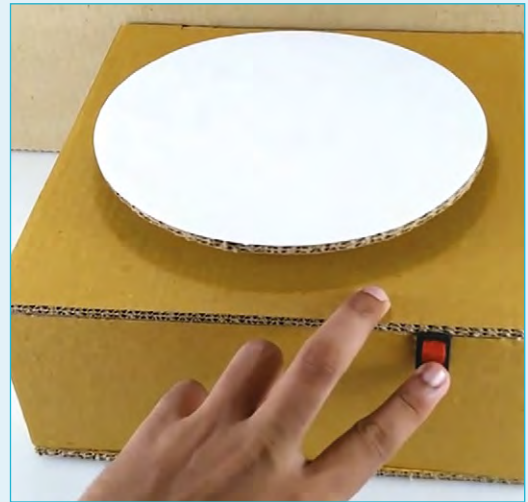

Above ↕
Head to DIYatHOME's YouTube channel (hsmag.cc/bhfxmp) for more fun projects built with cardboard

Credit
youtube.com

Finally, put them together, while making sure the shaft of the motor is in contact with the circular cardboard. DIYatHOME's instructables page has brief but well illustrated step-by-step instructions to better understand the process. □

DIY COLOUR HOT GLUE STICK

Project Maker
KEN

Project Link
hsmag.cc/tojaac

Ken grew tired of the clear-coloured glue sticks. Instead of shelling out the premium for buying coloured hot glue sticks, he decided to make some of his own. Ken's written up the procedure on his blog and also made a video of the process after popular demand. The process is simple and wouldn't take much time, but is labour-intensive and not suitable for children because of the temperatures and smells involved. The key to this process is the Reynolds parchment paper, which is coated on both sides with silicone. Hot glue won't stick to parchment paper, which makes it an ideal material for a mould when wrapped inside a brass tube. Ken then heats up some glue sticks with a Crayola crayon and pours the mixture inside the mould that then solidifies in about half an hour. In the write-up, Ken has also shared some tips to ease the pouring process, including using a silicone funnel or one created with cardboard lined up with parchment paper. □

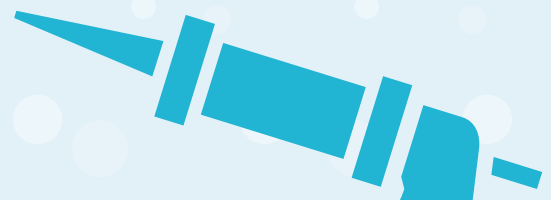

Above ↕
Ken says the wax from the crayon doesn't really change the bond strength of the hot glue

Credit
observationsblog.com

HOT GLUE HACKS

**A WATERTIGHT AND AIRTIGHT SEAL**

Hot glue is a handy little fix to seal small holes and will also work under water. Remember however that it won't take much abuse, so use it with caution.

**COVER EXPOSED WIRES**

Mixing hot glue and electronics isn't usually a good idea since electronics produce heat, but you can use hot glue to cover wires peeling out of earphones and USB cables.

**GIVE RUGS A NON-SLIP GRIP**

Rugs are pretty slippery, especially over smooth tiled or polished floors. Apply dollops of hot glue to the bottom to increase the friction and make them less slippery.

**ADD TEXTURE**

Create a design with hot glue on any surface—canvas, eggs, wood, bottles, vases, etc. Once dry, paint over it for more personality.

**HANG LIGHTS**

It can be tricky to hang lights on a brick wall. Save time by applying a small amount of glue to the wall and then paste the lights. Reheat the glue with a lighter to take them off.

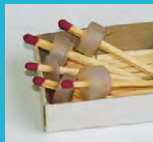
**HOT GLUE MATCHSTICKS**

Poke a hole and pierce pieces of hot glue near the striking end of the match. In an emergency, light the match, let the flame heat the glue, and then spread the glue.

**TEMPORARY SOLES**

If you have worn out the soles of those comfortable pair of shoes, make them grip again with a coat of hot glue.

**BASKET FOR TRINKETS**

Use a brush to coat any kind of oil on the outside of a glass bowl. Then draw lines on it in the form of a spider web and peel it off once it dries.

GLUE GUN SANDALS

When Brooke's dog chewed up one of her slippers, like any good maker she decided to fabricate a set of her own.

She recalled seeing a video of a hot glue DIY for a pair of flip-flops and decided to build upon the process. Brooke's process is fairly straightforward and easy to replicate. She makes a stencil out of cardboard, then places a sheet of parchment paper over it and applies a layer of hot glue. A similar process is used to fabricate the bands. She then trims the base to make them prettier and glues them together. Brooke writes that her hot glue sandals will not let moisture, rocks, and dirt come through and the noise they make initially will eventually die down. The first time she attempted the sandals though she used aluminium foil instead of parchment paper: "Once I glued all the parts and let them dry, I attached the pieces of the sandals together with the aluminium still on, so that I could peel it off as a final reveal. When I finished, I gathered everyone around to watch me peel off the foil, except that it didn't come off, and there was no reveal. My family had a great time laughing about my silver shoes for the next few weeks." □

Project Maker
BROOKE

Project Link
hsmag.cc/FqKmtl

Below ■
Make sure you don't apply a lot of glue to one spot – it'll layer up and feel uncomfortable

Credit
instructables.com



PAPER CLIPS



Hold, build, and break out things with this inexpensive ubiquitous tool



Mayank Sharma

[@geekybodhi](#)

Mayank is a Padawan maker with an irrational fear of drills. He likes to replicate electronics builds and gets a kick out of hacking everyday objects creatively

Everything in the 21st century office would seem alien to H. G. Wells's Victorian-era time traveller – except for the paper clip.

Invented in the 1870s, the loop within a loop design of this handy little office item hasn't been improved since. William Middlebrook patented the design for the machinery to create paper clips in 1899 and sold it to Cushman & Denison. The American office supply manufacturer registered a trademark for the Gem name in connection with paper clips in 1904. Paper clips are still sometimes referred to as Gem clips, and the Swedish word for a paper clip is gem. While Norwegian Johan Vaaler is often credited as the inventor of the paper clip, his design was different and never mass-produced.

Before the paper clip came along, the straight pin was the paper fastener of choice. While it was cheap and easy to use, it left rust stains and holes in

the paper. In the mid-1800s, the mass production of low-cost steel that had the right balance of strength and malleability helped dislodge the straight pin in favour of more flexible alternatives like the looped paper clip. There were several other clip shapes that were developed close to the beginning of the 19th century. The Fay clip is often credited as the earliest patented design in 1867, followed by the Wright clip patented in 1877, and the Niagara clip a couple of decades later. Some of these clips used less wire, while others could secure larger stacks of paper. However the Gem clip won, not only because of its elegant design, but also because its production was easy to automate. All it took was three bends and a snip. There were no sharp edges and the paper clip was supple enough to snug papers between the loops and then hold them together.

Over the years the paper clip has been twisted, pulled apart, and used as a tool for everything from ejecting optical drives to inserting SIM cards and even to pick locks. Kyle MacDonald famously traded a red one for a house. The humble paper clip was even used as a symbol of resistance by the Norwegians during the Second World War against the Nazi occupation that forbade people from wearing badges or pins depicting national symbols. In a spiritual continuation of that tradition, the paper clip has perhaps been immortalised as a symbol for the digital era in the form of the universal attachment icon.

PAPER CLIP

PAPER CLIP HACKS



MOBILE PHONE STAND

Use pliers to slightly bend upwards one end of the paper clips. Now stretch the other loop in the shape of an inverted V and rest your mobile phone between the two.



BOOKMARKS

Slightly pull one end of the paper clip, wrap a piece of paper around it, and cut it in the shape of a flag. Then press the pulled end back into place.



EMERGENCY ZIPPER

If the pull-tab of a zipper is broken, you can replace it by looping a paper clip through the slider mechanism.



FIND THE SEAM ON A ROLL OF TAPE

Stick a paper clip to the end of a tape roll to easily locate its seam. To use the tape, first pull it with the paper clip and then reattach it to the end before you tear away the tape.



SECURE UNRULY WIRES

Loop a rubber band through one side of a paper clip. Now wrap the band around a coiled wire and hook it on the paper clip to prevent the wire from unravelling.

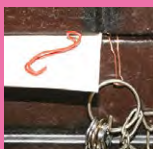

EMERGENCY HOLDER

Straighten a paper clip and then bend it in the middle and use pliers to twist the ends into hooks. Use one end to attach to a drawer and the other to hang trinkets.

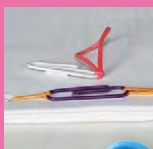

BIND STACK OF PAPER

Knot a rubber band to one end of a paper clip. Then run it through the punched holes in a stack of papers and hook it to the loop at the other end.

TREBUCHET

Alex Palfreman-Brown has the perfect cure for cubicle boredom.

All you need is a handful of paper clips and a pair of pliers. You can use them, together with some other pieces of office stationery, to build a trebuchet that's powerful enough to hurl balls of Blu Tack across the cubicles and wage a war on your colleagues. Alex shows you how to first straighten the paper clips and then intricately shape them into the swinging arm, the axle, the trigger, and other components of the trebuchet. You then assemble all of them on a piece of corrugated card, together with ballast (Alex uses a bunch of batteries), roll pea-sized drops of Blu Tack into balls along with some string, and fire away. The whole contraption takes about an hour to put together. The build is so popular that it has earned Alex several Instructables.com Pro memberships, which he gives away as competition prizes in the hackspace he helps run. The evil mastermind is fully aware of the sinister implications of his war machine: "If I'm ever feeling glum, I just consider how many man-hours have been lost internationally to bored office workers building my trebuchet. That always puts a smile on my face." □

Project Maker

**ALEX
PALFREMAN-
BROWN**

Project Link

hsmag.cc/EvJBQZ

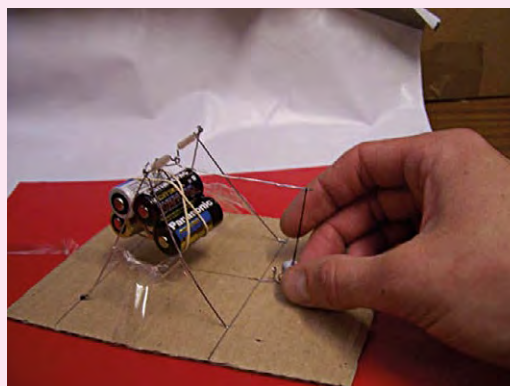

Left ◊ Alex's trebuchet has been featured in two Instructables books and in Bre Pettis's Weekend project videos

FEATURE

PAPER CLIP SCULPTURES

Project Maker
THOMASIN DURGIN

Project Link
hsmag.cc/jiKLUUp

Right ♦
Thomasin started creating this structure while stuck in a wrong job using the materials around her cubicle

Thomasin Durgin is a teaching artist in Memphis, Tennessee and fabricates jewellery using all kinds of metals.

Almost a decade ago she found herself in a cubicle in a job that was “not a good fit” for her. So she started creating art from the materials readily available in her workspace – paper clips. To make these sculptures, Thomasin adopted the traditional basket weaving techniques to work with paper clips. She outlined the shape and then drilled holes into a wooden base and glued several 12-inch-high heavy-gauge wires into them. She then threaded two of these wires into each paper clip, sliding them down and staggering them into rows. This particular sculpture took over 2000 paper clips. Commenting on a photo of her sculpture, Thomasin writes that the process is rather



limiting: “I’d like to adapt true basketry techniques to be able to ditch the wood and create more rounded vessels, spheres, etc. Then I can combine both methods to make more complex structures.” □

MINIATURE WEAPONS

Project Maker
BRETT

Project Link
hsmag.cc/grgFjq

Right ♦
Brett has patiently shaped paper clips into bows and arrows, different types of swords, a gauntlet, as well as a fishing rod

Paper clips are a wonderful medium to express yourself creatively. Their malleable nature allows them to be bent into all kinds of shapes that can be held over a period of time thanks to their sturdiness. Armed with a pair of needle-nose pliers and some glue, Brett took some paper clips and transformed them into beautiful miniature weapons. Brett hasn’t published the procedure for sculpting the paper clip armoury, but you can reverse-engineer his process thanks to the excellent macro photographs of the creations by Brett’s friend, Dan Nicholas. Dan’s images of Brett’s awe-inspiring work are detailed enough to help you make out each and every bend, turn, and twist of the paper clips. If you’re like us, all it’ll take is one look at Brett’s rudimentary weapons and you’ll be instantly compelled to try your hand at creating them. □



METAL RACE GAME

A talk on the rise of mobile gaming back in 2009 inspired game designer Greg Borenstein to build a physical one-dimensional scrolling game based on a racing game he played on the TI-83 series of graphing calculators. In his version, the player's car essentially stays in place while the track scrolls from right to left at a constant rate. The player can move the car up and down to navigate the twists and turns of the circuit. Greg used a couple of motors to move the car and the track that was made out of paper clips. A triangular piece of metal serves as the car and when it comes into contact with the paper clip circuit, they close a switch that triggers a buzzer indicating a crash and the end of the game. Greg has detailed the mechanical and electrical parts of the build in a couple of blog posts and also published a video of the whole contraption in action. □

Below ▣
Greg soldered several paper clips into a maze track that stays within the attached motor's vertical travel range

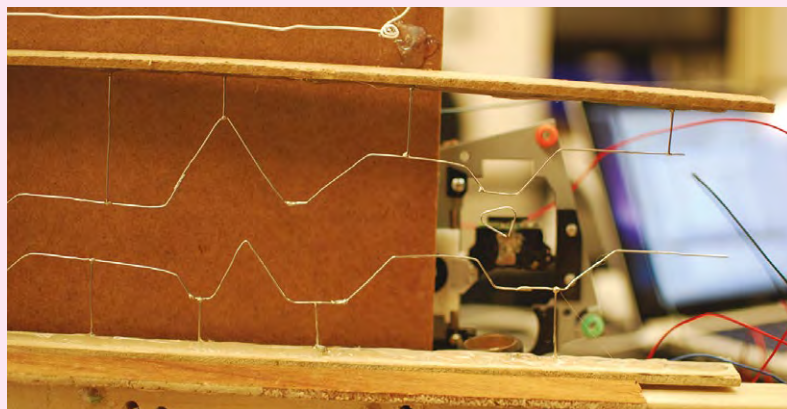

Project Maker
GREG BORENSTEIN

Project Link
hsmag.cc/rkoNAM

PAPER CLIP JEWELLERY



Lina is a master crafter and a mum of two young kids. Inspired by a blog post on another website, Lina engages her kids creatively by using a bunch of paper clips and some duct tape to design some simple pieces of jewellery. She hooks paper clips together to the desired length of the necklace or bracelet and then wraps about an inch of tape around the middle of each clip. While it sounds simple, the end result is an attractive trinket. Lina's post is dotted with images and she also discusses ideas to extend the simple designs by adding more paper clips and dangling beads and small pendants to the end. "This is a great craft for summer camps, scouts, or simply an afternoon at home," writes Lina, whose kids love the paper clip jewellery. □

Project Maker
LINA DARNELL

Project Link
hsmag.cc/oAlbCs

Left ▣
Bump the designs a notch or two by using a pair of pliers to bend the paper clips and create artsy-looking pendants

White Rabbit Nixie clock

By Jack Edjourian

hsmag.cc/JgZrNR

Nixies are considered obsolete as they are no longer in production, and the Nixies we purchase tend to have been produced in the 1970s and 1980s. Due to the nature and lifespan of a Nixie, we wanted to design a housing which will allow the owner to close it and de-energise the six time-telling Nixies, allowing for a longer life for all the Nixie tubes.

On the White Rabbit clock, we had access to a laser cutter for the first time and took full advantage of the wonderful machine. After a few prototypes in acrylic, we cut the parts for the final clock in dark walnut, maple, cocobolo, padauk, spruce, and Russian ply.

The clock was not a simple cut, glue, and done project: wood grain direction in relation to each part and its function was very important, and tests were done to stress the wooden mechanical load-bearing parts to find the optimum grain direction for each part. Cocobolo was our wood of choice for the mechanicals as it's dense, can be tapped, and is also beautiful! Parts had to be sanded and adjusted, and some parts were cut from wood blocks and shaped. We also decided to inlay wood on all the external covers, and finally add a high gloss finish.

The electronics were put together and the harness routed. An internal microswitch detects the clock's open or closed condition and powers up or puts the Nixies to sleep. The blue LEDs are very common now in these clocks; we always build in a switch to turn these on or off, as sometimes they can become very distracting. As with our cyclops clock, when we turn the lights out, the room looks like there's a close encounter of the third kind taking place! ▣

Right

External components have three layers of catalysed automotive lacquer – internal parts are left with a natural finish to keep tight tolerances





How I Made

RASPBERRY PI READING GLASSES

Using a Raspberry Pi and a camera to read text out loud

By Andrew Lewis

There are approximately 370,000 people registered as blind or partially sighted in the UK. It's estimated that around half of those people suffer from age-related macular degeneration (AMD). While AMD doesn't cause total blindness, it affects the centre of a person's field of vision and makes reading text very difficult. Conventional magnifying glasses, Fresnel lenses, and other assistive devices can only help a person with AMD up to a certain point.

A Raspberry Pi, with a camera connected, can help people with AMD read text, using the Python programming language, computer vision, and a text-to-speech library. The flexibility and portability of the Raspberry Pi means that the system can take advantage of a pair of camera glasses, or use a fixed camera on a stand to recognise text.

This is a simple project to assemble, since it uses off-the-shelf components and requires minimal soldering. Although the project is presented here with a pair of camera glasses, it can be modified to work with a camera clipped to the frames of an existing pair of glasses or as a standalone

desktop reader on a photographic copy stand. The most important part of the project is the choice of camera. A better quality camera will give you a better image, and that will give you better recognition results.

JUST PLUG EVERYTHING IN

Begin by connecting the switch to the Raspberry Pi. The code in this article uses GPIO21, which relates to physical pin 40 on the GPIO header. Connect one side of the switch to pin 40, and the other side to pin 39 (GND). The cable should be long enough to reach the outside of your choice of enclosure, without having too much excess.

Fit the Raspberry Pi into its case and connect the battery pack to the Raspberry Pi with a USB cable. Try to use the shortest USB cable you can find, as this will of course look neater.

Plug the camera into the Raspberry Pi and then position the Raspberry Pi on top of the battery pack, so that the shape of the case provides some protection from damage. This position will vary depending on the choice of USB power supply you have and the case you are using. Once you are happy with the positioning of the



Above ♦ The Raspberry Pi Reading Glasses can be adapted to do much more than reading text out loud

One morning, when Gregor Samsa
 woke from his dreams, he found
 himself transformed into a
 horrible insect. His first
 thought was to lie back on his
 belly, but he could not do
 this. He tried to raise himself
 onto his hands, but he only
 made the ceiling creak. He
 lay there, motionless, for
 many days.

Left ◊
 Macular degeneration affects the centre of a person's vision, but the end result is not always as simple as a blank space. Sometimes, a jumbled or distorted image (or even a visual hallucination) may appear in the affected part of the eye

components, use double-sided foam tape to hold them in place. You may also want to give extra protection to the USB and button cables by adding a small dab of hot glue, to stop them from working loose.

With the exception of positioning the switch in the device's carry case and plugging the headphones into the audio socket, this completes the hardware portion of the project assembly. The next step is to start working on a Python application to make everything work.

The Reading Glasses application doesn't have a screen, so the first thing that the application needs is a way to communicate with the user. The application will already be using a text-to-speech engine, so a combination of spoken word and sounds (earcons) can be used to provide suitable feedback to the user. Earcons are just short, uniquely recognisable sound files that get played to indicate something has happened. Playing these using Python is easy, as the following code demonstrates.

```
#use pygame mixer to play boot sounds
#talkey takes a long time to initialize,
so do this now
import pygame
pygame.mixer.init(frequency=16000)
pygame.init()
pygame.mixer.music.load("startup.wav")
pygame.mixer.music.play()
```

This code uses the Pygame library to load a file called **startup.wav** and play it through the default sound device. In this example, the sound file is a recording of a computer-generated voice, saying that the system is booting up, and that it might take a minute to initialise everything. A recording is used here because the Python text-to-speech engine takes several seconds to initialise, and the message is

played as soon as the application starts. This early feedback is important because it tells the user that the device is working, and that there will be a short delay before the next thing happens. Other messages generated after the text-to-speech engine has initialised will use the engine directly, but this early message needs to be pre-recorded.

Python has several different libraries available that deal with text-to-speech, and we are going to use the easiest of them, Talkey. Talkey acts as a front end to many different speech engines, and uses a simple syntax to read text strings out loud. While it's tempting to use something like Google's own voice synthesis to generate near-human-sounding voices, the Reading Glasses application would require an active network connection to do this, and so the self-contained Pico engine is used instead.

GIVING FEEDBACK

There are several different states that the Reading Glasses can be in, and each of these states can be represented with a sound. Starting up the app has already been dealt with, but other messages will come directly from the text-to-speech engine, so this needs to be initialised →

Left ◻
 Assembly of the parts is straightforward, with minimal soldering

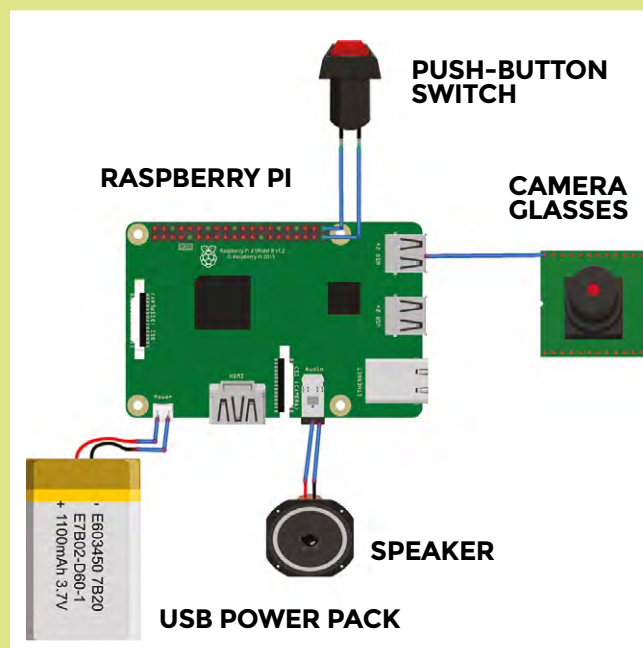

QUICK TIP

This project has several dependencies, all of which must be installed before you start: Python 2.7 with Pygame, Talkey, PIL, OpenCV, NumPy, RPi.GPIO, pytesseract, Pico text-to-speech engine, Tesseract.

What I used

- Raspberry Pi 3 and case
- USB battery pack and power cable
- Camera glasses, or a Raspberry Pi camera
- Push-button switch (normally open)
- Earphones
- Double-sided foam tape
- A camera case



Left  The physical effect of AMD on the retina is easy to see when viewed up close

device will vary, depending on the camera you use. In this example, the device has a frame width of 2304 pixels, and a height of 1536 pixels.

```
import cv2
import time
import pytesseract
import numpy
from PIL import Image

def getImage():
    # Try to open the camera, resolve if
    # fails
    # returns an image from the camera
    cam = cv2.VideoCapture(1)
    cam.set(cv2.cv.CV_CAP_PROP_FRAME_
    WIDTH,2304)
    cam.set(cv2.cv.CV_CAP_PROP_FRAME_
    HEIGHT,1536)
    while not cam.isOpened():
        say(msg['camfail'])
        cam = cv2.VideoCapture(0)
        cv2.waitKey(10000)
    ret_val, image = cam.read()
    return image
```

next. All of the messages that the app uses are held in a single dictionary called `msg`. The following code sets this up, imports the TTS engine, and creates a function called `say()` that generates audible output.

```
msg={
    'camfail':"I'm having trouble connecting
    to the camera. Check the cable is
    connected, or try holding down the
    camera button for 5 seconds.",
    'init':"Almost ready.",
    'ready':"Hello. I'm ready to work now.",
    'notext':"Sorry, I couldn't find the
    text."
}
```

```
import talkey
#setup the TTS engine and notifications -
happens before everything else
tts=talkey.Talkey(engine_
preference=["pico"])
```

```
def say(txt):
    tts.say(txt)
    print txt
```

```
say(msg['init'])
```

The app now has a method of output, but it doesn't have any way to get input from the user. This means activating the camera, and configuring the action of the button plugged into the Raspberry Pi. The camera is accessed through the OpenCV library, and the button uses the Raspberry Pi GPIO library. First, let's deal with the button by setting up the GPIO pins and activating a pull-up resistor to stop the input from switching randomly when not being pressed. In this example, the switch is connected to the GPIO21 pin.

```
# import the necessary packages
import RPi.GPIO as GPIO

# activate the pullup on the GPIO pins
GPIO.setmode(GPIO.BCM)
GPIO.setup(21, GPIO.IN, pull_up_
down=GPIO.PUD_UP)
```

Now that the button is active, the camera needs to be configured. Properties like the frame height, width, and camera

It's likely that the camera will get accidentally disconnected from the Raspberry Pi at some point, particularly if you are using camera glasses with cables that can be snagged on clothing during use. You can see from this section of code how the application provides feedback to the user if the camera is not found.

The next part of the Reading Glasses application is the `main` function, which ties the other functions together. The `main`

Failure

These reading glasses can be put through pretty tough usage. As they're important to the user, it's good to make sure they're made as solidly as possible. It's also good to keep a spare SD card loaded with the software that can be swapped in if there are any problems.

function checks the camera is working, and then tells the user that the system is ready. When the button is pressed, the application calls the `look()` function that takes a photo, detects the text, and reads it out loud.

```
def main():
    cycle_init=time.time() # this is for
    the button-press debounce
    ret_val = getImage() #check the
    camera is working as soon as we start
    say(msg['ready'])
    while True:
        btn = GPIO.input(21)
        #if the button
        is pressed and not same press as last
        time
        if btn == False and time.time()-cycle_
        init > 1:
            look()
            cycle_init=time.time()

if __name__ == "__main__":
    main()
```

The `look()` function is too long to be reproduced completely in this article, but the full code is available for download from [hsmag.cc/issue6](#) (click 'Download

resources'). The basic outline of what the function does is shown below, and the code itself is heavily commented.

1. The `look()` function takes an image from the camera and plays an earcon to let the user know what's happening.
2. The image is converted to greyscale, and areas of high contrast are detected. These high-contrast areas typically happen at the edges of letters on a page of text.
3. The contrasting areas are clustered together into 'blobs', and if the blobs are the right size they get added to a list of paragraphs. If you are having trouble getting the camera to recognise text, then try adjusting the values at the beginning of the `look()` function.
4. The blobs in the list are manipulated to remove any skew and rotation in the chunks of text, and then they get scaled and passed into Tesseract, which deals with the text recognition part of the function.

Interaction

Getting feedback from an application or device is very important. When you touch a button, your action is usually acknowledged with a click or a beep. Lights, sounds, and text displays will tell you where an elevator is and where it will be calling next. Even virtual buttons on a smartphone screen will click or vibrate as a user pushes keys on the keyboard. Not providing adequate feedback for an action can make the user feel less confident about using an application or device, and may even mean that they stop using it altogether.

5. The Tesseract engine takes the images and converts them into strings of text.
6. The strings of text get passed to the text-to-speech engine, which reads them to the user.

To get the Reading Glasses up and running, you will need to get the Raspberry Pi to automatically execute the script when it boots. First, make sure that your reading glasses python script is called `glasses.py`, is located in the default user's home directory (`pi`), and has `#!/usr/bin/python` at the top of the file.

Now use nano to add a line to the bottom of `/etc/profile`:

```
sudo python /home/pi/glasses.py
```

These instructions should be all you need to create a basic set of Raspberry Pi Reading Glasses that can read text out loud to the user. There are lots of potential upgrades that you could make, especially if you are involved with computer vision. It's possible that gestural interfaces could be used to control the Reading Glasses, or you could add extra functions like facial recognition, object detection, or colour recognition. □

Left
The assembled reading glasses, ready for use





How I Made

A CHICKEN COOP OPENER

The making of some fowl technology

By Andrew Lewis

Chickens are great. They're like little dinosaurs that turn slugs and plants into eggs and fertilizer for your garden. Aside from food and water, chickens mostly look after themselves. The only real chore is that they need to be shut into their coop when the sun sets, and let back out again when the sun rises. If you find yourself away from home unexpectedly, you inevitably end up worrying about the chicken door. After a month of chicken door anxiety, I decided that I'd find a technological solution to the problem.

The requirements for a door opener are very straightforward. It needs to open a wooden door when it's light outside, and close it again when it's dark. It also needs to lock the door closed if we want to keep our chickens confined for some reason. I'm no stranger to electronics or making things, but I was surprised how much of a challenge this 'simple' chicken door opener presented. The chicken door mechanism isn't complicated, but in our case, running a power cable to the chicken run wasn't practical. That meant the door opener needed to run from batteries, and

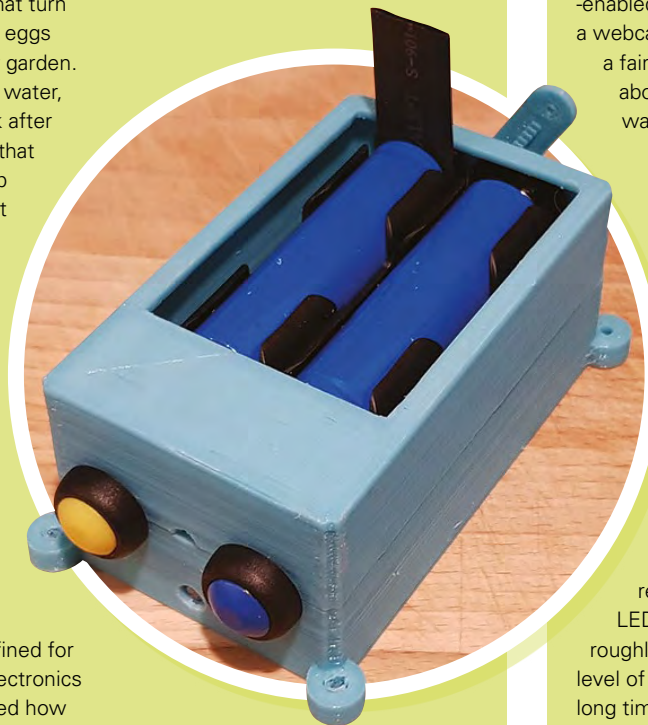

Above ♦ The MK2 chicken door opener assembled in a 3D-printed case, with batteries

my initial plans for a fancy Internet of Things-enabled chicken door with a phone app and a webcam were modified into something a fair bit simpler. I had to think very hard about how much power the project was going to need.

The first issue I had to consider was idle power consumption. A standard Arduino Uno uses roughly 40–50 mA of power at idle. Even if you put the Arduino to sleep when it's not being used, the on-board monolithic voltage regulator still uses a fair amount of power. The 5V version of the Arduino Pro Mini is much more frugal, using around 20 mA when idle, and 3 mA when asleep. A little bit of internet research told me that bypassing the on-board power regulator and disabling the power LED could reduce this number to roughly 0.005 mA during sleep mode. That level of power could be sustained for quite a long time by a bank of four AA batteries.

The type and power consumption of the motor was also a factor in the design. I initially wanted to use a geared motor to control the door, but realised that there would be a couple of problems with this. The geared motor would lock into position

when the power was disconnected, which would mean that I couldn't move the door by hand if the mechanism failed. I would also need to add sensors or limit switches to monitor the position of the door. I already had some high torque servos in my workshop, and I decided to use one of those. The current draw from a permanently activated servo would have drained any batteries I had in a few hours, so I added a relay that would only power the servo when the door needed to move.

Although the power used by the light-dependent resistor is trivial, I decided to apply the same principle that I had used with the servo and only supplied power when a reading was being taken. In addition to the LDR, I added a potentiometer to set the threshold light level that the door would trigger at, and a simple push-button that would be used to close and lock the door for ten minutes. I thought that ten minutes would be enough time for us to clean or move the coop, and I didn't want to accidentally lock the chickens in for an extended period. I came to regret this decision later, as we were chasing three fugitive birds around the vegetable garden.

Below

The MK1 chicken door, installed on the coop. It's a bulky unit and it's difficult to set the light level using the potentiometer, but it does work

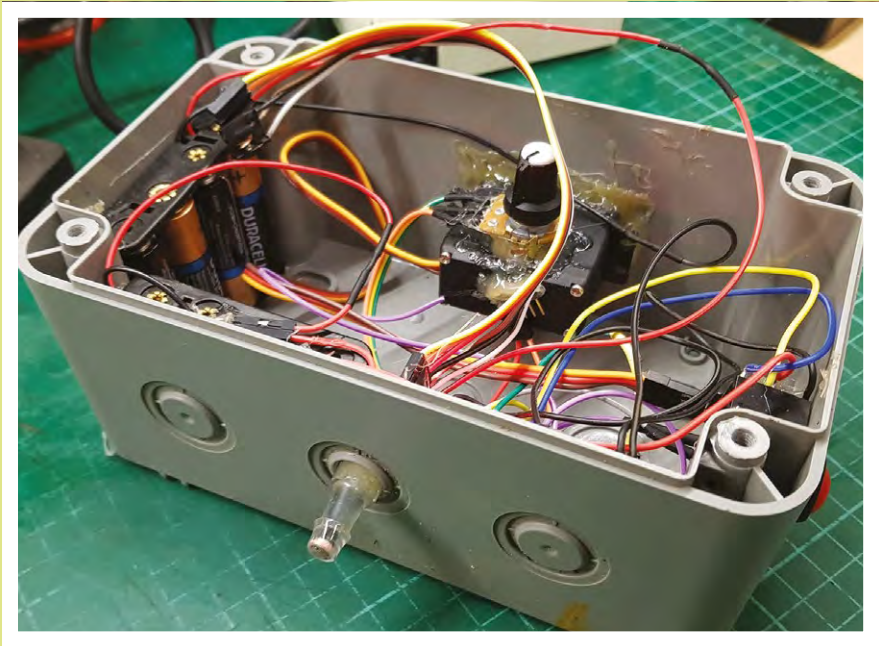

Above ♦ The MK1 chicken door opener, with lid removed to show the potentiometer and battery boxes. It's a mess of wires, and that makes it easy to knock something loose when the batteries are being changed

I assembled the door opener into a waterproof electrical box, programmed the Arduino, and gave the system a test. It worked initially, but started to misbehave when any load was put onto the servo. I realised that the current being drawn from the batteries was too great, and the servos were making the Arduino brown-out and reset. I modified my design, added a separate battery bank just for the servo, and tried again. This time the door operated as expected, so I sealed everything into the box and fitted the unit to the chicken coop.

Several weeks later, the door of the coop failed to open. This failure was sooner >

The Rocket Scream Low-Power Library

An Arduino Pro Mini is usually based on the Atmega328p processor, running at either 8MHz or 16MHz, depending on the version of the board. The Low-Power library by Rocket Scream (rocketscream.com) allows you to put the Atmega328p into a power-saving state using simple commands, which vastly improve longevity while running on battery power. As an example, to make the chicken door go into power-saving mode every two seconds, I imported the Low-Power library and used the following command:

```
LowPower.powerDown(SLEEP_2S, ADC_OFF, BOD_OFF);
```

This command tells the Arduino to sleep for two seconds, and to turn off the ADC (analogue to digital converter) and the BOD (brownout detector) during this sleep period. You can also do more advanced things with the library, like using hardware interrupts to wake the Arduino from sleep.

FEATURE

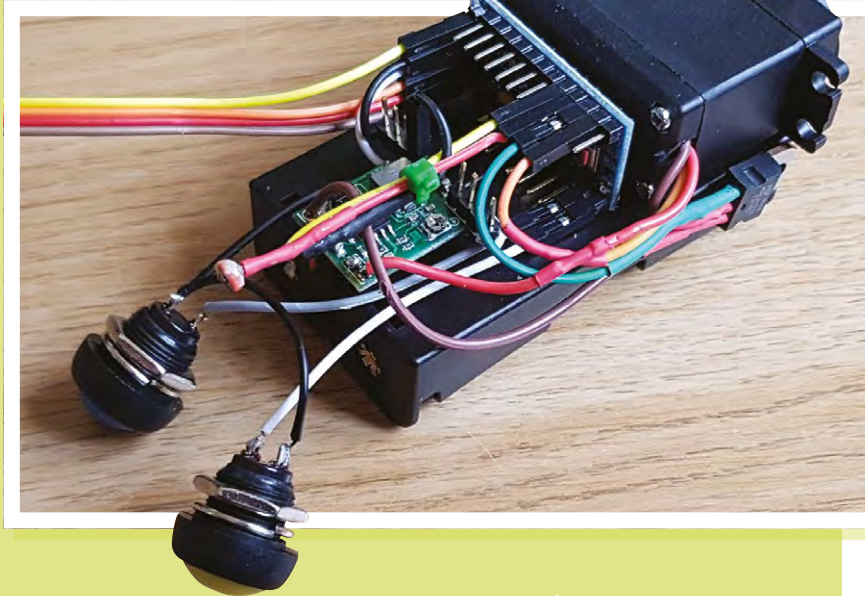

Above ♦ The MK2 chicken door opener with all of the sensors and buttons connected to the Arduino. The PCB above the Arduino Pro Mini is a voltage regulator

than I had expected, but I replaced the batteries and ran another test. The door opened and closed properly, and I thought nothing more of it. The following morning, I faced the same situation again. I concluded that something must have happened to either the wiring or the Arduino, and chose to make a new improved version. I had a functional workshop, and so I thought that I would be able to make a better job the second time around.

I opted to use 18650 batteries on the new door opener. 18650 batteries have a

the same as the maximum recommended voltage for the servo.

CHICKEN DOOR MK2

I started the new build with another Arduino Pro Mini. I bypassed the internal voltage regulator and added a more efficient external buck (step-down) converter. I added a light-dependent resistor to an analogue

stay closed until the second button was pressed to unlock it. Once the door had been unlocked by the second button, it would operate normally and close by itself when it got dark enough.

On the original chicken door opener, I used a potentiometer to set the trigger level for the door. I found later that it was very difficult to set the level this way, because it was easy to knock the potentiometer or move it accidentally. This time around I took advantage of the extra button I'd added, so that pushing both buttons together for three seconds would take a reading from the light sensor and use this as the threshold level to open and close the doors.

I used a TIP120 to control the power to the servo, rather than a 5V relay as I'd done in the original version. I did this mainly because I had one handy on my desk, but also because the TIP120 is smaller than a 5V relay and has no moving parts. I know that the TIP120 isn't very efficient by modern standards, but in this project it's only powered up for a few seconds at a time, and it's so over-powered for the job that it'll never dump enough heat to get even slightly warm.

I assembled all of the parts using the plastic battery holders as the main chassis, and fixed each of the components in place using double-sided neoprene tape.

I started the new build with another Arduino Pro Mini.

I bypassed the internal voltage regulator and added a more efficient external buck converter

much higher drain current and voltage than AA batteries, and are rechargeable. Two 18650 batteries should be enough to power the Arduino and servo for several weeks at a time, and the more compact batteries meant that I could reduce the size of the whole project significantly. Connected in series, the 18650 batteries give 7.4 volts when fully charged, which is serendipitously

pin, using a standard potential divider set up between a digital pin and the ground pin, so that I could power down the LDR when it wasn't being used. I added two buttons to the Arduino, and activated the internal pull-up on the pins I connected them to. The first button closed the door, just as it had on the first version of the chicken door opener. Unlike the original unit, the new door would

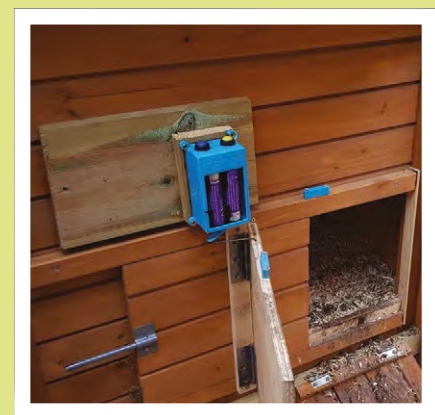

Above ♦ The MK2 chicken door, installed on the coop. The battery cover has been removed to show the 18650 batteries inside. This unit is more compact and much easier to set up

I 3D-printed a suitable case, and sealed the seams of the unit together using a hot soldering iron. I was feeling quite pleased with the project at this point, and it's a pity that it only worked for three days.

POINTS OF FAILURE

I'd made a couple of mistakes in my design, and misunderstood the cause of the original unit's failure. Firstly, I hadn't included a backwash diode, to absorb reverse current feeding back from the servo. This wasn't a big problem in the original version, because it used a relay and had an independent battery bank. In the new version of the door opener, the relay was replaced with a transistor, and wired to the same supply as the Arduino. This caused some stability problems.

The most important issue was that the servo still seemed to be drawing too much current from the batteries. This confused me at first because I knew that the output current of an 18650 battery should be able to power the servo. Even more confusingly, after I'd tried to open and close the door a few times, the opener started working properly. It took me quite a while to realise that the problem wasn't inside the box, it was actually the environment that I'd put it in. Like most batteries, 18650 cells are very sensitive to cold conditions. The capacity rating printed on batteries is usually calculated for a temperature of around 25 degrees Celsius. The chicken door opener had worked perfectly through the warm summer months, but the capacity of the batteries had fallen as the temperature approached freezing. The final point of failure was that I'd used some unprotected batteries from my spare parts bin, and the voltage had dropped too low for them to be recharged.

IMPROVEMENTS

Once I realised the problem, the solution was simple enough. I added a 5V ultra-capacitor after the power regulator, and this made sure that the Arduino still receives enough current when the servo is draining all of the power from the battery. Capacitors are less affected by low temperatures than batteries are and, with a new set of

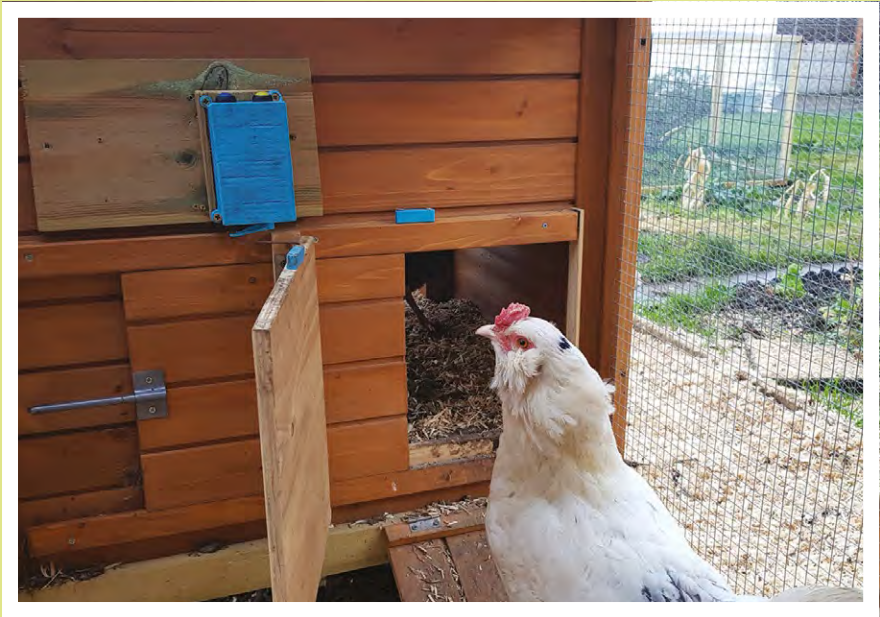

protected 18650 batteries, the Chicken Door Opener MK2 has been working for several weeks without incident.

When the weather improves, I'll probably update the code on the Arduino so that the light level that triggers the door is stored in EEPROM rather than RAM. There's no rush to do this, because the ultra-cap can keep the Arduino powered up for several hours even without batteries installed. □

Above ♦
The customers inspect our handiwork

Below □
The final circuit has proved reliable and easy to use

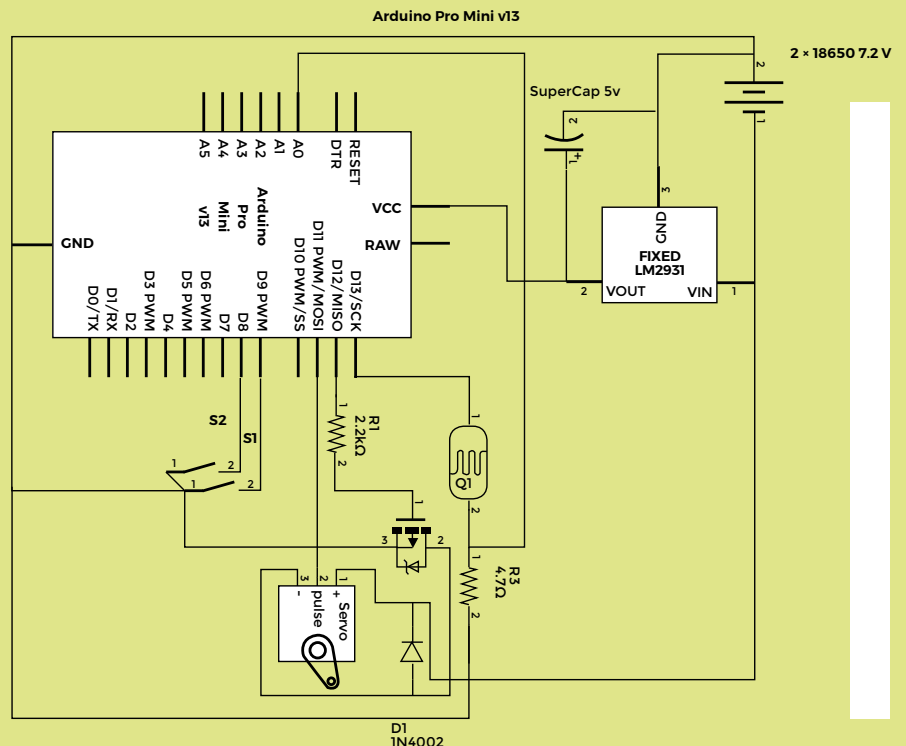



Don't work with pyrotechnics unless you have the appropriate knowledge and skill. You are responsible for your own safety. Take that responsibility seriously.

How I Made ROCKET LAUNCHER STRANDBEEST

Let slip the creepy-crawlies of war

By Jeremy S. Cook

I've been making things for as long as I remember, and the idea of a walking robot has always been especially fascinating.

After several walker attempts of varying success levels, in mid-2013 I was introduced to Theo Jansen's Strandbeest. These amazing creatures walk along a beach or other surface, powered only by wind, and controlled by an ingenious linkage mechanism.

While I at first ruled out making one, considering it an interesting curiosity that was beyond my grasp, I eventually did decide to make a single leg out of wood, fastened together with linkages constructed from PVC pipe. Soon, one leg multiplied to four, and these legs 'somehow' transformed into an entire four-legged contraption that never really walked correctly. After this, an also-not-walking eight-legged golf cart-sized beast followed, two smaller models did actually walk under remote control, and what I called

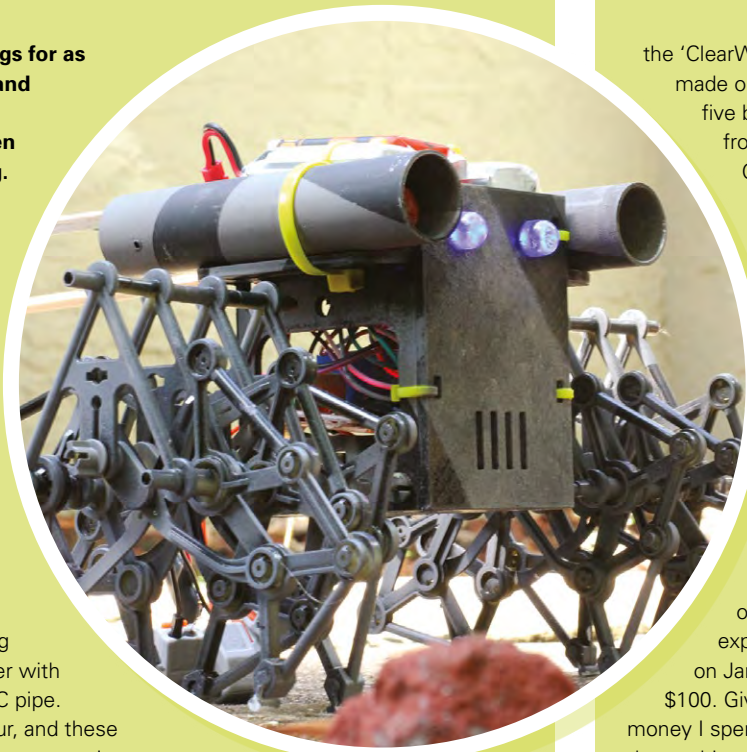

Above ♦
The fully assembled Rocket Beest, ready for action

the 'ClearWalker', a two-foot-tall beast made out of clear polycarbonate. So five beasts, spanning several years from that small bit of inspiration. Consider yourself warned: these walkers are not easy to make and will consume years of your life, even with Jansen providing the necessary linkage lengths. At some point during this process, I realised that you can simply buy a kit if you want your own Strandbeest walker. It would have made sense to buy one first to see how it works, but somehow this idea was initially lost on me. Perhaps they seemed expensive at the time, since those on Jansen's site run for well over \$100. Given the amount of time and money I spent on the five iterations outlined above, this would have been an extreme bargain – but wouldn't have been as much fun either.

Regardless, in late 2017 I ordered a few generic beast kits, available for under \$10, if you look hard enough. The kit



Left ♦
Measure twice, cut once, and your beast will fit together

design is a true masterpiece, considering how cheaply it can be produced and how well it goes together, and the fact that it walks under wind power, just as Jansen intended. While fun, replicating someone else's design verbatim as a kit doesn't really satisfy my creativity needs, so I set to work modifying it, implementing a crude remote control system, with a key fob remote. While less interesting than the eventual Rocket Launcher Strandbeest, it did teach me a few valuable lessons on how to modify one for remote control.

POWER TRANSMISSION

I found that the beast kits can easily be split into two sections, and that they contain small metal rods that keep them linked together when separated. The driving camshaft is in two pieces, so you can 'simply' attach motors on each of the resulting six-legged sides, allowing it to walk and turn as if it was using a pair of tank treads for locomotion. The challenge here, as well as with any of my Strandbeest builds, is transmitting power from the motor's output shaft to the beast's crankshaft. In heavy equipment – and in my more successful beests – this means a shaft coupling of some sort, but the plastic design of the kit didn't lend itself well to this kind of configuration. Instead, I used hot glue.

Yes, that's right, in order to attach the motor and camshaft together, I

used a copious amount of hot glue, not traditionally known for its power-transmission capabilities. But, since this beast is light and moves smoothly with little friction, this actually turned out to work pretty well.

I cut a slot in the kit's crankshaft just large enough to insert the motor's output shaft and, after a generous dab of hot glue, pressed it into that space. To further hold it, I wrapped a zip tie around the crankshaft-motor combo as quickly as I could and pulled it tight. Importantly, the motor has a flat on one side to help with power transmission, and after slotting the camshaft, the motor was indeed able to turn the kit-beest's crank and legs. While this was nowhere near the last challenge this project would face, at least I knew I could get it to move with the proper electronics applied.

The real 'wow' factor for this little beast would be the fact that it can actually launch rockets, but I wanted it to look awesome too.

My idea was to have all of the electronics stuffed into a compartment in the middle, with a pair of rocket tubes straddling it, sort of like a robot from *MechWarrior*. Form still had to follow function, though, and I set to work diligently measuring the distance between the three connection points on the body that normally plug into each other, along with the location of the crankshaft that powers the kit.

With these measurements in-hand, I then designed a 3D-printed chassis in Autodesk Fusion 360, with holes for the connector plug, along with a rectangular opening to constrain the driving motors. I also added several openings in the body to save print time, which turned out to be extremely helpful later when I needed to assemble the electronics. To my pleasant surprise, everything fitted together properly after the body was printed. I wouldn't have to go back to the drawing board, save for a few small modifications with manual tools. Still, the body was a rather uninteresting shade of black, and needed something more to make it complete.

I first covered the new body and kit legs in a layer of black spray-paint. Taking inspiration from the geometric patterns that you might see on a WWII battleship, along with the matte grey of AT-ST walkers from *Star Wars*, I applied masking tape on the body and legs, >

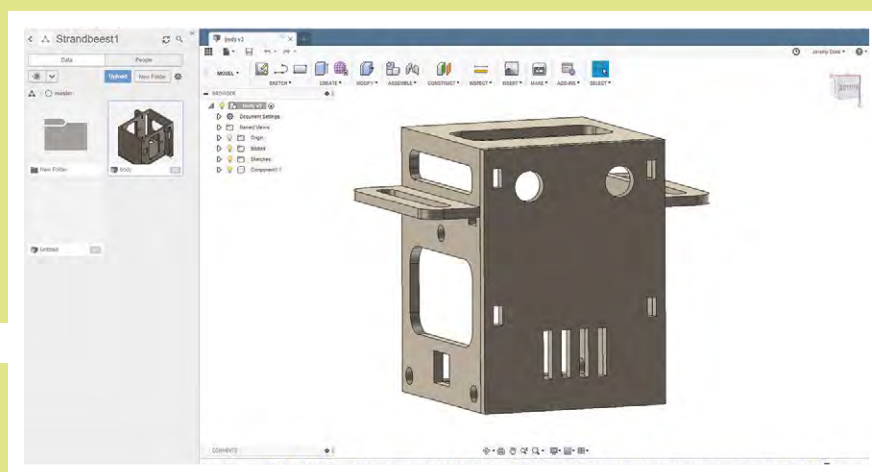

Right ♦
A 3D-printed head holds the electronics, and gives the beast a bit of personality

FEATURE



Above ♦ A rotary tool is great for making little modifications to plastic kits

and painted it with grey (granite) spray-paint, giving it a look that I was really happy with. The 3D-printed face and launcher tubes were also painted in the same manner, though they would come a little later.

ELECTRONICS

I knew my Rocket Beest looked good, and that I could get it to walk, but actually stuffing all the electronics inside was quite the challenge. I'd settled on a compact Arduino Nano as the brains of this device, along with a Bluetooth module to allow me to steer it and fire rockets via a smartphone. A pair of relays was used for rocket ignition, and a motor driver board controlled – you guessed it – the two leg motors. The variety of electronics used meant splitting everything into two small perf boards, with components attached with solder and hot glue.

While things worked outside of the Rocket Beest's body, stuffing it inside was a matter of Dremel tool 'adjustments' and careful wire-yoga. As noted earlier, the cut-



Above ♦ A lick of paint can transform the look of your build

outs meant for time/filament savings came in very handy here, as the circuit boards were slightly wider than the body, and ended up fitting nicely in these windows.

While testing its walking function with the boards in place, powered by a pair of 3.7V LiPo batteries in series, I was inspired to design and print the distinctive 'face' of the robot, painting it in the same way as the rest of the body. Blue 10mm LEDs were used as eyes/headlights which, along with its mouth-grate assembly, give it a lot of extra personality.

ROCKET LAUNCHER!

With the face and rocket tubes strapped on with zip ties, everything appeared to be in place, but the design's key feature – automatic rocket launching – was still not ready. A small disclaimer: I'm not suggesting that you try this project, and can't guarantee its safety generally [Editor's note: this is a dangerous project, and could cause serious injury. Just because Jeremy survived, it doesn't mean you will. Don't attempt to

recreate it unless you've got the skill and experience to work with pyrotechnics]. If you do decide to build something that can shoot a potentially dangerous projectile [Editor's note: we strongly recommend you don't], be sure it's always pointed in a safe direction when there's a possibility of ignition. As you'll see later, following this protocol helped keep me safe during testing.

I decided that Nitinol wire would be a great choice for launching rockets, since running electricity through a thin strand causes it to glow red with heat. Actually holding the wire was difficult, though, as soldering it proved to be difficult, and I wanted this wire to be able to be easily replaced when needed. I chose to use alligator clips to hold short lengths of Nitinol, with the positive wires connected to the NO terminals of my dual relay board. The idea was that when the signal was given via Bluetooth, the Arduino would signal the appropriate relay to close the NO terminal, gloriously lighting its rocket payload.

As it turns out, it did gloriously light one of its rockets... as soon as I plugged it in! No damage to me or the surroundings as I had it pointed 'downrange', but the relay wiring was thoroughly melted. I'm still not entirely

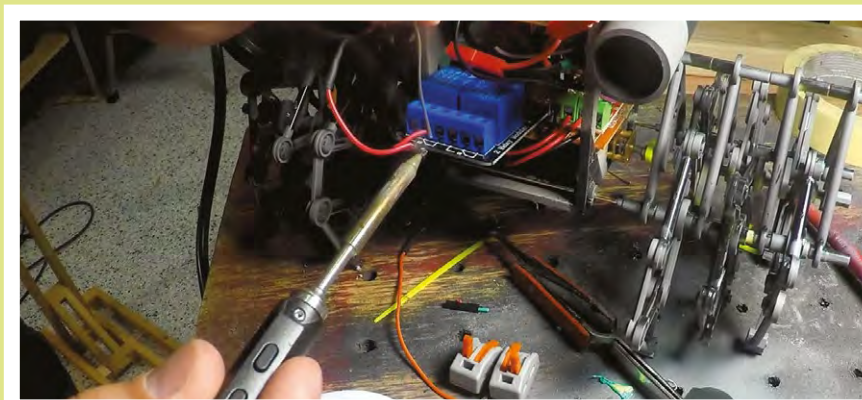

Left ♦ Final assembly and testing

sure what happened, but I suspect one of the relays was mistakenly hooked up to the NC terminal, and there may have been an issue with the program as well. Whatever it was, I took several steps to shore up my electronics before the next attempt.

ROCKET LAUNCHER, TAKE TWO!

With my self-imposed deadline for publishing a video about my Rocket Beast (find it here: hsmag.cc/UStqJp) approaching, I redid the launching system with several improvements:

- Code changed so that the Arduino output pin would not even be set as an output until the fire button was activated. Normally, you declare your 'pinMode' in the setup section, but here I waited until the fire routine was called, to avoid any potential issue with it momentarily flickering to the wrong state. Firing time was increased to three seconds, to ensure fuse ignition.
- Made sure that each positive rocket lead was hooked into the NO terminal. Things got a little confusing between the relay being active low and switching to a NO output terminal, but after careful consideration, everything was properly connected.
- Instead of powering the Nitinol launch wire from the Rocket Beast's main power supply, I added a disposable 9V battery to apply voltage separately. This was meant to avert potential power issues with the rest of the Rocket Beast.
- Lever nuts substituted for alligator clips. These devices are used in place of traditional wire nuts, and hold each wire individually with a lever mechanism. What I purchased was rated for a range of wire sized

between 28 and 12 American Wire Gauge (AWG), and it held my Nitinol wire, even though it was actually smaller at 30 AWG.

- Deburred the end of the launcher tubes. Cutting had left a rather pronounced internal edge, which on the first test had caught the rocket and caused it to go awry during the launch sequence.

The second rocket was also fired successfully, and coincidentally (?) I could hear fire engines in the background after this test. While it turns out my name isn't Norman, and Fireman Sam wasn't coming to save me from peril, the question of what my neighbours thought of this activity wasn't too far out of mind.

Making the Rocket Beast took somewhere around a month by itself, and years if you include its predecessors. Even

with all this effort, it was a lot of fun to construct, and I'm extremely happy with the results.

While I've told myself and others many a time that I would move on to other projects – and do make a wide variety of

gadgets both for fun as part of my job – the Strandbeest concept seems to be quite the recurring theme.

This, however, is probably the last one I'll build... until another 'must-do' walker idea demands to be constructed, of course! ▣

I'm not suggesting that you try
this project, and can't guarantee
its safety generally

With all that done, I again carried the contraption into the back yard and, even more gingerly, connected the main power wires. No initial flames this time – a good sign – and after connecting to the system's Bluetooth module, I hit the launch button on my Bluetooth-connected smartphone. This time the Nitinol wire did heat up, followed by the fizzling and smoke of the rocket's fuse, and finally the satisfying 'woosh' of success!

Below ▾
3... 2... 1... Blast-off!



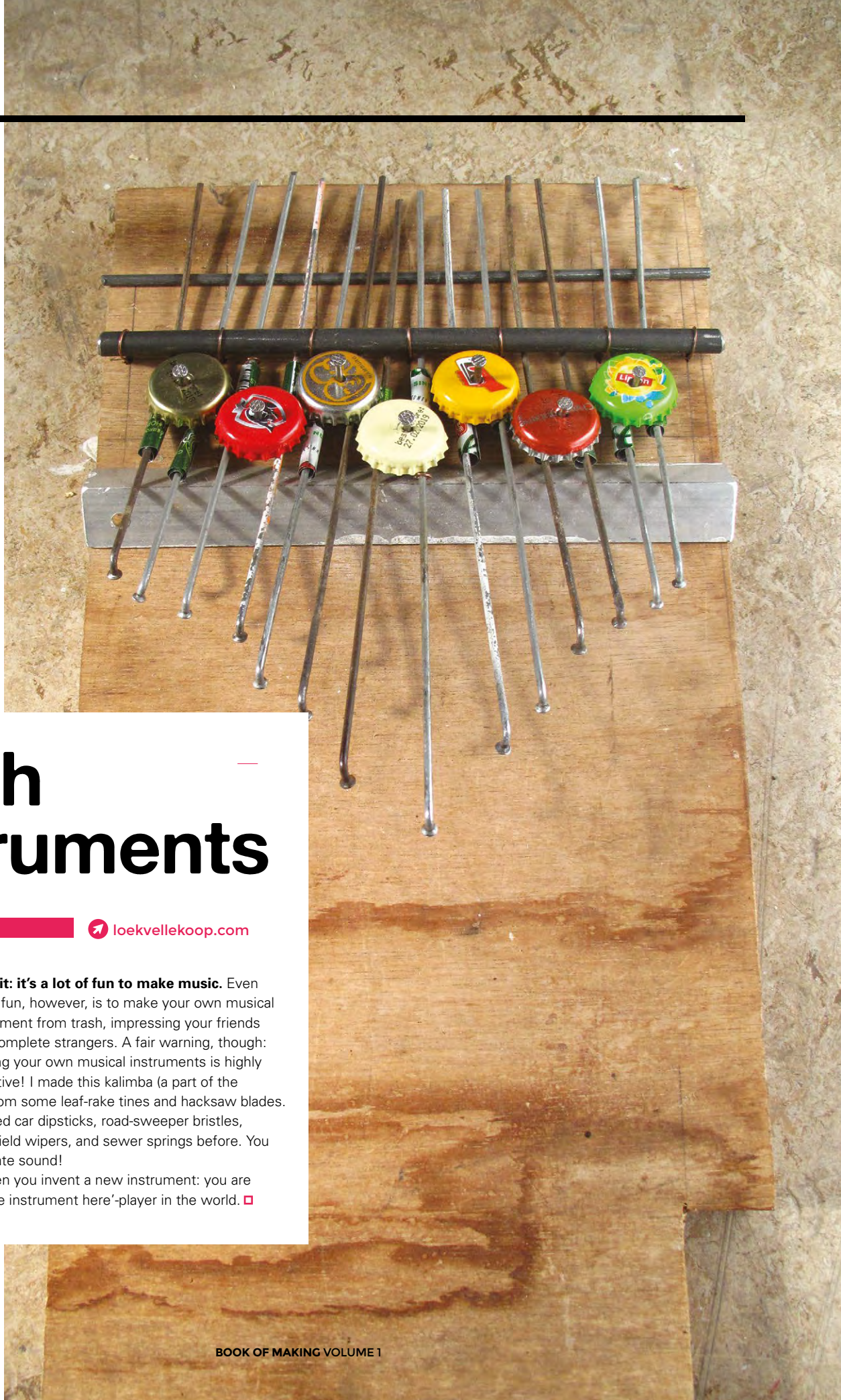

Right 

Loek has made other instruments out of trash, including a gamelan made out of old bike frames – hsmag.cc/sKMUeh

Trash instruments

By Loek Vellekoop

 loekvellekoop.com

Admit it: it's a lot of fun to make music. Even more fun, however, is to make your own musical instrument from trash, impressing your friends and complete strangers. A fair warning, though: making your own musical instruments is highly addictive! I made this kalimba (a part of the lamellophone family) from some leaf-rake tines and hacksaw blades. Alternatively, I have used car dipsticks, road-sweeper bristles, bicycle spokes, windshield wipers, and sewer springs before. You can make anything create sound!

An added bonus when you invent a new instrument: you are instantly the best-'name instrument here'-player in the world. 



NET 14 fl oz / CONTENANCE /
INHOUD / INHALT: 400 mL

THAILAND
Diversity & Refinement
FB (009)

Manchester Robot Orchestra

Why learn a musical instrument when you can build a bot to do it for you?

By Ben Everard

 @ben_everard

Most computers make noise, whether that's the whirr of the fan or the 'grrr-chunk' of a hard drive. Older readers will remember the 'cluck' of a floppy drive and the 'burdung-burdung-beep-chrrrrrr' of a modem connecting to the internet. In general, these noises are unfortunate side effects of the computer doing its work. However, it doesn't have to be like this – the whirrs and clanks can come together to make music. Manchester Robot Orchestra is doing just this, with a collection of instruments made from recycled PC parts, adapted instruments, and just about anything else that can be pressed into service.

We spoke with Dr Will McGenn to find out how this set of instruments came into being.

"It started initially when Professor Danielle George did the Royal Institution Christmas Lectures in 2014. Their big finale was to have a robot orchestra.

"The robots for that came together from various research groups and universities, so it wasn't something that could be kept together – lots of it was actual research hardware and things like that. It had to go back after it was finished. In 2016, Manchester was European City of Science, and that was when the Robot Orchestra really started up in its current form. Initially it was meant as a one-off thing – just for one performance, which we did at the Museum of Science and Industry.

"We played quite a lot of songs with human musicians that day, and since then it's just snowballed. People have been grabbed by it and are really keen. People keep on writing to us: 'come to our event'; →

Right ♦
Musical robots don't have to be complicated

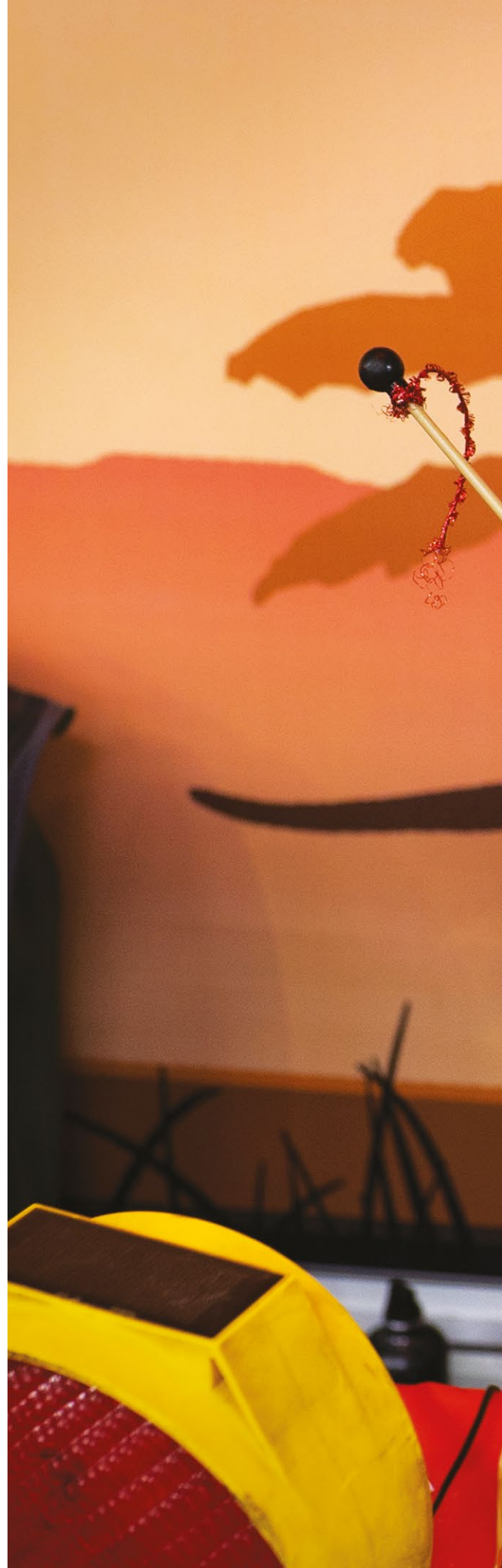

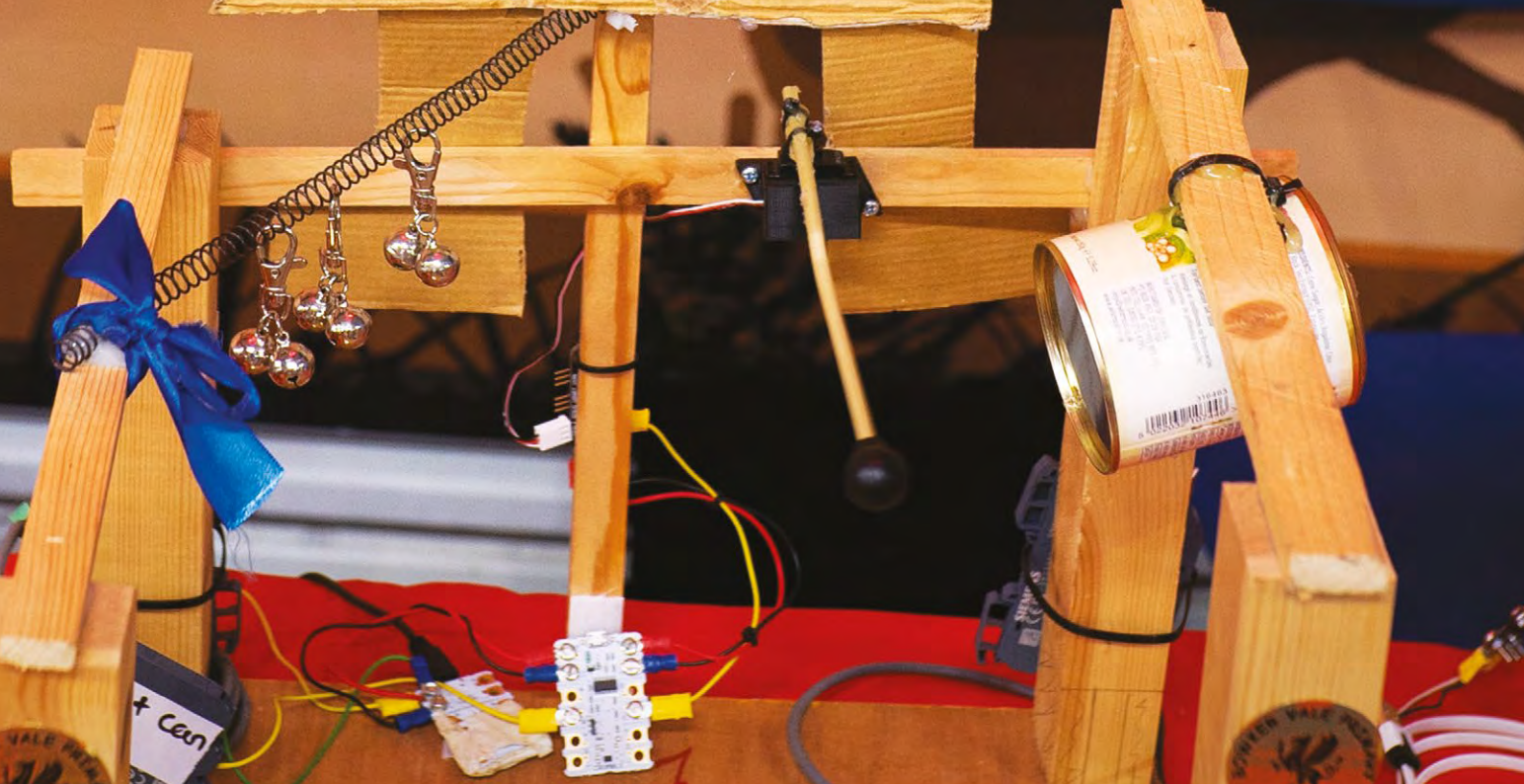
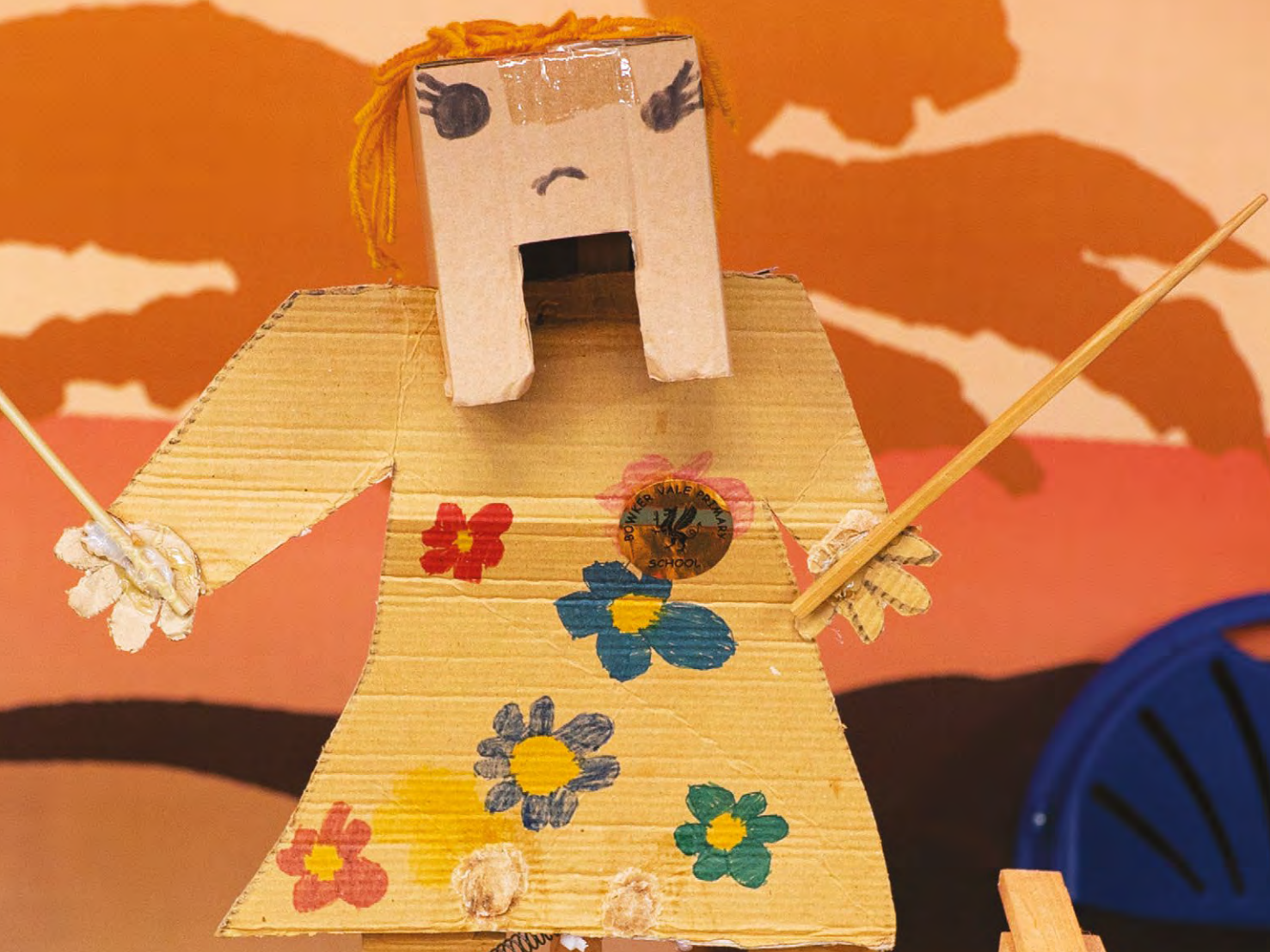

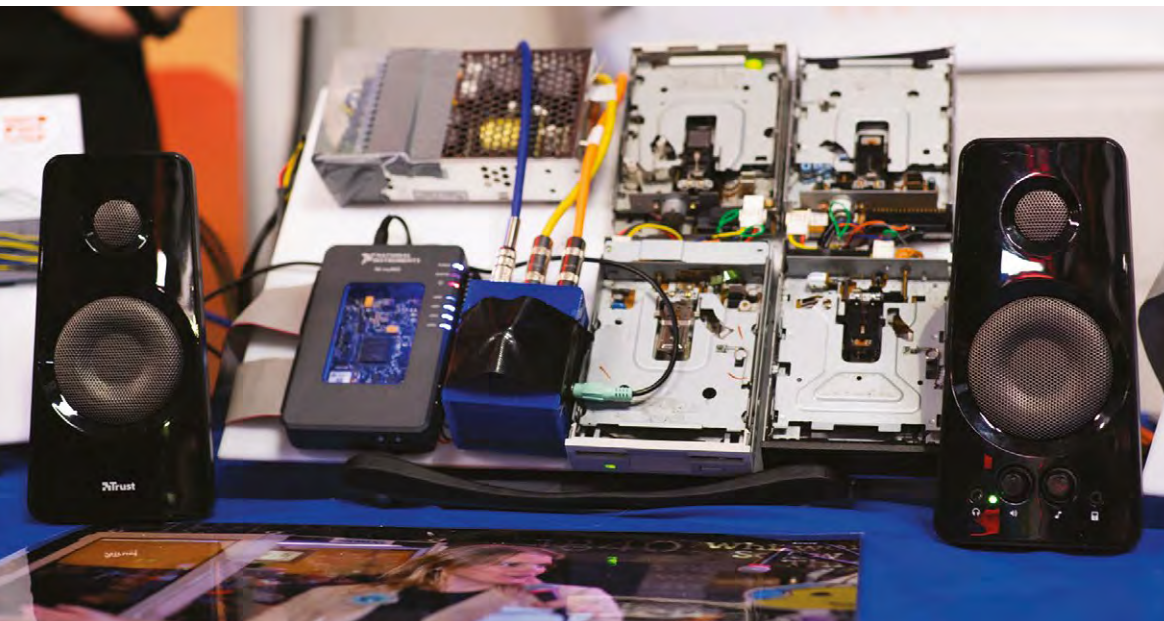
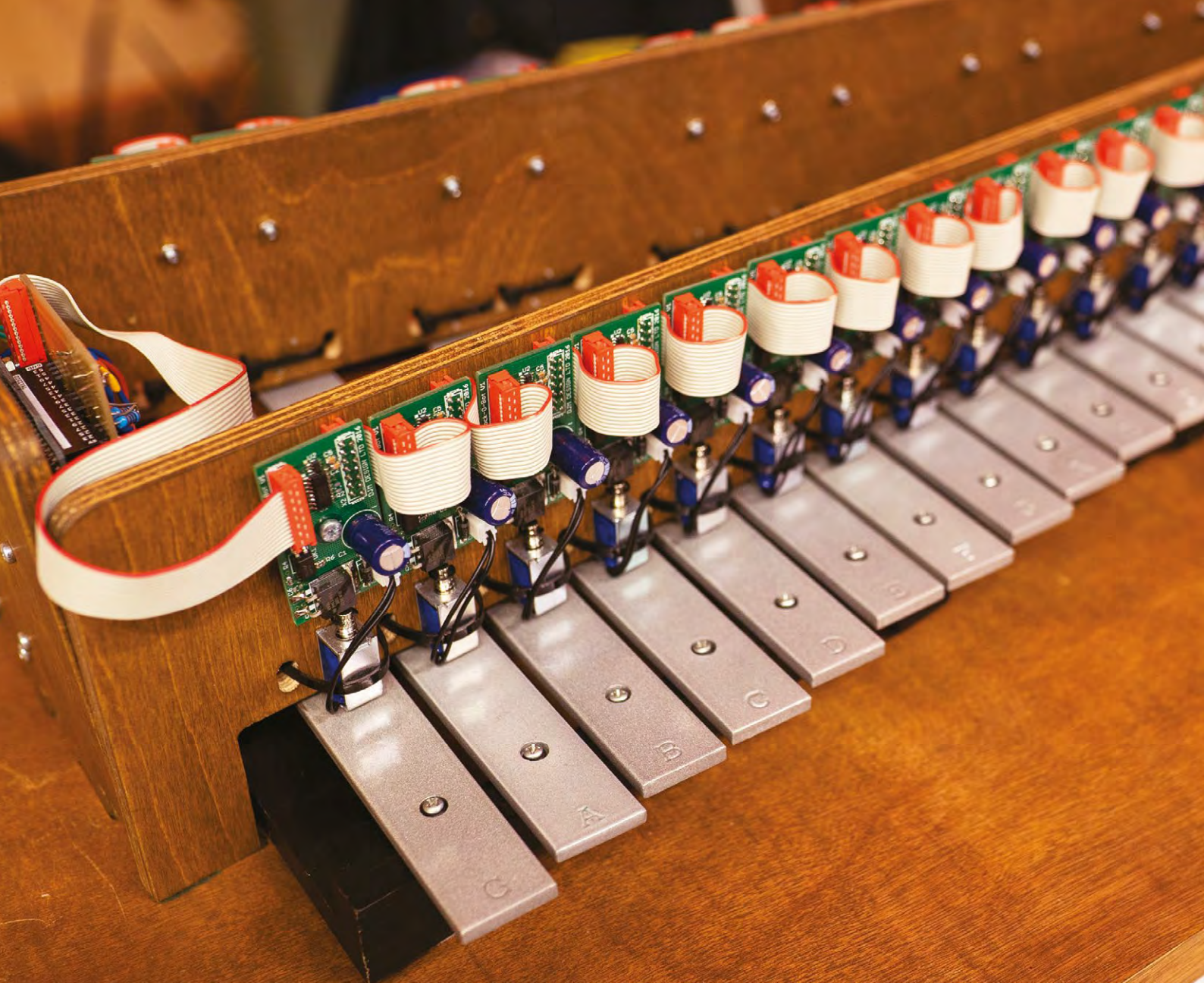

Left ♦
The motors in these floppy drives are rigged up to play tunes

Right ♦
Almost anything can become a robotic instrument, if you have enough imagination





Left ■
Robots aren't limited to just two hands, so can play music of almost any complexity



“// When the orchestra started a couple of years ago, one of the big themes we wanted was **reusing, recycling, upcycling**” //

‘can we do stuff with you?’; ‘can you do this?’. Now it’s just trying to work out how to keep it going, without it still being so intensive from a time commitments [aspect for] volunteering on this.

“We’ve got a team of Masters students working on this Orchestra this year. They’re building a new core of the Orchestra – a new conductor, and a few new instruments and the improvements that’s going to provide will make the Orchestra so much easier to use, and we’ll be able to pass it out to more people. More people will be able to take it out on the road to events like this. Hopefully that will start a whole new cycle of getting kids building new instruments.

“[You program the instruments in] quite a few different ways. We’ve got robots based around quite a lot of different controllers. We’ve got some with Raspberry Pis, some with Arduinos, some that use the little Crumble controllers, which are really simple things based on the Arduino. The Raspberry Pis and Arduinos can take a MIDI file, so a little bit of manipulation to it and [you can] program it onto the Arduino or the Pi. The Crumbles are a lot simpler, so they’re controlled a lot more from our robot conductor. Each time they are needed to play, the conductor will send them a signal.

“When the Orchestra started a couple of years ago, one of the big themes we wanted was reusing, recycling, upcycling. Pretty much all the instruments have been made by school kids – both primary school and secondary school. We’ve got a couple made by university students, but pretty much everything else was made by school kids.

“We’re on social media – just search for ‘robot orchestra manchester’. We put pictures up; we’ve got lots of videos of the different songs as well.” ■

Above ◆
When not making robots play music, Will works on radio telescope receivers



We learn...

GLASS-BLOWING

We make a Christmas bauble – we're going to need a bigger tree...

By Andrew Gregory

 @andrewgregory83

Humans have been creating with glass since ancient times. Not for as long as we've been using wood, stone, or metal, but they're naturally occurring, and our ancestors could get them from the world around them.

Unlike those materials, glass needs to be made before we can make anything out of glass.

It needs high temperatures, the right materials, a load of skill, and a combination of things to go right if you're not to end up with a load of, well, broken glass.

We were lucky enough to have a go at glass-blowing, thanks to Hen Ogledd Glass (henogleddglass.co.uk), a team based in Cumbria who are keeping this ancient craft alive, taking it to the people, and creating some unique handmade pieces along the way. Josh and Ann started their own studio only recently, after training at the University for the Creative Arts, and working with master craftspeople in Somerset and Devon.

WE ARE GLASS

We start with the raw materials. In this case, that's premade glass pellets, as Hen Ogledd's Ann explains: "We buy in our raw, plain glass in pelletised form. When the glass is made from its raw chemical constituents, it takes around three days of

heating at 1600°C. Then you've got to let that sit so all the bubbles rise out, to ensure it's in the same condition throughout. We have a mobile furnace, so if we did it that way we'd have to be here three days in advance, burning gas 24/7." This speeds up the work, but glass is such a good insulator of heat that, even at 1200°C, it takes three hours to get the glass up to temperature.

After the furnace, the tool you'd most obviously associate with glass-blowing is a metal tube, called the iron. The first step is to dip the iron into the molten glass that's sitting at the bottom of the furnace. This comes out glowing reddish-orange, and you have to keep twisting the iron in your hands to stop the molten glass dripping onto the floor, like honey on a spoon. We take a deep breath and try to squeeze some air down the tube and into the glass. Then we try again, but this time harder; the glass is molten, but it's still viscous and heavy, and the first breath in takes a lot of effort to break the surface tension and introduce a bubble into the glass.

Now it's time to add the colours. These come as granules of broken glass, into which we dip the molten glass in the same way you'd put breadcrumbs on a bit of meat to make schnitzel, first on one side to add the yellow granules, then on the other to add the green. This isn't as simple as it looks, however... >



Above ■ Glass has been found dating back from the Minoan Bronze Age, Ancient China, Rome, and Israel. This example was made in Newcastle in 2018, by me



Right ♦

The furnace reaches 1200°C, but it's cool enough to touch on the outside – perfect for warming up a pasty for breakfast

“ EACH DIFFERENT TYPE OF GLASS HAS A DIFFERENT CHEMICAL COMPOSITION, SO IT EXPANDS AND CONTRACTS AT A DIFFERENT RATE ”

Below ■

There are other ways of adding colour, other than granules. Solid rods of different colours are also used, but, as they're so dense before they've been worked, they all look the same – black

“To make colour, they add metal oxides to clear glass,” says Josh, the other 50% of Hen Ogledd. “The pink colour is made with gold oxide – it's really expensive. White used to be made with arsenic but it's now made with tin; blue comes from iron oxide. When you add the colours, it changes the quality of the glass, so the stuff we buy to add colours has to have guaranteed compatibility.

“Each different type of glass has a different chemical composition,” explains Josh, “so it expands and contracts at a different rate. We work with glass that's 96 coefficient of expansion (COE), which is 96×10^{-27} .

“If we were to mix this with bottle glass, that resultant mixture would break, no matter what the rate at which we cooled it down. Because the glass we use contracts as it cools at 96. This contracts as it cools at something like 30, so as the bottle glass molecules contract, they move; these stay in the same place, and that causes internal stress. The forces get so much that it will just explode. If you hold a piece of glass up to a polarising light, you can sometimes see the stresses inside, like petrol on the surface of a puddle of water.”

The granules stick to the molten glass, but they need to go back into the furnace so that they themselves can melt onto the surface of the glass blob. Still turning it round so that the glass doesn't drip, the iron goes back into the furnace, then comes out when the coloured granules have reached the same consistency as the rest of the glass.

GLASS OF MANY COLOURS

At this point, all the yellow is on one side, and all the green is on the other side; now it's time to swirl the colours around to get a pattern that will look good on your Christmas tree.

Hen Ogledd uses a chair with a flat arm, which can be used to roll the iron back and forth at a constant speed. Keeping the glass moving, we spin the iron with two hands and grab hold of the end of the glass with a pair of tongs (yes, this takes three hands – beginners always need help with everything). The twisting motion gives the glass →





Above  The first bit of air is the hardest to get in to the glass – once that's in there, you can put your thumb over the end of the iron and let the hot air expand



Right ♦ We used this tool, called a block, to shape the glass; earlier in the day Josh was using a wad of damp newspaper

the swirls and mixes up the colours. It's a hypnotic motion that looks like toffee or fudge being folded, and looks like we can lean forward and lick it. Obviously that would result in significant injuries, so we resist.

So, the glass literally looks good enough to eat, but it's still not right:

"With the colours being based on metal oxides, they change colour when they get hot, which is really annoying. So oranges, yellows, and reds all go to a red/black. Blues tend to go to pink and greens stay the same, funnily enough. Whites go clear, and blacks just get blacker and redder. So you can't actually tell the colour of the piece until it's cooled down."

KEEPING THE SKILLS ALIVE

Given Britain's role in the development of glass, it may surprise you to learn that the raw materials and the gear used by today's glass-blowers come from all over the world – anywhere but the UK, it seems. The plain pelletised glass Hen Ogledd uses comes from New Zealand, and the coloured granules are made in Germany. The specialised glass-blowing tools are from Sweden, and the hand tools are from the USA – all over the place, as Ann explains:

"We used to have one of the best toolmakers in the world in the UK, but unfortunately he never took on an apprentice, so when he died, his skills went with him.

"That's one of the reasons why we want to share what we're doing as much as possible. We've got this situation where we're losing techniques because people haven't shared them. We're of the view that we may as well share the knowledge and then it will live longer."

Right ♦ You can see the colours swirling through the glass as we hold on to it while twisting the iron

Another quick blast in the furnace and it's time to give the bauble its final shape.

GREAT BALLS OF FIRE

Now comes our favourite bit: smoothing the glass and shaping it to a perfect orb. This uses a specialised tool that's a block of wood with the shape of a round cavity carved out of it, with a handle, and it lives in a bucket of cold water, for reasons that will become obvious. The hot glass goes in the wooden cavity, the iron spins, and a big cloud of steam comes up from the damp wood:

"When the wood burns it creates a carbon layer, which doesn't stick to glass at all. And because it's wet it creates a kind of cushion around the glass. For more complex shapes, we'll use wet newspaper,





Left ♦
Ann demonstrates proper use of the jacks, a tool for cooling specific areas of the hot glass

which gives you more control, but as it's only a little touch here and there it doesn't burn – it just gets a bit warm."

HOT AIR

This next bit requires someone who knows what they're doing in charge, so Ann takes over spinning the iron. We just get to do the essential step of filling the bauble with air. One deep breath and the bauble grows to grapefruit size as Ann spins it to make sure it stays round. Now the thing that we're making looks like other things that people have made, which is a good sign. It's time to get the bauble off the iron, but working with glass requires its own logic. Rather than cut the bauble off, we use a tool called a pair of jacks – they look a lot like a pair of shears, with a handle in the middle and two blades that cut into the glass. This looks like it's cutting, but in fact it's cooling the glass at a place we can control. This makes it brittle at that point, which means we can break it off.

"To take the piece off the iron we have to make what's called a necking line, which is where the glass will break away. If we don't put that line in, it either stays attached to the iron, and then it ends really badly, or it will break off in completely the wrong place and the piece that you've been just been working on for an hour and a half will break right down the middle."

Ann adds a blob of molten glass to the top of the bauble to make a loop and that's the thing complete. Sadly, I can't put it in my pocket and take it home, because it's still soft, and it's still hot enough to melt my skin.

“ WHEN THE WOOD BURNS IT CREATES A CARBON LAYER, WHICH DOESN'T STICK TO GLASS AT ALL, AND BECAUSE IT'S WET IT CREATES A KIND OF CUSHION AROUND THE GLASS ”

"Once the glass is made, we have to put it away in the kiln, overnight. Even though it looks hard, it's still around 500 degrees. Between 500 and 380 is where glass actually forms its structure; it's called a neolith. If you wanted to blow some glass and then just leave it out in the air, it would be very susceptible to temperature changes, because the structure of the glass would have stresses in it.

"If you imagine a bauble, inside it's going to stay hotter than the outside. The outside is going to cool faster than the inside, it's going to contract while the inside is going to stay the same, which will introduce stresses into the glass. So we have to bring it down nice and gently so it forms properly. We bring it down by around 30C an hour, which means it cools nicely, the glass forms with little to no stress in it, it's stronger and it can take temperature changes."

Our final piece is surprisingly heavy, and seems to look different every time we pick it up. It's not perfect but it's ours, and it's a living link back to methods that have been used for thousands of years. □

Below ♦
An extra blob of plain molten glass to form a loop, and our bauble is complete. Not bad for a first attempt



We learn... to make a leather belt

FEATURE

We learn...

TO MAKE A LEATHER BELT

Keeping our trousers up the hacker way

By Ben Everard

The M5 runs straight up the Severn Valley while the river snakes around on the left. The hills of the Forest of Dean rise up on the west side while the Cotswolds escarpment dominates the skyline on the other. There's just

time to stop to pick up some cave-aged cheddar at Gloucester services before my evening appointment.

My satnav takes me safely through Cheltenham's infamous one-way system to an inauspicious industrial estate on the outskirts of town, and a Hackspace 'H' identifies the Cheltenham Hackspace.

Inside, the members' storage in the porch is dominated by 3D printers, and this leads into the electronics section of the Hackspace where a few members are busy at work on a LED cube. Upstairs, there's space for textiles and computer work. I meet Tim, Cheltenham's leather-work guru and my instructor for the evening.

Tim explains that quality leather-work starts with quality leather, and a significant part of that comes from the treatment that the material has received. Much consumer leather is made with low-quality and cheaper leathers such as chrome tan. When



Right  A glowing H just to remind everyone what sort of building they're in

“ Tim opens a box of leather tools, and the **contents looks disturbingly like** they might have been designed for a Victorian dentist. ”

you're making your own leather goods, you can use whatever quality you like (or can afford) and we're working with veg tan, which feels much thicker and sturdier than leather goods I've bought previously. This ability to bring the quality of leather you want with the design you want gives the maker a far greater range of leather options than someone buying off-the-shelf options.

As a brewer, Tim's particularly interested in tankards – mugs for drinking beer. These are first cut and sewn together, then dipped in molten wax which makes them waterproof and strong.

After showing off what's possible with the skills of an experienced craftsman, it's time for me to find out what's possible in the hands of an inexperienced journalist.

Tim opens a box of leather tools, and the contents looks disturbingly like they might have been designed for a Victorian dentist.

Belts are fundamentally a fashion item (otherwise we'd just hold our trousers up with string), and

Below ■ Our finished belt is strong enough to hold our trousers up despite the Christmas indulgences...



Above ◆ Keeping all the dust-generating tools in one room helps keep the rest of Cheltenham Hackspace clean and tidy

as such, much of the evening is taken up with decorating. Including a stitched effect around the edge of the belt and some embossing – I opted for a rather (in my opinion) tasteful oak leaf and acorn motif. You can see the complete process overleaf. Nothing is fundamentally difficult, but it does require a few specialist tools and a knowledge of how to handle the leather, including treatments,

The pay-off/difficulty ratio for belt making is quite high. In a few hours (with instruction) I was able to make an item of clothing I'm proud to wear despite having no experience in the field. This alone makes it a great area for makers. →



MAKING A LEATHER BELT

STEP 1 CUTTING THE SHAPE

Using a strap cutter, create a strip of leather the right width for your belt buckle



STEP 3 SHAPING THE LOOSE END

Cut the loose end of the belt into whatever shape you want, such as a rounded point

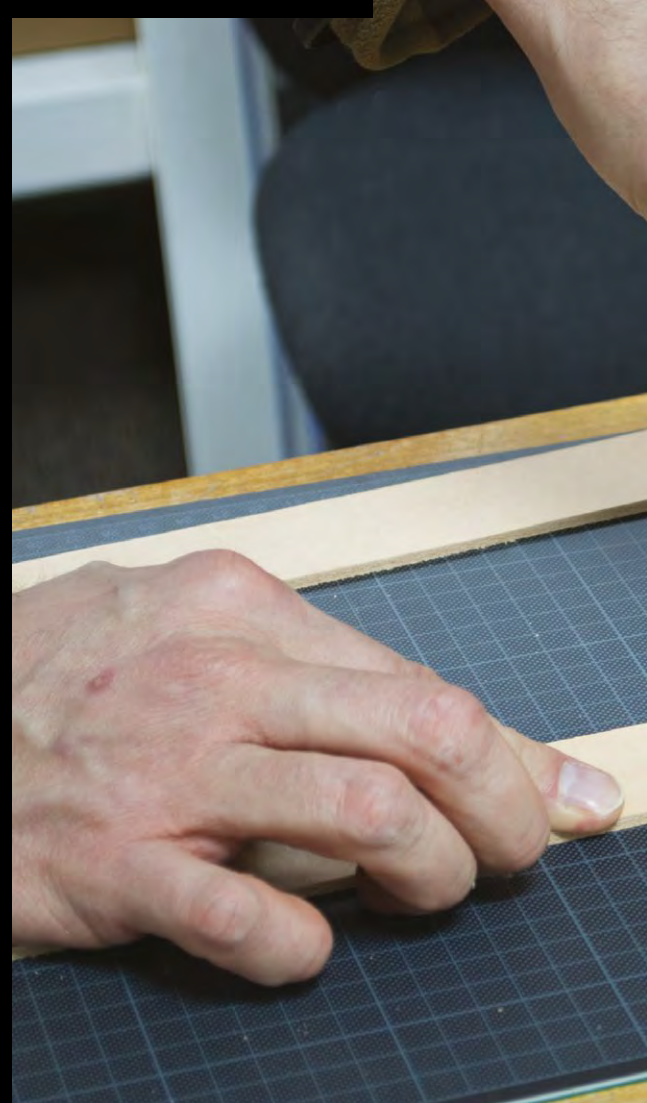

STEP 2 MEASURE THE LENGTH

Ensure your strip is long enough to fit once it's been turned into a belt



STEP 4 GROOVING THE EDGE

Use a groover to create an indentation in the leather along both sides of the belt

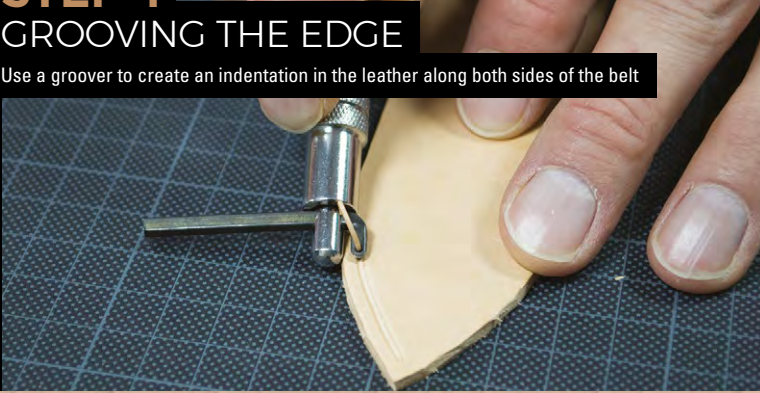

SADDLE STITCHING

While most of belt making is cutting and designing the leather, there is one skill that you'll need: saddle stitching.

The first thing to do is punch holes in the leather that the needle will go through. As this is done before the needles get anywhere near the leather, there's no need for the needles to be sharp, so leather needles are blunt. Ensure that your leather is lined up properly before starting or it'll end up wonky.

Perhaps the most unusual thing for someone who sews is that you'll need two needles threaded on the same thread. We'll name our needles 1 and 2. Start at one end of the row of stitches and push needle 1 through the first hole and needle 2 through the second (both from the same side). You should now have a single stitch on one side of the leather with the thread coming out of two holes on the other.

Now, push needle 1 through the hole that needle 2 just came out of – this should complete a loop of thread and you can pull it tight. Push needle 2 through the next hole up and you should once again have both ends of the thread coming out of the same side of the leather. You can now repeat this pattern until you have completed the row of stitches.

You'll need to stitch back over the row a few times to make sure that the join is secure. Each time, you should find that it gets a bit tighter as the thread fills in the hole. Once it's strong and secure, you can simply trim off the ends of the thread and the join is complete.



STEP 5 'STITCHING' THE EDGE

Run an over stitching tool along the groove to create the impression of a sewn edge



STEP 6 PUNCHING THE HOLES

Punch holes at 3 cm intervals along the tail end of the belt. You also need a larger hole in the other end to fit the buckle through



STEP 7 EMBOSSING THE LEATHER

Wet the area to be embossed, then with a single mallet-blow, use the punch to create an impression in the leather

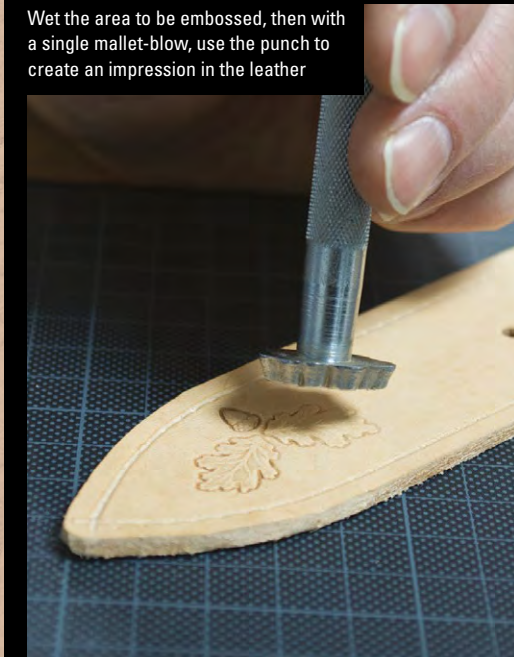

STEP 8 OIL THE LEATHERS

Add whatever treatment you want to preserve and colour the leather. I opted for a simple oiling



STEP 9 CREATE A LOOP

Cut a rectangle of leather about 5mm wide and long enough to wrap around the belt (including the tail of the belt)



//

In a few hours (with instruction) I was able to make an item of clothing I'm proud to wear

//

STEP 11 BURNISHING THE EDGE

Add burnishing compound and rub using a rounded wooden tool to hold the fibres in the edge together and give it a sleek appearance



STEP 10 SEWING THE LOOP

Saddle-stitch the two ends of the rectangle together to create a loop



STEP 12 ATTACHING THE BUCKLE AND LOOP

Place the buckle in place and fold the leather round. Then punch holes to stitch the two layers of the folded leather to hold the buckle and loop in place. Saddle-stitch through these holes to hold everything together. You've now finished your belt





Bike trailer

By Carolyn Ryves

 @CazRyves

A

lot of my projects involve bicycles, and using them to power different appliances/inventions – everything from boom-boxes to paint-spinning machines and bicycle bingo.

The idea of the wagon was to create a fun trailer that I could store a pedal-powered sound system in, and use to transport it locally to events to power music or a small street-based open mic.

So this was really the start of the project... my next part is to turn some old suitcases into speakers – and maybe try to make the bicycle look like a horse!

Someone donated their old bicycle trailer to me and this was the foundation and original inspiration to build from. The sides and main frame were made from scrap ply and other offcuts of wood, and the doors were cut out from panels of my old childhood wardrobe! The support for the canopy cover is made from blue water pipe, and the canopy was made by dyeing an old curtain and attaching it to a camping groundsheet so it is waterproof... I'm a fan of using scrap and recycled materials and seeing where they lead me. (Sometimes, to an endless pit of despair!) 



Right  Carolyn's bike trailer was upcycled from old bits of wood including wardrobe doors



REVIEWS

HACK | MAKE | BUILD | CREATE

Expert reviews of the best kit, along with fun projects created using inexpensive imported components

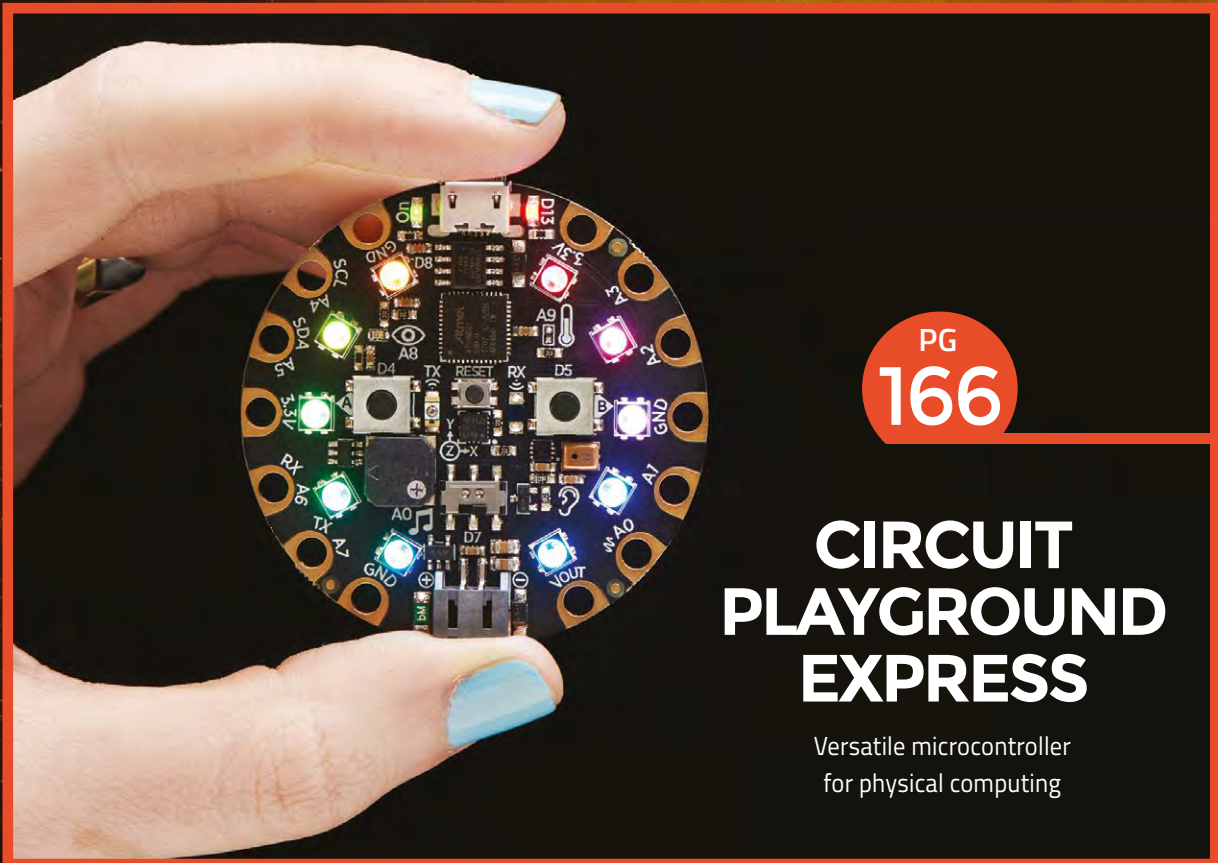

PG
166

CIRCUIT PLAYGROUND EXPRESS

Versatile microcontroller
for physical computing



PG
168

SPARKFUN INVENTOR'S KIT VERSION 4

Ideal for electronics beginners

STIRLING ENGINE BUGGY

Convert heat into motion with a simple external combustion engine

PG
172



PG
170

CRAZY CIRCUITS

Helping young makers learn basic electronics

PG
174

HYDRO- PONICS

The quick and easy way to get a fresh salad

PG
176

LASER HARP

Play tunes with a flick of your finger

Circuit Playground Express

\$24.95 / £25 | adafruit.com (US) / pimoroni.com (UK)

By Ben Everard

 [ben_everard](https://twitter.com/ben_everard)

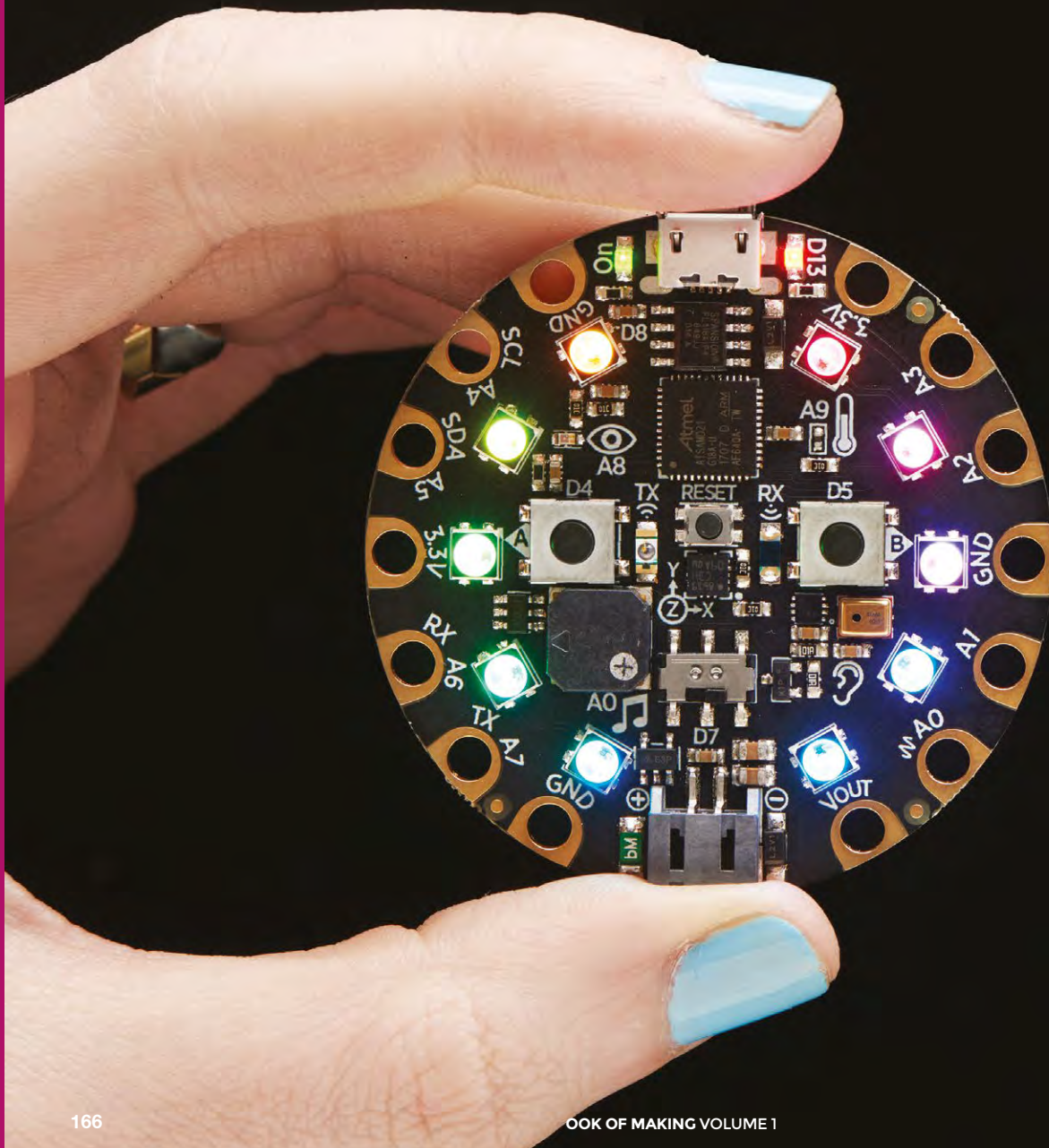

The Circuit Playground Express (CPX) is a programmable microcontroller board that makes it really easy to get started.

Plug it into a computer with a micro USB cable and you're ready to start coding.

The UF2 firmware takes software into

the board in two ways: either you can press the reset button to enter programming mode and copy UF2 files into a new drive that will appear on your machine, or you can upload directly from the Arduino IDE. For beginners the first method will be easier, as you can generate these UF2 files from either the web-based MakeCode block-based editor or from a Circuit Python development environment.

On some versions of Windows, you'll need to install drivers, but on macOS, Linux and Windows 10, you don't need to install anything if you use MakeCode – just plug your board into a USB port, then point your browser to makecode.adafruit.com to start your first project.

BUILT-IN FEATURES

From here you can take advantage of the wide range of hardware that's packed onto the board. For output, there are ten NeoPixels and a speaker (not just a buzzer).

For input, there are two buttons, a slide switch, an accelerometer, a temperature sensor, a microphone, and a light sensor. With all this, you can put together some pretty fancy projects straight away. For our first project, we made an indicator for cyclists. It uses the large holes on the CPX to attach it to the back of a cycling glove, then uses the accelerometer to recognise when the hand is held out indicating a turn and flashes the NeoPixels orange. This took 18 lines of dragged-and-dropped code in MakeCode and no additional hardware (most of these were to ensure that there was a stable reading from the accelerometer). While it's hardly a complex project, it shows that you can build useful projects quickly with no additional hardware or software.

There's nothing on the Circuit Playground Express that's fundamentally unique – you can get the same sensors and outputs to attach to virtually any microcontroller. What makes this board special is the way it's brought together into a single package. It's hard to think of any project where you'll need all the features available, but given the £25 price tag, it's easy to justify the cost even if you only need one or two of the extra input or output options. By bringing them all onto the main board, there's no extra setup or wiring, and it's all supported by the software without having to add any libraries, which again makes it thankfully easy to get started.

The one obvious thing missing from the device is any form of networking. It does have a built-in infrared

receiver and transmitter, I²C and UART, but no WiFi or Bluetooth. The other major limitation of the board is that it's not breadboard-friendly – it's far more suited to crocodile clips or banana plugs.

MANY, MANY POSSIBILITIES

Whether or not these are really limitations depends a lot on the sort of projects you're working on. The CPX isn't going to work well for Internet of Things-type applications. It's also not going to work well as a controller for building complex circuits – having just eight GPIOs limits the amount of hardware you can connect. Anyway, there are lots of microcontroller boards far more suited to these uses. However, the CPX makes it fantastically easy to get started with embedded and physical computing projects. You can build on the integrated hardware with the eight GPIOs. Seven of these can detect capacitive touch input, so to add more user input to your project, you just need a few crocodile clips and leads. As all the GPIOs can read analogue input, it's also trivial to add input from and device that gives a varying voltage as it's output. There are also five PWM output pins for driving LEDs



The CPX is well suited to people getting their first microcontroller, either buying one themselves for fun or as part of a taught course



at different brightnesses. The MakeCode platform is a code repository as well as an IDE, and there are a set of tutorials from Adafruit to help you get started with the platform and the hardware.

The CPX is well suited to people getting their first microcontroller, either buying one themselves for fun or as part of a taught course. For this purpose, it's genuinely hard to fault the CPX. It's easy to learn with no (or minimal) software to install, yet at the same time allows you to use more advanced languages if you've got the knowledge and experience. It packs a fantastic range of input and output options onto the board, which means that you can dive right into some more interesting projects without getting immediately bogged down in attaching extra hardware. It's also easy to start to build simple circuits off using crocodile clips.

Perhaps the ultimate test of any bit of hobbyist kit is whether or not it sparks excitement. For us, the CPX gave us a childlike sense of glee, because it makes so much so easy. This is great for beginners and any hobbyists who like to quickly prototype projects. □

VERDICT

The best microcontroller board for introducing people to physical computing projects.

10/10

SparkFun Inventor's Kit version 4

\$99.95 | sparkfun.com

By Ben Everard

 ben_everard

The SparkFun Inventor's Kit (SIK) is an electronics set that comes with a guide-book and a storage box for keeping everything tidy. The kit is set up around the SparkFun RedBoard which is pretty similar to an Arduino Uno R3. As far as most beginners are concerned, it might as well be an Arduino Uno – you program it in the same way and the pinouts are the same. There is a version that comes with an Arduino Uno R3 for an additional \$10.

Below  Keeping our electronic components tidy is a constant struggle for us – the SparkFun Inventor's Kit gets you off to the right start



Alongside the RedBoard, there's enough bits and pieces to complete a range of projects. It's clear that quite a bit of thought has gone into the balance of this kit. There are bits to display information (LEDs, LCD display), bits to get data (ultrasonic sensor, potentiometer, and temperature sensor), bits to make things move (motors and a servo), and associated bits (resistors and motor drivers).

Along with the electronics bits, there's a breadboard which allows you to assemble circuits without having to solder them together and, once you're finished, everything comes apart and you can reuse the bits in your next circuit. Together, there's almost everything you need to make the projects in the guide (you'll also need scissors, pliers, four AA batteries, and a paper clip).

It's the guide-book that really sets the SparkFun Inventor's Kit above the many other electronic component kits that we've seen. It includes a basic setup guide and then five projects, each of which includes three or four circuits as well as suggestions for different ways you could modify the build to take it in different directions. The guide is available online at hsmag.cc/NyzLmA.

The projects start with the classic blinking LED and build up to a wheeled robot that navigates the world by itself. If you complete these and are still looking for more, there are also some additional resources at hsmag.cc/uMJoEj.

The guide is well laid out and easy to follow. It includes explanations of the different concepts and components that you're using, so it's not just a list of steps that you complete in turn. There's also trouble-shooting advice for when things don't work, and suggestions for extending each project.



Above  The selection of parts is well thought out to give you experience with a range of different components

We would have liked to have seen a little more coverage of the programming side of things in the guide. The code for all the projects is downloadable and, while the electronics side of things is well explained, the guide goes into less detail about how to program. It does explain the key concepts, and important bits of code, but a little more detail on how to create programs would – in our view – help readers with no background in coding. Perhaps we’re being a little pedantic here because it is a beginner’s kit, and as such it can’t cover everything. What it does cover, it covers well and interested users could, no doubt, find more information about Arduino programming that they can use alongside their Inventor’s Kit.

While all the components are straightforward to use, there’s nothing specifically ‘beginner’ about them. They’re the same components that are used by experienced makers, and assembled in the same way that most people prototype their projects (on a breadboard).

Because there’s no proprietary gubbins or secret sauce in this kit, there’s not really a point where you outgrow it. You’ll probably find that you want to add more bits to it, but there’s a wide range of breadboard-compatible components available from just about every hobbyist electronics store on the planet that will work seamlessly with the bits in this kit (the only caveat is that they need to be 5V-tolerant to work with the RedBoard (or an Uno) – parts

designed for a 3.3V board like a Raspberry Pi may not work successfully.

If you decide that you want to try out a different controller to the RedBoard, you can work with anything else that will connect to the breadboard (which is most things). In this way, the SIK isn’t so much a beginner’s kit, as the start of your collection of electronics bits and pieces. We feel it’s only fair to warn anyone reading, and looking to get started in electronics, that these collections have a habit of growing at a faster rate than the available space. It starts with a nice neat collection in a tidy plastic box and soon you’ll be wondering if you need to build a new shed.

SparkFun claims that the SIK is suitable for anyone aged ten or older. Obviously everyone’s different, but broadly this seems about right to us. It’s a bit fiddly and doesn’t obfuscate the details, so many children younger than this may struggle. However, there’s nothing particularly childish about it and it could equally be interesting for people well beyond this age looking to get started with electronics.

There isn’t a killer feature of the SparkFun Inventor’s Kit, but it is well thought out, comes with a great guide, and is easily expandable as your experience and knowledge grows. 

VERDICT

A well-thought-out kit for anyone getting started with electronics.

9/10

Brown Dog Crazy Circuits

From \$50 | browndoggadgets.com

By Ben Everard

@ben_everard

Brown Dog Crazy Circuits is a set of components on breakout boards, designed to help young makers learn the basics of electronics. The breakouts have large circular connectors that you can use to connect up your circuit in a number of ways. The most basic option is using crocodile clips. This enables you to quickly prototype

your circuits. Once you've got everything working the way you like, you can then move on to incorporating this in a physical product in a variety of ways.

The connectors are arranged in the same pattern as the bumps on the tops of Lego bricks, and the kit includes the connectors needed to wire up your brick-based masterpieces. The Lego connections work with braided tape made of nylon, nickel, and copper. This runs along the Lego bumps and, when a component is pressed down into place, the metal pad on the breakout board is held against the tape, creating a connection. Using this tape as wire, you can connect up any circuit. The large holes also work well with conductive thread and you can sew the components into fabric for wearable designs.

WHAT'S IN THE BOX?

The basic set of Crazy Circuits comes with battery holders, LEDs, a blink/fade, and the bits needed to connect all this together for \$50. The Deluxe set includes a whole lot more components, including the Touch Board, which gives you some programmable control. This kit comes in at \$200.

The Touch Board is a Teensy LC broken out into the Crazy Circuits-style board, so it works with crocodile clips, Lego, and conductive thread. You can program

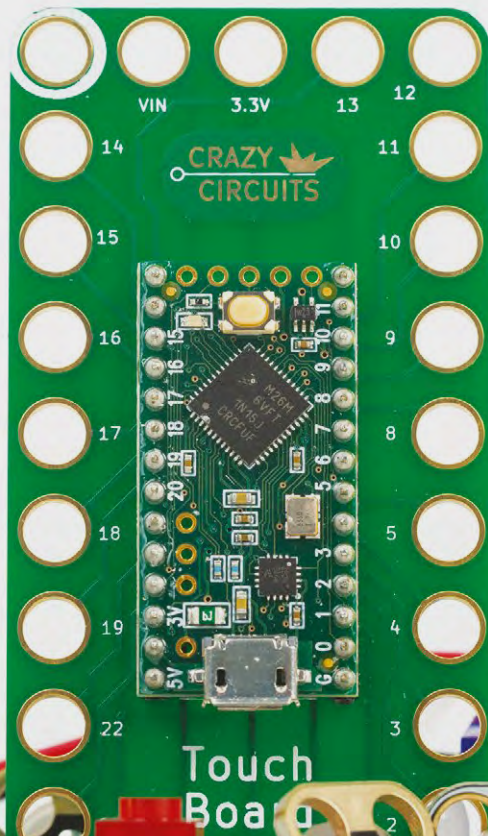

Right

The broken-out Teensy LC gives plenty of processing power to your projects

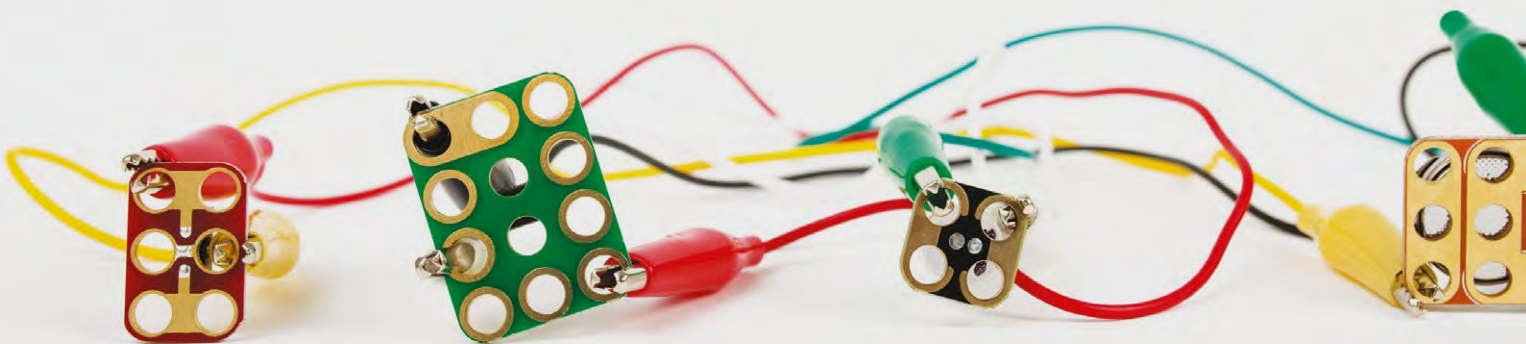

Above  Crocodile clips are the easiest way to prototype with Crazy Circuits

this via the Arduino IDE in the same way you can any other Teensy board. It's powered by an ARM Cortex-M0 processor, which should provide enough power for most maker projects.

As the name suggests, the pins on the Touch Board can take capacitive touch input on eleven of its pins. This gives you a wide range of options for manipulating your builds with your fingers.

Perhaps the most exciting kit for us is the Robotics Kit (\$150) that comes with a broken-out Arduino Nano and a set of Lego-compatible servo brackets for the four servos (two continuous rotation). This gives you quite a powerful set of tools for automating things you've made with Lego.

KEEP IT SIMPLE

Brown Dog also makes kits with squishy circuits, sewable, robotics, conductive paint, and others, but these are built on the same technology as the other kits.

We'd love to have some networking options, as this would give you options for building an IoT (Internet of Lego) network. There are some pins available via male headers, which does give you the option to hook this up to, for example, an ESP8266 for network access, but this adds another level of complexity to your projects.

None of the methods for working with Crazy Circuits is particularly suitable for complex schematics. Whichever method you're using, (crocodile clips, Lego tape or conductive thread) tends towards chaos as you make more and more connections. This is the price paid for circuits that integrate well with Lego and clothing, and it's a price worth paying for getting young people excited about intermingling electronics and physical things.

Crazy Circuits may look expensive when compared to electronics kits that come with just bare components, such as those for working with



Above  The storage box keeps everything tidy when you're not using it

breadboards, but this extra expense is justified by the extra options that the form-factor allows.

While the Crazy Circuits hardware is all based on existing technology like the Teensy LC and Nano, it's great to see that Brown Dog has put together a comprehensive set of documentation specifically for this product. As well as user guides that cover the basics of how to use the hardware, there's a projects section on the website, with a good selection of projects for you to try. These show off the different features and provide a good basis for planning your own projects.

We really like the effort that Brown Dog has gone to to make it easy to work with, from a simple circuit demonstration to integrating this into a device – of course, device in this context is something built by young makers. A simple circuit making an LED flash may not be that exciting on its own, but when it's powering, for example, the lights on top of a Lego police car or making stars twinkle on a Christmas jumper, it's much more attractive to learners. 

VERDICT

An electronics kit with great options for incorporating circuits into physical builds.

9/10

DIRECT FROM
SHENZHEN

Stirling engine buggy

Convert heat into motion with a simple external combustion engine

By Ben Everard

 @ben_everard

In 1816, Robert Stirling created a closed-cycle air engine which worked by heating one side of the engine while the other remained cool. Air in the hot side heats up and expands, and is shuffled through to the cold side where it contracts. This expanding and contracting drives pistons, which in turn drive a fly-wheel which itself keeps the pistons in both sides (the hot and cold parts) moving in synchronisation. It's an external combustion engine in that the fuel and heat source are entirely outside the main engine, in a similar way to a steam engine. However, unlike a steam engine, it's a closed-loop system so you don't need to top up the water (or any other fluid) – just apply heat and you're ready to go.

Typically the hot side is heated by a flame, while the cold side is left to cool to room temperature, though this doesn't have to be the case. Theoretically, the hot side can be left at room temperature and the cold side cooled – provided you can get it cold enough, the engine will still run – or some combination of both heating and cooling.

There are a few different configurations available – the most mechanically significant difference is whether there's one cylinder that holds both the cold and hot sides (beta type), or two cylinders, with one hot and one cold (alpha type). Beyond this, there are dozens of different ways of mounting them, though most are purely aesthetic, including propeller mounts and setups designed to look like an

Right  Despite an unnerving amount of rattling, the buggy can propel itself easily over smoother terrain



internal combustion engine. There are also high and low temperature differential options, with the low temperature differential options needing a much larger surface area on the hot and cold sides (leading to a short, wide cylinder).

We got an alpha-type engine driven by a small spirit burner mounted on a small buggy from the Cassiel Alice store on Ali Express for £30.81, (a wide variety of similar models is available on many direct-from-China sites). The unit came fully assembled, with the engine mounted via a threaded bolt on a short section of U-profile aluminium. A couple of axles support plastic wheels that allow the buggy to move.

A STIRLING EFFORT

We applied a flame and waited. It took around 30 seconds for the engine to heat up enough that a flick of the fly-wheel spurred it into life. The speed of the engine depends on the size of the flame, but we'd put it at between 100 and 500rpm.

The drive system comprises of a couple of gears joined by elastic bands to the front axle. Frankly, it does not inspire confidence. However, it worked and drove our little buggy along at a fairly sedate pace. We have no doubt that this drive system could be improved to power the buggy at a higher speed, but if you're just after movement, this elastic band system does the job.

Unlike internal combustion engines with their repeated ignitions, there's not an inherent source of noise in a Stirling engine, and they can operate very quietly. However, this buggy is quite noisy in operation. This appears to be from intolerances in the fly-wheel and attachments. There's quite a lot of slack and wobble in the system, which causes it to judder about more than this type of engine really should. This doesn't really affect the buggy too much (though it may shortened its life), but it does limit what other projects you could build off this engine.



Above  The burner left one of the cylinders covered in soot, but otherwise the little engine stood up to our testing well

We were slightly disappointed that the spirit burner is difficult to remove – this makes it quite difficult to hack the system to work with a different heat source. Although it's bolted on, the nuts appear to be glued in place, so removing this to allow space for a different burner is difficult. An alternative hack would be to direct the power from the engine into some other mechanism. This should be perfectly possible, and the aluminium base of the buggy could be used as the base of other makes, or simply kept as a mounting for the engine.

Despite these limitations, this Stirling engine is still easy to work with, and in general, Stirling engines are probably the simplest of the mechanical engines to work into a build. They can run at much lower powers than internal combustion engines, and don't have any high-pressure parts liable to explode if pushed to their limits, (as with steam engines). Electric motors might be an easier option, but there's something just undefinably nice about building something with a mechanical engine driven with real fuel. Whether you want it for pure interest, or you're looking to add a steampunk aesthetic to the power source in your next make, Stirling engines are a fascinating option. 

DIRECT FROM SHENZHEN

DIRECT FROM
SHENZHEN

Hydroponics

The quick and easy way to get a fresh salad

By Ben Everard

 @ben_everard

Below 
There's something both
pleasing and a little unnatural
about plants lined up
perfectly in two dimensions



Hydroponics – the process of growing plants by applying liquid nourishment directly to their roots rather than via soil – comes in many shapes, sizes, and varieties.

At our office, we don't have space to create vast amounts of produce, but would like a little fresh salad grown on our windowsill, where the pesky slugs that blight the garden can't get at them. Can the simple kits available from direct-from-China sites help us here?

We turned to AliExpress vendor, Garden World Store, and purchased a twelve-holed bubble cabinet for £24.27. This is one of the simplest methods of hydroponics, where the plants are grown suspended directly in the water, and an aquarium pump keeps the liquid oxygenated. Other hydroponic approaches include trickling water over the roots, or applying a mist to the roots as they're suspended in the air. In principle at least, hydroponic systems should allow plants to grow faster and with less intervention than those grown traditionally. They can also be grown more densely, which comes in particularly useful when space is limited indoors.

PICK OF THE CROP

As we're fairly literal-minded, we decided to test our setup with watercress. Hydroponic systems can grow a wide range of plants, but leafy greens are the easiest and quickest to grow, particularly in a simple system like this. They're also a crop that can be expensive to buy and taste better when fresh, so make an ideal candidate for home cultivation.

There's not too much to the assembly – essentially everything just slots together. To start your crop, first germinate some seeds (place them on a damp paper towel for a couple of days until they just start to grow, then transplant them to a foam plug (included in the kit) using the supplied tweezers). Leave these soaking in a small amount of water until they have three leaves, then fill up the tub with a water and nutrient solution (not supplied), and start running.

There's no clear information on exactly how much bubbling the solution needs, as it's hard to measure the amount of dissolved oxygen in water. It will vary, depending on the power of your particular bubbler, the strength of your plants, and a myriad of other factors, so you'll need to experiment to get it right. We've combined our system with a simple timer switch that runs the bubbler when we're least likely to be near it, (so the noise of the bubbles is less distracting).

As well as water and nutrients, plants need light. We've placed our system on a windowsill that's in sunlight for most of the afternoon, and this is working

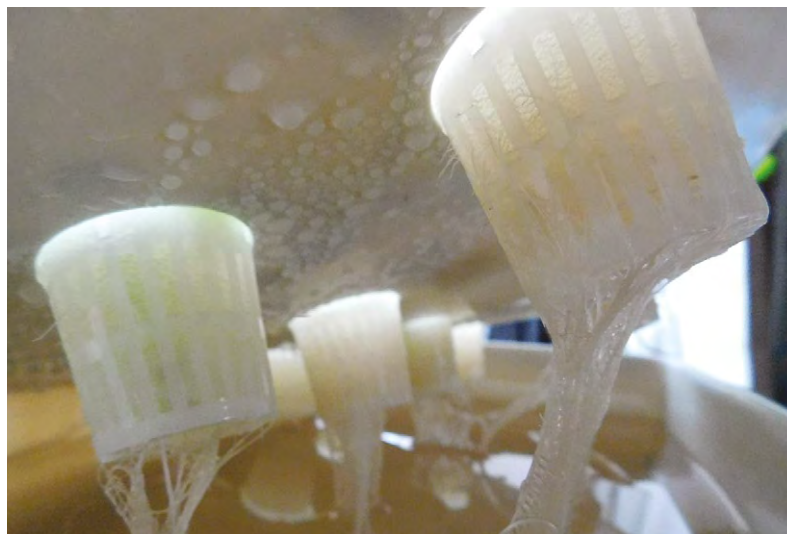

well through summer. If you have less light – or for year-round growing – you might want to partner this system with a grow light to speed up growth. If you do, make sure that you get the right colour grow light for the crops you produce – the balance of frequencies can have a big effect on the plant, positive and negative.

Above  With the lid lifted up, you can see the roots hanging in the water

REAP WHAT YOU SOW

Our setup is running, and we took our first crop just three weeks after planting out. We're using a cut-and-come-again approach, where we harvest some of each plant and leave the rest to keep growing. This should mean that our system will continue to supply us with watercress for many months to come. We've found that now everything is going, there's very little to do. About once a week we top up the water levels, but other than that, we've not had to do anything.

So far, this little hydroponic system has delivered a quick supply of salad in a small space with little effort – exactly what it promised to do. Hopefully it will mean that the days of getting halfway through a bag of salad before it starts leaking brown juice are behind us, and we will now subsist on a diet of fresh, green leaves. Whether this gives us better health for better making is still to be determined.

The hydroponics setup is made from cream-coloured plastic that does let a little light through (as opposed to the black plastic of many more expensive hydroponics setups). This hasn't caused any problems for us, however, though it could lead to a build-up of algae in the tank over prolonged usage.

In the world of hydroponics, our setup is tiny, both in terms of the size of plants it can support, and the number of them. This is perfect for a few salad leaves, but it'll struggle with larger plants. Make sure that you match the hydroponic system you get to the crops you want to grow to avoid disappointment. 

DIRECT FROM SHENZHEN

DIRECT FROM
SHENZHEN

Laser harp

Play tunes with a flick of your finger (no sharks required)

By Ben Everard

@ben_everard

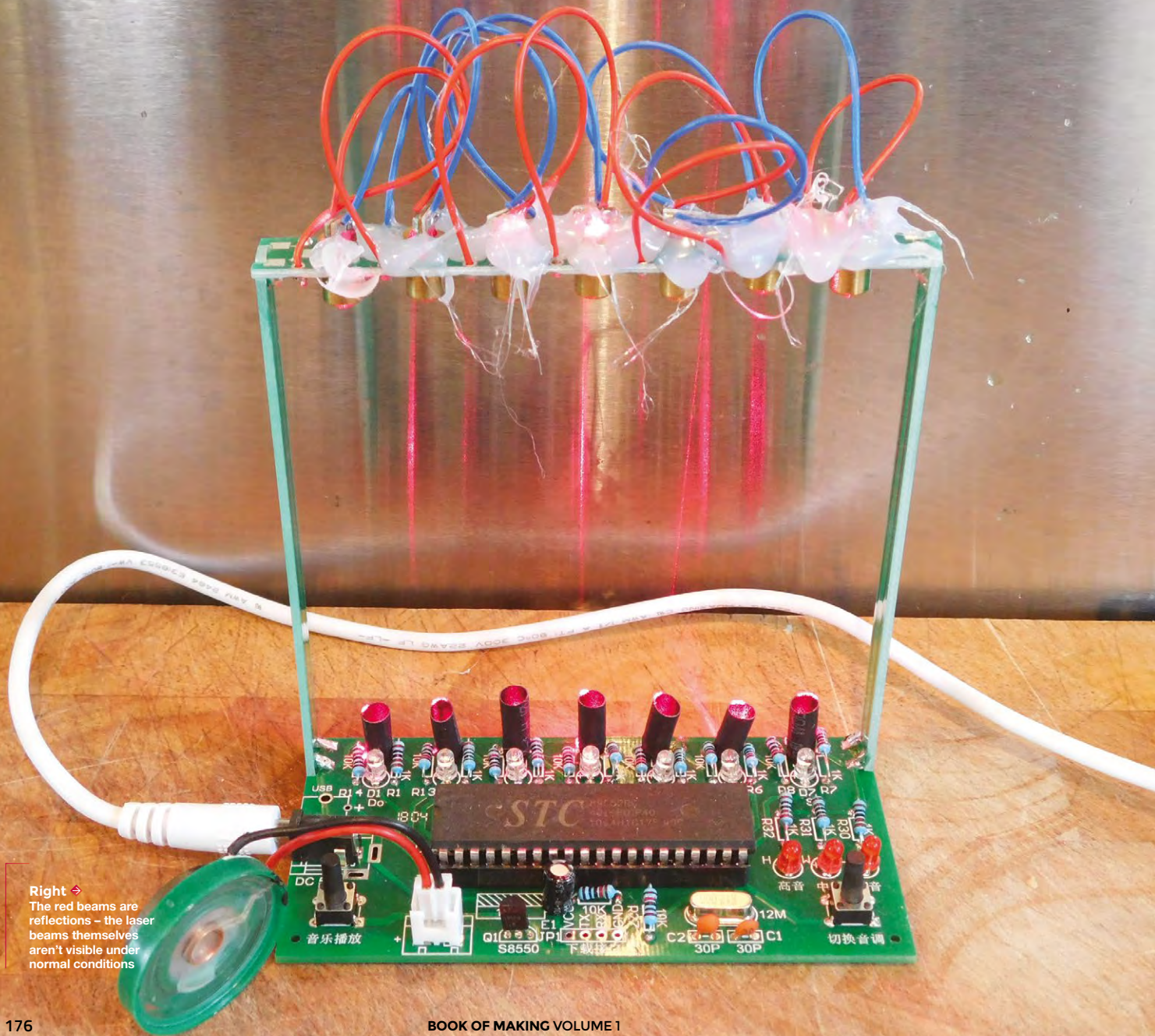

Right ⇨
The red beams are reflections - the laser beams themselves aren't visible under normal conditions

The basic principle of a laser harp is simple. It's a series of laser beams that, when broken, play a note. They vary from small hobby kits to huge performance instruments designed for stadium gigs.

We purchased a small harp kit for £8.59 (including postage) from e_goto Processors Store, on AliExpress. This is a 'framed' style of laser harp, where the laser beams shine onto sensors. Some other laser harps are 'frameless', where the lasers shine out to the distance. Frameless ones are more complex, but can work better at larger scales, particularly for performances.

The instructions came in Chinese, but they're not really needed. The PCB is marked with what component goes in which hole (everything's through-hole). The only slight issue was the orientation of the LEDs, as it wasn't clear which hole the plus sign in the silk screen referred to. Under close examination, we decided it was slightly closer to one hole than the other, and this proved correct.

The kit works by having a series of seven light-dependent resistors (LDRs) lined up on the bottom circuit board. These have a couple of centimetres of black plastic tubing slipped over them to block out most of the light. There are seven laser diodes, each lined up with an LDR, so that the beam fires straight down the tubing. When a laser beam is blocked, the light stops falling on the LDR and this triggers the harp to play a note.

POWER TRIP

When working with lasers, it's always sensible to consider the potential dangers. The laser harp came with 5mW laser diodes – brighter than we were expecting – and the dots they create can be dazzling, even when hitting a non-reflective surface. The UK Government advice on this laser power (Class 3R) is: "The laser beams from these products exceed the MPE (maximum permissible exposure) for accidental viewing and can potentially cause eye injuries, but practically, the risk of injury in most cases is relatively low for short and unintentional exposure."

This kit is right at the highest end of laser power that's considered an acceptable risk for general use, and you should consider this before purchasing.

The laser diodes have to be aligned by hand, and secured in place with hot glue. This isn't the best-looking system (and be careful not to burn your fingers as you do it), but it does work. The tubing around the LDRs means that they don't have to be perfectly accurate – as long as they're within the circle of tube, they should work. If you're concerned

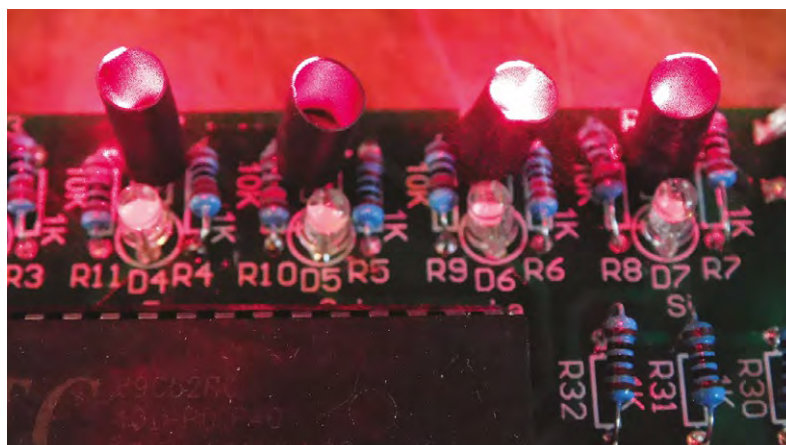

about aesthetics, you might want to enclose the top part of the harp in a more pleasing-looking material. Alternatively, you could easily create your own upper section – there's no need to use the PCB provided. The only wiring on this is to provide the laser diodes with power, so fitting this into wood or a 3D-printed structure should be fairly straightforward. However, if you do choose to modify the frame, you should consider whether this makes accidental exposure to the beams any more likely.

BRAINZ

The board is based on an STC89C52 microcontroller. It's programmable, so in theory you could update this to behave in any way you want. However, this isn't a chip with much of a hobbyist community around it, so we wouldn't recommend trying to reprogram it unless you've got experience with truculent microcontrollers. A far easier way of modifying this project (should you wish to) would be to take connections from the input pins on the STC to another board, such as an Arduino Uno (the STC is a 5V part, so you'll need appropriate protection if you use a 3V microcontroller instead).

The biggest disappointment with this kit is that it's only able to play one note at a time, so the classic harp sound of running your fingers across the strings is impossible to recreate unless you're willing to modify the software. However, if you're careful, it can be used to play a short tune. The harp creates a square wave which has a very computer-y bleep sound that's perhaps most commonly associated with chiptune-style music. There is a certain charm to this sound, but it's not very reminiscent of a harp. Close your eyes, wave your hand around in the harp, and the noises will take you back to the halcyon days of 1980s gaming.

This is a fun kit to put together, and makes an unusual curiosity. If you're willing to go further, it offers some possibilities for hacking into more visually pleasing forms. However, unless you're willing to tinker about with the microcontroller, you're not going to get anything capable of making interesting music. □

Above ♦ Plastic sleeves block out other light from the LDRs

DIRECT FROM SHENZHEN



THE Official
RASPBERRY PI
PROJECTS BOOK

VOLUME 4

**200 PAGES OF
 IDEAS & INSPIRATION**

THE OFFICIAL RASPBERRY PI PROJECTS BOOK VOLUME 4



DIY Games Console



Build a Robot



Set up a Spy Cam



Make a Magic Mirror

55 PROJECTS & GUIDES

200 pages of Ideas & Inspiration

FROM THE MAKERS OF *The MagPi* THE OFFICIAL RASPBERRY PI MAGAZINE

£12.99
200 pages of
Raspberry Pi

THE *Official*

RASPBERRY PI PROJECTS BOOK

VOLUME 4

Amazing hacking and making projects
from the makers of *MagPi* magazine

Inside:

- How to get started coding on Raspberry Pi
- The most inspirational community projects
 - Essential tutorials, guides, and ideas
 - Expert reviews and buying advice

Available
now

magpi.cc/store

plus all good newsagents and:

WHSmith **BARNES&NOBLE**

Available on the
App Store

GET IT ON
Google Play

BOOK OF MAKING

VOLUME 1

Hackspaces and makerspaces have exploded in popularity the world over, as more and more people want to make things and learn. Written by makers for makers, this 180-page book features a diverse range of projects to build. Grab some duct tape, fire up a microcontroller, ready a 3D printer, and hack the world around you!

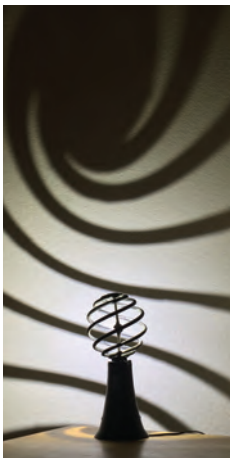
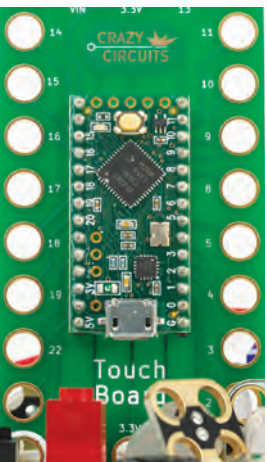

- Step into the wonderful world of making
- Be inspired by amazing community projects
- Make your own creations with step-by-step guides
- Perfect projects for an hour, afternoon, or weekend

Q4 2018

