



HackSpace

TECHNOLOGY IN YOUR HANDS

hsmag.cc

August 2019

Issue #21

Raspberry Pi 4

MAKER'S GUIDE

**DIY
POLLUTION
MONITORING**

Make sure you're breathing clean air

**ROTARY
TOOLS**

Cut, grind, sand, and polish your builds



August 2019
Issue #21 £6

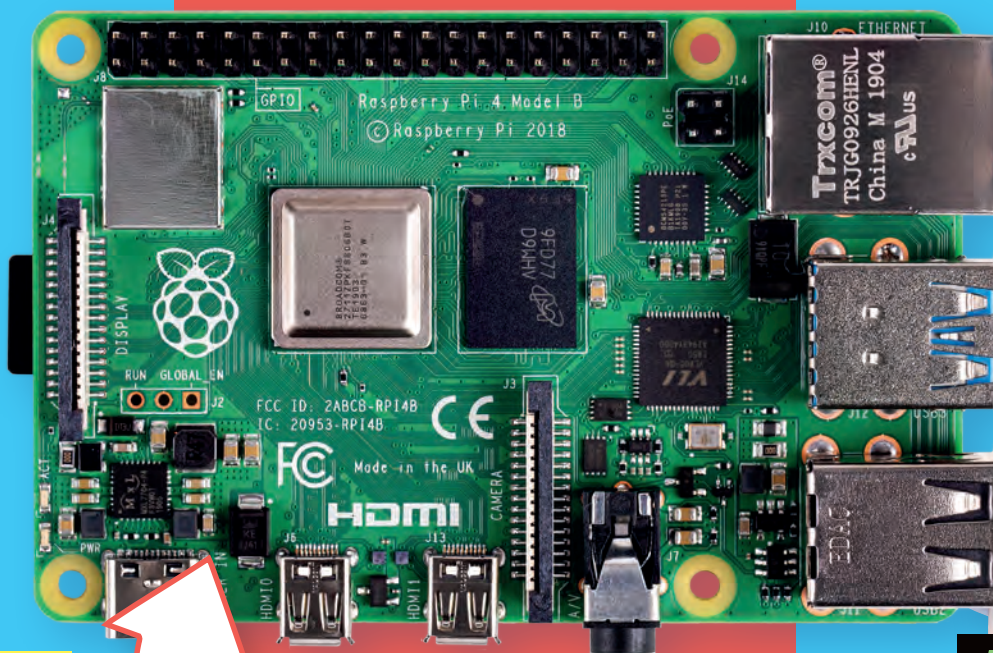

**KITCHEN
GLASS-MAKING**

Can you fuse glass in a microwave?

Add this powerful computer to your next project

ALLEN PAN

Thanos snapped his fingers and half our tools were gone



Welcome to HackSpace magazine

I can still remember the day the original Raspberry Pi came out. I didn't manage to order one on the day – I didn't wake up early enough and they were all gone, but I was able to order one a few weeks later. I still have that Raspberry Pi, and occasionally pop it into projects. I think the last time I used it was in 2018 (six years after I bought it), when I needed to control some lights over the network, and my other boards were being used elsewhere.

I just downloaded the latest version of the Raspbian OS, popped it into this old Raspberry Pi, and it booted up. This supporting of old hardware is still one of the things that impresses me most about the Raspberry Pi. There is no such thing as an unsupported Raspberry Pi. Think about that for a while. Every unit that has ever shipped will still run the latest software. No fiddling about finding drivers, or trying to work out what firmware you need, just download it, burn it to an SD card, and you can run your Raspberry Pi.

This month, a whole host of Raspberry Pi 4s sold out almost as soon as they were announced. I wonder what they'll be up to in six year's time.

BEN EVERARD

Editor ben.everard@raspberrypi.org

Got a comment, question, or thought about HackSpace magazine?

get in touch at hsmag.cc/hello

GET IN TOUCH

hackspace@raspberrypi.org

[hackspacemag](#)

[hackspacemag](#)

ONLINE

hsmag.cc



EDITORIAL

Editor

Ben Everard

ben.everard@raspberrypi.org

Features Editor

Andrew Gregory

andrew.gregory@raspberrypi.org

Sub Editors

David Higgs, Nicola King

DESIGN

Critical Media

criticalmedia.co.uk

Head of Design

Lee Allen

Designers

Harriet Knight, Sam Ribbits, Ty Logan

Photography

Fiacre Muller

CONTRIBUTORS

Lucy Rogers, Andrew Huang, Jo Hinchliffe, Krista Peryer, Mayank Sharma, Andy Clark, Brian Lough, Sophy Wong, Gareth Branwyn, Les Pounder, Marc de Vinck

PUBLISHING

Publishing Director

Russell Barnes

russell@raspberrypi.org

Advertising

Charlie Milligan

charlotte.milligan@raspberrypi.org

DISTRIBUTION

Seymour Distribution Ltd

2 East Poultry Ave,

London EC1A 9PT

+44 (0)207 429 4000

SUBSCRIPTIONS

Unit 6, The Enterprise Centre, Kelvin Lane, Manor Royal, Crawley, West Sussex, RH10 9PE

To subscribe

01293 312189

hsmag.cc/subscribe

Subscription queries

hackspace@subscriptionhelpline.co.uk



This magazine is printed on paper sourced from sustainable forests. The printer operates an environmental management system which has been assessed as conforming to ISO 14001.

HackSpace magazine is published by Raspberry Pi (Trading) Ltd., Maurice Wilkes Building, St. John's Innovation Park, Cowley Road, Cambridge, CB4 0DS. The publisher, editor, and contributors accept no responsibility in respect of any omissions or errors relating to goods, products or services referred to or advertised. Except where otherwise noted, content in this magazine is licensed under a Creative Commons Attribution-NonCommercial-ShareAlike 3.0 Unported (CC BY-NC-SA 3.0). ISSN: 2515-5148.

Contents

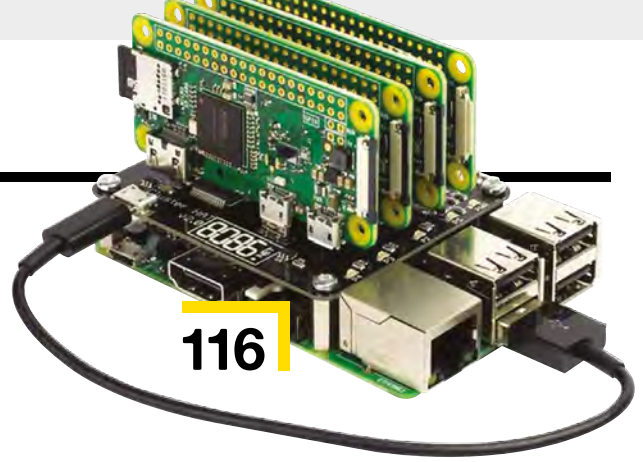

06

SPARK

- 06 Top Projects**
The Dulwich Picture Gallery of DIY projects
- 16 Objet 3d'art**
Precise plastic machinery
- 18 Meet the Maker: Jorvon Moss**
Folklore, magic, and the importance of failure
- 22 Columns**
Teamwork makes the dream work, apparently
- 24 Letters**
Fix your washing machine with a melted milk bottle
- 26 Kickstarting**
A handheld, classic console emulator
- 28 Hackspace Noisebridge**
Be excellent to yourself, and one another

33

LENS

- 34 Raspberry Pi 4**
Better, higher, faster, stronger computing
- 52 How I Made: Woodwork bench**
How to build out of wood when you can't cut straight
- 58 Walkin' & Rollin'**
Spreading happiness through custom wheelchairs
- 62 Interview: Allen Pan**
What it's like to be worthy of Thor's hammer
- 70 Wearable tools**
What you need to make wearable magic
- 78 Improviser's toolbox: Marbles**
Bouncy glass toys ready for your Dremel

Cover Feature

Raspberry Pi 4 MAKER'S GUIDE

Make this powerful machine the brains of your next build

34

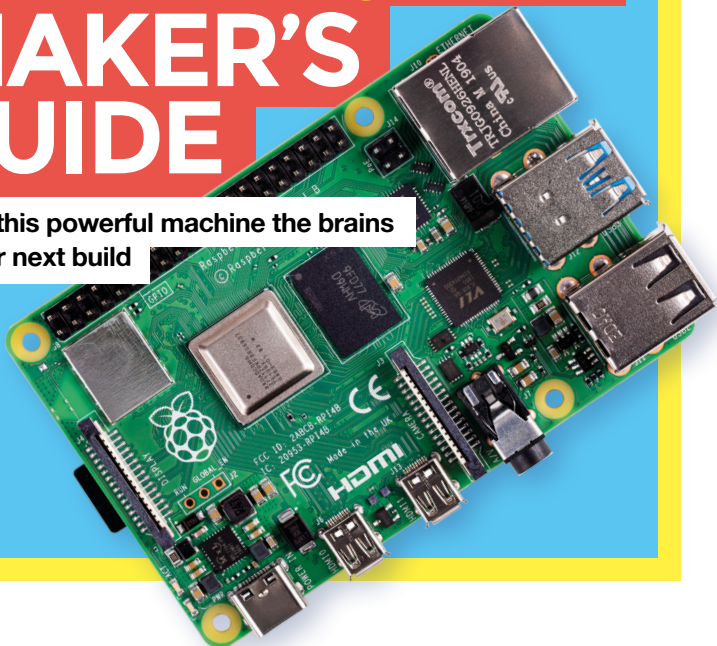

Tutorial

Tetris clock



100

Thank you, Alexey Pajitnov and Brian Lough



06



122

Direct from Shenzhen

Melt glass in a popty-ping

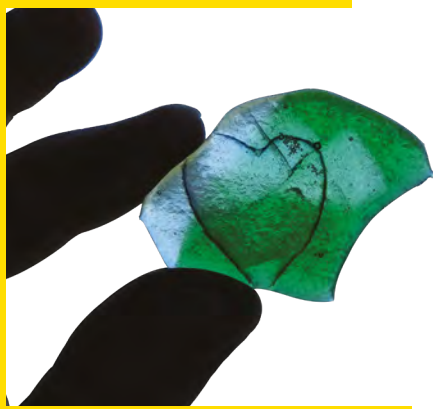

114

Fuse silicates into a decorative amorphous solid



88

Interview

Allen Pan



62

We let this man shoot us with a homemade 300V taser



18

83

FORGE

- 84 **SoM Power**
Changing voltages up and down
- 86 **SoM CircuitPython**
Save data to internal storage
- 88 **SoM Laser cutters at a glance**
What's going on in your desktop burny-box?
- 90 **Tutorial Toolmaking**
Bend, cut, and screw metal to your will
- 94 **Tutorial DIY pollution monitor**
Keep an eye on your local air quality
- 100 **Tutorial Tetris clock**
Tell the time with Tetris blocks
- 106 **Tutorial Workshop tips**
Get more out of your rotary tool
- 108 **Tutorial Fusion 360**
Design moving mechanisms on your computer

113

FIELD TEST

- 114 **Direct from Shenzhen Microwave kiln**
Melt glass in your kitchen
- 116 **Best of Breed**
Squeeze more fun juice from your Raspberry Pi
- 122 **Can I Hack It?**
Use the Force to hack a cheap Star Wars toy
- 124 **Review Arduino Every and 33 IoT**
The smallest Arduinos get an upgrade
- 126 **Review Korg Nutube OD-Kit**
The sounds of valve overdrive in a pedal kit form
- 128 **Review CircuitPython 4.1.0**
Adafruit's language for maker toys levels up
- 129 **Book Review The Art of Fermentation**
Enhance your life using bacteria



126

Some of the tools and techniques shown in HackSpace Magazine are dangerous unless used with skill, experience and appropriate personal protection equipment. While we attempt to guide the reader, ultimately you are responsible for your own safety and understanding the limits of yourself and your equipment. HackSpace Magazine is intended for an adult audience and some projects may be dangerous for children. Raspberry Pi (Trading) Ltd does not accept responsibility for any injuries, damage to equipment, or costs incurred from projects, tutorials or suggestions in HackSpace Magazine. Laws and regulations covering many of the topics in HackSpace Magazine are different between countries, and are always subject to change. You are responsible for understanding the requirements in your jurisdiction and ensuring that you comply with them. Some manufacturers place limits on the use of their hardware which some projects or suggestions in HackSpace Magazine may go beyond. It is your responsibility to understand the manufacturer's limits.

Cassandra

By Jen Allanson

Jenallanson.com

Cassandra is a fortune-telling machine, inspired by the Morgana arcade machine of the 1970s. A sensor detects a hand in the slot in the front of the machine, then a sound file plays a recording of a fortune-teller, while the video of a woman's face talking is projected onto a white polystyrene model head. The cabinet's plywood, and the coding is run off an old Mac mini.

Those are the bits that we can explain. What we can't tell you is how unsettling it is. Maker Jen Allanson told us that Cassandra is never left alone for the public to come across: "The first part of the fortunes come from the Tibetan book of the dead, about 80% of which is about, well, death. There always has to be someone about, in case someone gets a fortune that upsets them".

The recording that plays is randomised, but the magic of it is in watching how people react. "She might say 10 or 20 things to you, but you'll only remember the one or two things that are relevant to you. The technology is just a mirror for us to see ourselves in. People want to be seen". □



Right □

Cassandra gives out trinkets apparently at random – she gave our editor Ben a small metal bee... just as he was on his way to pick up some honey



HOPE

UNTOLD TRUTHS

Cassandra



DARK SECRETS

Please
PLACE YOUR HAND
IN THE SLOT







Chartreuse

By Anna Lynton & Alex Fiel

hsmag.cc/NmChjn

Chartreuse is an interactive face that follows you when you walk by. When she sees you, her eyes turn yellow, and she gets a happy expression in her eyes. As you walk away, her eyes change to blue, and she sadly turns away.

Chartreuse is powered by an Arduino Uno, two servos, and a stepper motor and a couple of addressable LEDs. She's constructed from a few pieces of 1/8" hardboard.

The creators, Anna Lynton and Alex Fiel, are both Technology, Arts, and Media Students at CU Boulder. □



Far left ♦ There's an ultrasonic distance sensor hidden in the base, watching you

Corporate companion

By Eight Bits and a Byte

8bitsandabyte.com



One of the downsides of being your own boss is that you don't get to snigger at inane nonsense dressed up as management speak. Laughing at endless meetings full of 'blue sky flagpoles' and 'leveraging synergies' have got us through many a dark time, so if you're missing a middle manager

in your life, why not make one yourself, like Eight Bits and a Byte (aka Dane and Nicole) have done.

All it took was an old briefcase, a Raspberry Pi 3 model B to control the thing, plus an MG995 servo motor to make the lid move, plus an Adafruit mini USB external speaker to dispense buzzwords, inspirational quotes, and conflicting and confusing advice. Accessorise with a tie and some googly eyes, and you've got a real-life corporate companion. ■



Above ■
"Try optimising your assets" says the corporate companion. Nice one!



Ramen bowl lamp

By Ramenkingandi

hsmag.cc/HKpZRQ

Although my online persona, Ramenkingandi, was inspired by a book with the same title, I do have a great fondness for the noodle-bricks that got me through college. So when I realized the standing lamp in my living room bore an uncanny resemblance to the oversized bowls featured at my favorite ramen restaurant, I knew I had to create this quirky lamp. As a hobbyist who dabbles in everything from cosplay to sculpting, I had almost everything I needed to complete this project on hand, so I began work as soon as inspiration struck.

First, the store-bought standing lamp was deconstructed, and the base and the bowl-shaped lampshade were repurposed to create the structure of the ramen bowl. The traditional light bulb was replaced with yellow LED strip lighting, both for their color and their long lifespan, and the remaining ramen ingredients – including pork slices, fish cake, and boiled eggs – were made from polymer clay, resin, and a small assortment of found objects. □



Right □
Someone seriously needs to do a giant Yorkshire pudding version of this



Zelda night lamp

By Michael Portera

hackster.io/mportatoes

I built a three-rupee version of this night light for my daughter, and decided to build a more colourful one using the rupees from two of my favourite Legend of Zelda games, both on the N64 (Ocarina of Time and Majora's Mask). The project uses programmable WS8218 LEDs for some really bright, great colours, along with an ATtiny85 for the brains and micro USB for power. The project is open-source and available on Instructables.

Michael is an infosec professional who enjoys maker culture, and dance parties with his toddler. ▣

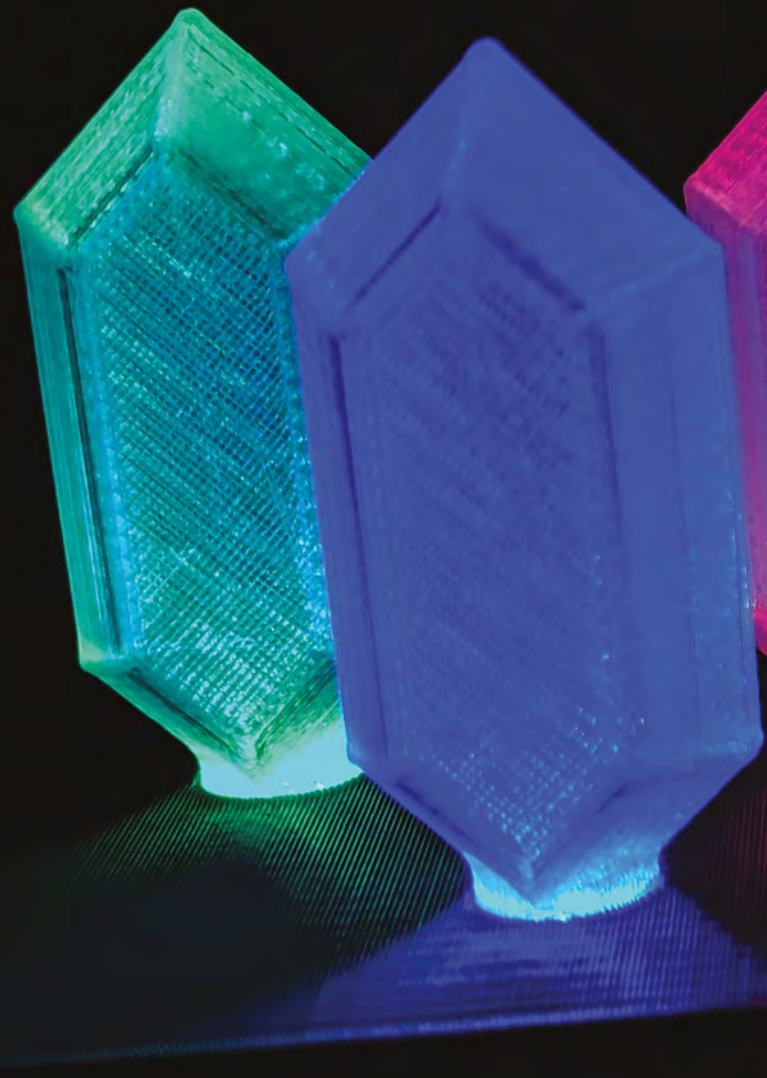

Right ▣
The gems are 3D printed out of clear PLA – their colour comes from programmable RGB LEDs



Objet 3d'art

3D-printed artwork to bring more beauty into your life

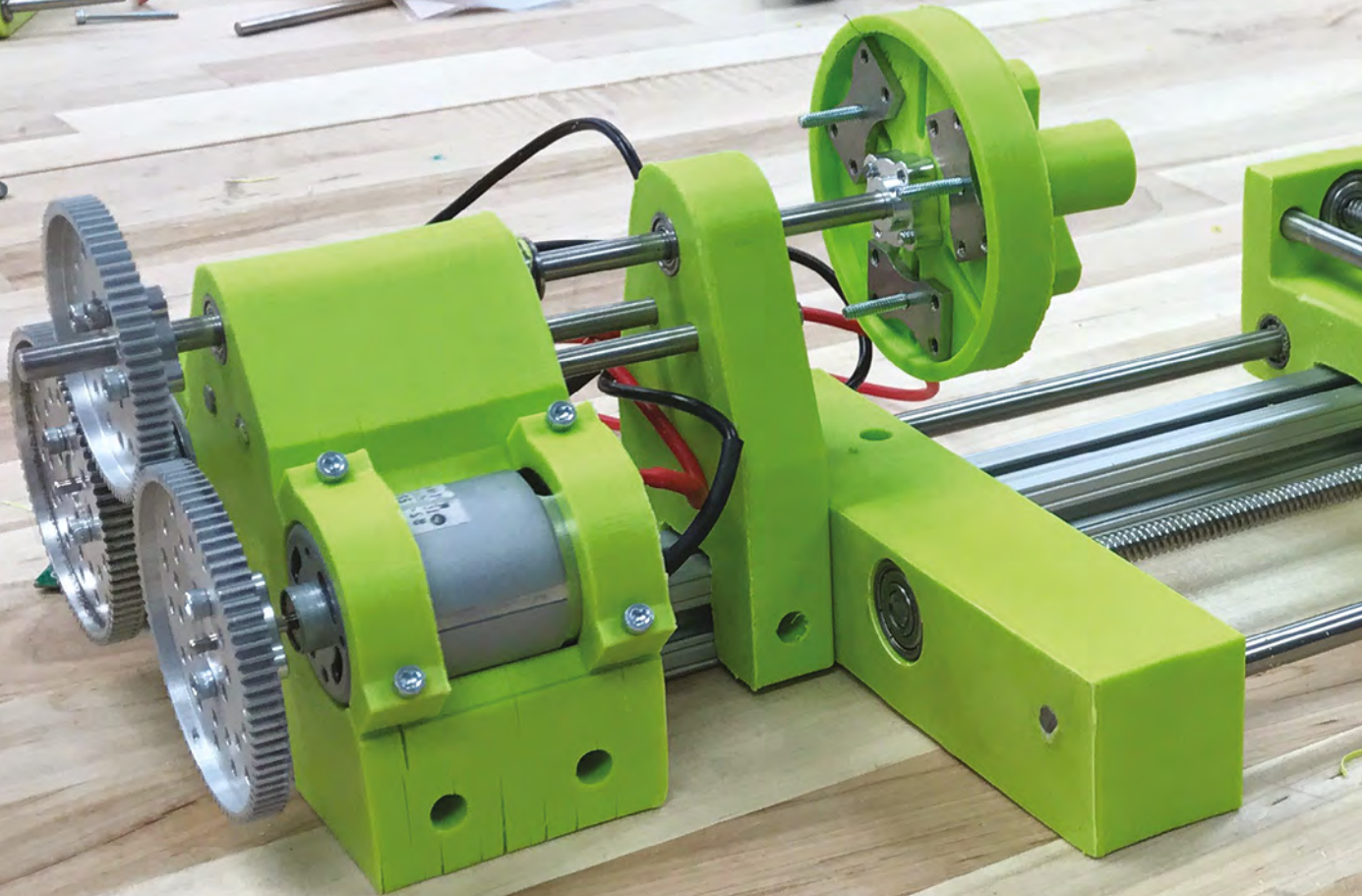



If you've ever spent ages fiddling with your printer's settings, only for it to produce blobs of useless plastic, you should be suitably impressed with this 3D-printed lathe, built by Harrison Freedman while he was still at high school. Impatient with the wait of sending robotics parts away to be machined, and with his school unwilling to let students loose on a full-size lathe, he did the sensible thing and made his own miniature one. It uses a 12V DC motor, some aluminium framing, and 6mm stainless steel shafting, and cost around \$200 to make. ▣

hsmag.cc/eFrljp

Meet The Maker: Jorvon Moss

The master of perfection

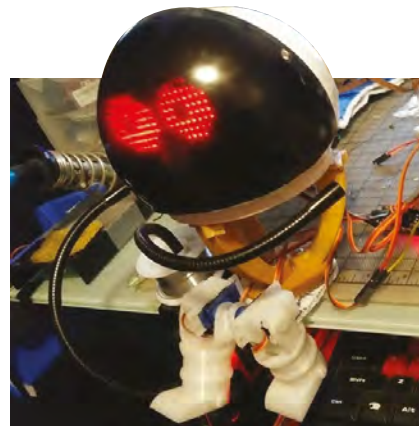

How does a steampunk-loving, comic book-drawing artist become a robot builder? It turns out, you just have to do it. And fail a lot while you're doing it...

"This is my robot spider, Anansi (shortened to Asi). His name is based on folklore. I went through different ideas, different gods, and I went for African folklore and a spider, because I thought it would be a simple design.

"There are three servos, one in the head, and two in the legs. It picks a number between zero and 180 degrees and, depending on the number, the servos will move to that angle. Real people are random, so it mimics life. Most people assume that he's looking at them; I've taken him on a field test back home in LA and sat on the bus with him, and I always get people convinced that he's looking at them. With kids, it's fun, but sometimes people get a little paranoid, so I've had to install an off switch. It's much easier than having to take the time to explain that it's all just random!

"This is actually V5, believe it or not. I've been working on him for about six or seven months now. V1 failed because of a wiring problem. V2 failed because the head was too heavy – I didn't hollow it out. V3 failed because the head only moved a few degrees in each direction, so people couldn't really tell that it was moving at all. When it came to V4, I added the dome, and just had the eyes move. That was the first success. This is V5 now. V6 will have more interaction with people.

"V4 was really easy – you print out the parts, and they're easily attachable. It uses two microcontrollers and three servos, so I feel like a lot of people could

easily make one quickly. Even the dome of his head is an old Christmas ornament that I had.

ADAPT AND MODIFY

"I'm hoping that if anyone likes what they see, instead of copying me, they'll produce their own spin on it. I'm hoping that in the future, I'll go to events and see people with bunnies on their shoulders, or beetles, or an octopus. Bring your own ideas.

"Coping with failure is hard. I try to learn from every last failure. The saying is that we're standing on the shoulders of giants; Anansi is the giant at this point. V1



With kids, it's fun, but sometimes people get a little paranoid, so I've had to install an off switch



worked really well; it had a working system, it looked back and forth. But the problem with V1 is that the wires connecting to the battery pack were attached very thinly, they didn't have enough hot glue to support the stress between them.

"So, when I took him out to a party, I was in the car, and he just stopped. He's not glowing, not reacting – what's going on? I had a second at my friend's place to stop and look at him, and I found that these wires had completely come undone. And of course, none of my friends had a soldering iron handy for me to fix it. So I learned about that and I learned about the design. →

Right ♦
That's the funny thing about people: we project a lot. People project their own visions on Asi; they're convinced it's a boy, or a girl



"I took a deep breath and decided to start from scratch. I started work on V2, which was so heavy that the servo could barely move the head. I took him out with me to a convention in LA called DesignCon. I walked through the door, said 'hi' to two people, and he broke about two minutes in. This time it wasn't a soldering problem; it was the gear that connected the head to the base that had broken. I learned from that though. I keep a journal all the time, and I make notes of things that I make, but I also pay attention to my failures. Failure is the best way to learn. It sucks at the time, but failing is the best thing that can happen.

"I've got to the stage now when I'm field-testing. I'll go to my makerspace in LA and throw the robot around, move him from left to right, throw it around. And when it fails, I'm happy about it, because I'm trying to make it fail – I need something to break, that way I know what I need to improve.

"Failure is just part of the game. Don't give up after a failure. The hardest thing about learning, and being

// When I'm field-testing I'll go to my makerspace in LA and throw the robot around – I'm trying to make it fail. I need it to break! **//**

self-taught, is knowing how to fail, which sounds like a bad TV show, but in my opinion, knowing how to fail is learning how to deal with the feeling of disappointment. A lot of people fail and they walk away from the project. You have to *not* do that.

"You have to learn that you're going to screw up a lot, and depending on how badly you screw up, each time you improve upon it, you learn a little bit more. You make the wires better, you print the gears better, and in the end, you can pretty much climb on top of all your failures to reach success. Man, that was corny!

SUCCESS THROUGH FAILURE

"I'm working on so many more projects now, thanks to knowing how to fail. I'm not going to pretend your feelings are invalid: your first failure is going to feel like crap.

"I went to the Academy of Art University in San Francisco, and majored in illustration. I drew comic books for a degree. I think midway through, I decided I didn't want to do it any more, mostly because I discovered more about the process of how it works between a pencil artist, an inker, and a writer. If you're the writer, you have full power, and everyone bends to your will. Because I would be the pencil artist, I



would have to go wherever the writer or the inker led me. A good example is that one of my teachers was working on a comic about the son of Superman. He inked this incredibly detailed scene of Superman's son sitting under a tree; he spent hours doing each individual leaf. He brought it to the class to show us – he was so proud of it. And the next day was the real lesson. He brought it back and told us that the pencil artist didn't like it. He ended up having to white out the entire tree and re-ink it – it turned into a blob with highlights on it. And that wrecked me. He'd spent so long inking that tree, only for someone to turn around and say 'I don't like it'.

"I still wanted to get my degree, so I stuck with it, but on the side, I was teaching myself programming; I got a lot of my friends' old laptops, and started fixing them. My parents thought this was kind of interesting – I would come back for vacation and they'd say, 'shouldn't you be drawing?' But instead, I'd be sitting in a corner figuring out some CAD software, or reading a book on electrical engineering.

"I think 'young me' would be impressed by what I can do at this moment. When I look at things, I can see how they work. I want to take them apart, and 3D-model them. I still remember a time when I had no idea how anything worked. It's an amazing superpower at this point.

"I got a Raspberry Pi, which is mostly used for programming. There's a character in the TV show *Young Justice*, Robin, and he had a gauntlet computer. I really wanted one, so I used thermal plastic and a whole bunch of rubber bands, and I strapped the Raspberry Pi to my wrist. I was able to get an LCD screen to work and a mini keyboard, and it started from there. It went from the Raspberry Pi, to gadgetry, to robotics. Robots are fun. But if you want to start with robotics, start with an Arduino or a Raspberry Pi." □

Right ♦
The animated lights inside a fixed head were inspired by the robot in Spider-man into the Spider-Verse



Get into a group and work together

Teamwork is about finding the right team



Lucy Rogers

[@DrLucyRogers](#)

Lucy is a maker, an engineer, and a problem-solver. She is adept at bringing ideas to life. She is one of the cheerleaders for the maker industry, and is Maker-in-Chief for the Guild of Makers: guildofmakers.org

This phrase used to make my heart sink. I hated working in groups. In school, university, and especially in industry, group work is important, but to me it meant not understanding the whole thing, lack of control (yes, I know) and the worst bit was having to take the load from those who were not as diligent as me. (I used to resent my 'responsibility trait' – the one that makes me feel physically ill and racked with guilt when I miss a deadline or break a promise – but that's another story).

It took over 30 years before I was in a team that was amazing. It was on a 'Camp Craft' course – we were learning how to use axes, make a base camp, and stay healthy in the wild.

I had not met any of my teammates before, but we worked together like a well-oiled machine. We'd take pride in doing the jobs efficiently and effectively – we were all good at listening, at following instructions, and at helping each other – there was also a lot of humour and gentle teasing. Whenever I noticed a job needed doing, such as filling the water containers or collecting firewood, I'd turn round and someone else was already doing it. Maybe I was the one who was slacking. We all brought something unique to the group – and for

the first time, I understood what was meant by 'greater than the sum of the parts.' Somehow we inspired each other to work harder and better, and yet it was easier and more fun.

At the end of the week's course, I felt a part of me was being torn out – so we have since met up for other adventures.

I have tried to analyse what was so extraordinary about the group. Was it luck? Chemistry? It wasn't just common interest.

Recently I was invited to join another team – I have known the members for a while, but I have never seen them at work. We had a 'trial run' last week. And, to my

At the end of the week's course, I felt a part of me was being torn out – so we have since met up for other adventures

delight, they were one of those special teams. They already work together really well – and there was again humour and gentle teasing. At times, the basics of communication were the bare minimum – 'hold this', 'do that', 'lift the other', but without personality or ego getting in the way. The job that needed doing was the most important thing. I could tell that everyone respected everyone else and, although each had their own particular skill, no one was precious about letting others have a go, or teaching them. And somehow it felt like a Lucy-shaped cog fitted perfectly. If it is luck that makes these kinds of teams special, I feel extremely lucky. □

The trade war continues

If lawyers mandate who can access open source, everyone suffers



Bunnie Huang

🐦 @bunniestudios

Andrew 'Bunnie' Huang is a hacker by night, entrepreneur by day, and writer by procrastination. He's a co-founder of Chibitronics, troublemaker-at-large for the MIT Media Lab, and a mentor for HAX in Shenzhen.

Stakes in the China-US trade war continue to ratchet up. At the time of writing, the US Bureau of Industry and Security (BIS) just placed Huawei, a \$100-billion dollar Chinese company, on the 'Entity List', a roster of actors that are denied access to US technologies that are controlled by the Export Administration Regulations (EAR). The move has cut off Huawei's access to a wide range of technologies, such as FPGAs, optical networking transceivers, and even basics like CPU cores from ARM and EDA tools for building chips. Fortunately, open-source technologies such as Linux continue to be available to Huawei, because EAR exempts open-source software from BIS's regulation.

However, the same day that the BIS ruling came out, Executive Order 13873 (EO13873) was issued by the US President. EO13873 declared a national emergency around the import and use of technology developed by foreign adversaries. The emergency broadly bans software, hardware, and services by organisations that could be influenced by adversaries. Significantly, EO13873 draws its power from a different US statute than the BIS's Entity List. Because of this, EO13873 could apply to open source.

If EO13873 were to be construed to include a ban on the use of open-source software, it would essentially force a

hard-fork of open-source projects along geopolitical boundaries: US-based projects could no longer incorporate patches or be influenced by foreign adversaries, under fear that this could expose critical US infrastructure to attack. This interpretation would also provide a potent tool for a closed-source incumbent to shut open-source alternatives out of the US market. For example, because Huawei is banned from using ARM CPU cores, it makes sense for the company to invest in RISC-V, which is an open-source alternative to ARM's closed-source CPU cores. However, if ARM could convince the US government to add China-based RISC-V providers to a list of foreign adversaries, then the import of this

open-source alternative back into the US would effectively be banned, thus securing ARM's continued monopoly on the US market.

During this trade war, the open-source community needs to carefully watch laws and mandates like EO13873. Attempts to limit open-source projects should be met with resistance, as this would give nations the power to effectively pick who gets to use open-source technologies. A core tenet of open source is non-discriminatory empowerment and sharing; knowledge should not be contained and controlled by a few countries. Open source benefits from the participation of good, engaged developers, regardless of country of origin. □

Open source benefits from the participation of good, engaged developers, regardless of country of origin

Letters

MAKER TIPS

"Knocking out the thin cuts from a woodworking joint is at least as satisfying as popping bubble wrap". YES! Cut a piece of timber several times across the grain to an even depth and you don't even need a chisel to clear the waste, just a few taps with a hammer. It's easily the best stress relief in town. That aside, I'd add my own tip to the collection: drilling pilot holes to stop screws splitting wood. It sounds weird because you're removing wood, but it actually makes the joint stronger too.

Paul

Ben says: Breaking stuff where it's meant to break should be a whole field of therapy.



IMPOSTERS

I admire your interview subject [Jen Schachter, issue 20] for talking so honestly about imposter syndrome. In a field with professional exams and accreditations you know where you are on the career ladder, but it takes guts to put yourself out there as a self-taught anything, with no authority to validate you or your work. I've been making things for a living for years now, but still worry that I'm charging too much, or that I'm going to be 'found out' because I don't have a degree. The most demanding client is yourself!

Sarah

Ben says: Naming no names, but the higher echelons of UK society are full of utter morons, utterly unburdened by self-doubt. A little introspection is healthy and good, and makes you a better person. If you don't lie about your experience and skills, how can you be 'found out'?

ATTENTION ALL MAKERS!
 If you have something you'd like to get off your chest (or even throw a word of praise in our direction) let us know at hsmag.cc/hello

3D-MODELLING

Thanks for the Fusion 360 guide to modelling moving parts – I've found Fusion 360 baffling for years, and still do, but it's good to have something to follow while I'm being baffled!

Connor

Ben says: It's in the nature of powerful software that it's always going to be hard to learn, but don't let that put you off: most people who use InDesign, or Blender, or Photoshop, or even Fusion 360, only use a few main commands, plus a tiny subset of features depending on their workflow. There's only one expert in your own workflow, and that's you.

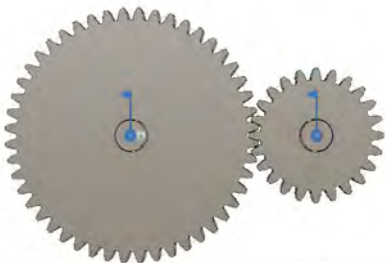

PLASTIC

I recently saw an article in an old HackSpace magazine about Perfect Plastics. I have been recycling 'plastic' milk bottles etc. for years after I saw a video on YouTube by Atomic Shrimp. He uses a flat, electric sandwich toaster. I use his method.

The only drawback is joining it together. The only permanent method I have found is to melt the HDPE and basically weld it together.

I use it mainly to repair or replace broken parts. I recently repaired the washing machine. The door release button broke. It was held in place by a thin piece of plastic. I tapped a thread on the shaft of the mechanism, and made a nut to fix it back in place.

Dave

Ben says: The good things about plastic is that it's so durable. The bad thing about plastic is... that it's so durable. The more we can keep out of the oceans and in our broken washing machines, the better.

ERRATA

Last month we splashed the words 'Top Maker Tips' on the cover and devoted 12 pages to little quirky tips that you won't find in any manuals, but will make you a better a maker. What we didn't do is credit the writer – Gareth Branwyn, who's also in this issue on page 106. Sorry, Gareth.

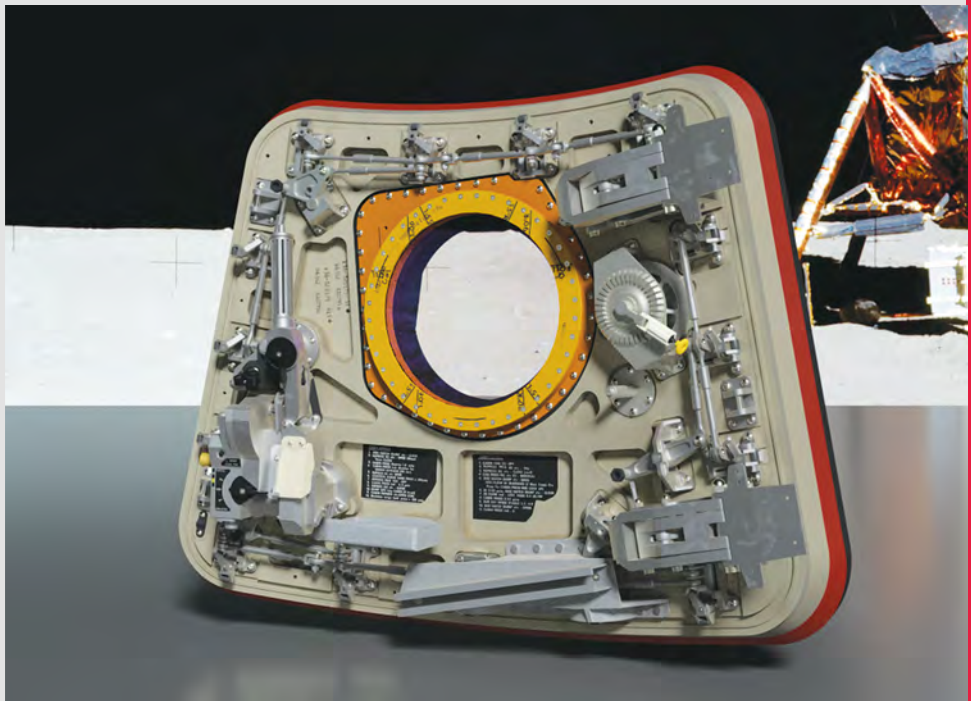

CROWDFUNDING NOW

Creoqode LYRA

Mobile gaming on Raspberry Pi

From £149 | [kickstarter.com](https://www.kickstarter.com) | Delivery: December 2019

Creoqode has combined a **Raspberry Pi 3 Compute Module Lite with an 800x500 5-inch display and a 3000mAh battery, to create a portable Raspberry Pi.** It comes either ready-to-play (£179), or as a DIY kit (£149), that requires a little hand assembly to build.

Once it's running, you can play games either using the in-built screen, or via an HDMI connector. As it's powered by a Raspberry Pi, you can also use it as a regular desktop, as well as a games console.

There are eight GPIO pins slightly awkwardly exposed on the back of the PCB that you can use to link up extra hardware.

Creoqode is a little evasive in their wording of what games you'll be able to play, and what consoles you'll be able to emulate on the LYRA (they say only that it'll emulate consoles from 'the classic era'). If it's in line with other emulation projects on Raspberry Pi 3, we'd expect that to mean that it can emulate 8- and 16-bit consoles without too many problems, and some slightly more powerful systems, if you're prepared to accept minor glitches.

Our biggest concern about this product is that it doesn't come with any games, and it's up to the end-user to source their own game ROMs. While there are bundles of ROMs available on various internet sites for download, it's not actually legal to use these. Creoqode's previous handheld consoles – the 2048 and the PYXA – have helped people learn to create their own games, so haven't had the same issues around intellectual property. There are some legally distributable games for these systems, such as the homebrew games at romhacking.net.

The hardware looks good solid – and Creoqode has a record of making solid handhelds. If the issues around games availability can be sorted, the LYRA looks like it could be a good portable Raspberry Pi. □



Below
As well as games, the LYRA can work as a normal computer



BUYER BEWARE

When backing a crowdfunding campaign, you are not purchasing a finished product, but supporting a project working on something new. There is a very real chance that the product will never ship and you'll lose your money. It's a great way to support projects you like and get some cheap hardware in the process, but if you use it purely as a chance to snag cheap stuff, you may find that you get burned.



//

The hardware looks good solid – and Creoqode has a record of making solid handhelds

//

Above 
The hardware looks like a great form factor for Raspberry Pi gaming

Space of the month: Noisebridge

Below ♦
Noisebridge is a 501(c)(3), which means everything is funded through donations



Noisebridge.net

Noisebridge is one of the longest established makerspaces in the US, having been founded in 2007. It's based in the Mission District of San Francisco, next to a grocer's shop. We went to visit, and were given the tour

by Mike, a regular there:

"Noisebridge is governed by one rule: 'Be excellent to one another'. What that means is, in every interaction with people within the space, try to be respectful, even if interactions aren't going the way that you want. If they're really going poorly, you can walk away. If they're really, really going poorly, you can ask them to leave. Likewise, if someone asks you to leave, you're expected to just leave, and deal with the situation later.

"There's an anti-harassment policy – don't harass people for any reason. If people are busy, if they've got their headphones on, staring down at their thing, leave them alone. Don't hit on people.

"In terms of how the space is run and who does what, everyone's a volunteer, so you have as much authority as everyone else. It's true for the majority of the things in the space. There's no cleaner here, so clean up your stuff after you. There's no one explicitly to buy things like toilet paper. If we're out, you should go buy some.

"That's the negative side of things. On the other hand, nobody being in charge means plenty of positive things. There's a computer over here attached to a modular synth. If you want to install some synth modules, clearly you can – you don't need to ask anybody for consensus to do that, because you're positively enhancing this area. However, if you wanted to do something like delete the operating system, put Windows on it or whatever, that's something that needs agreement. (It should be obvious not to do that, but it did happen one time.)

We use the term 'little-c consensus'. That's an example of little-c consensus. You don't need everyone's consensus; you just need the people in the area. →



Below ♦
This beautiful machine also plays Super Tux Kart, the free software racer 'inspired by' Mario Kart

Images
Trent Robbins



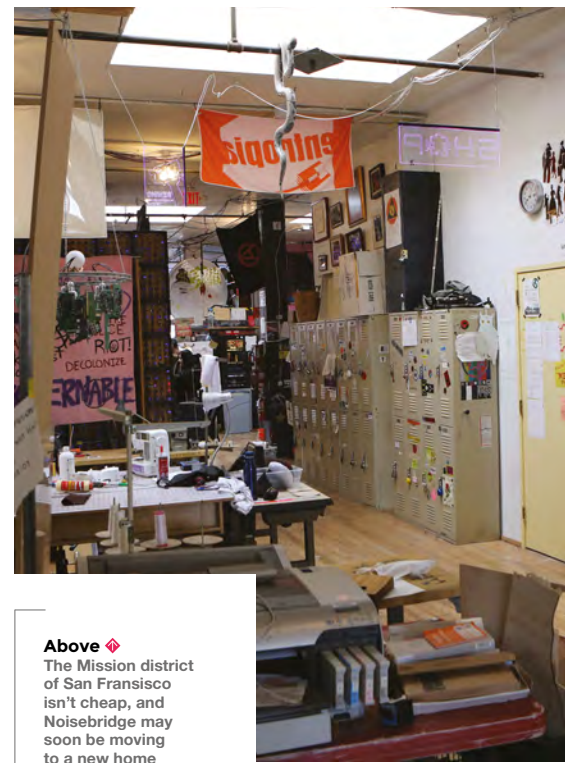

Above ♦ The Mission district of San Francisco isn't cheap, and Noisebridge may soon be moving to a new home

CONTACT US

We'd love you to get in touch to showcase your makerspace and the things you're making. Drop us a line on Twitter @HackSpaceMag, or email us at hackspace@raspberrypi.org with an outline of what makes your hackspace special, and we'll take it from there.



WHAT'S THERE?

"Noisebridge is divided into several areas. There's the library, with an OCR-enabled scanner. There's a lounge area, with an arcade cabinet for those all-important relaxation sessions.

"The walls of the main room are lined with project shelves – these hold people's personal projects. The rule is that if they've been there for more than 30 days, they'll be removed, but in practice, we have a cleaning day once or twice a year when things get moved.

"There's an electronics area, with oscilloscopes, bench power supplies, multimeters, solder, and a huge wall of components linked to a database. There's a database of little things like coin cell batteries, capacitors, resistors, that kind of thing. It's generally correct, and it shows where a thing will be if we have one. Nobody really updates it though. I really like electronics, but I'm just not going to do that.

"In the wood room, there's a CNC machine with a load of wood here to use. A powder coater, an oven to bake the powder-coated stuff. Personal projects are not supposed to be in the wood room – sometimes if someone's left a sticker on it saying 'do not hack', and someone's come along and cut it up, they'll complain. It doesn't matter – if a personal project gets left in the wood room, they're fair game. If you want to keep things safe, we've got lockers. You can claim a locker if there's no lock on it, and there's nothing in the locker. Both of these conditions have to be true. Otherwise, throw a lock on it, and it's yours (wire counts as a lock).

Above ♦
The woodshop has a router, band saw, drill press and many other sawdust-producing machines



“There’s also a music area – we’ve got Ableton installed on a computer there, and we hold regular music events.

“In terms of governance, there’s a concept of membership, but it’s not like other places’ memberships, where you pay money and that’s it: you have to apply for it and be accepted, so you have to know most of the people there, so they know you’re cool enough to be in – it’s a very social thing. But you don’t need membership to get access to the space – the only thing you need membership for is to participate in the governance of the space. That’s where the big-c consensus comes in. Everyone can pitch a thing for consensus, but when it comes down to forming a consensus (which is the state at which no one hates it – it’s not that everyone agrees, it’s more like no one is saying no), only the members can block a big-c decision. That would include something like moving premises.

“Most importantly, if you see something that’s broken, feel free to try to fix it. Noisebridge is a do-ocracy”. ◻



Below ◊
Noisebridge's sewing area

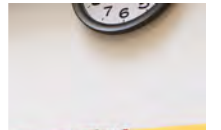

Above ◊
Everyone uses the laser cutter, and if you can, it’s good to bring some materials to cut with it – it helps keep it free for everyone





Build a Makerspace for Young People

Join our **free online training course on makerspace design** to get expert advice for setting up a makerspace in your school or community.

Sign up today: rpf.io/makerspace

LENS

HACK | MAKE | BUILD | CREATE

Uncover the technology that's powering the future

PG
52

HOW I MADE A WORKBENCH

Fill your workshop with
the glorious smell of pine



PG
58

WALKIN' & ROLLIN' COSTUMES

Making Halloween more fun,
one costume at a time



PG
62

INTERVIEW: ALLEN PAN

Saving a makerspace and
shooting people with tasers

PG
34

RASPBERRY PI 4 MODEL B

Discover the latest board
from Raspberry Pi



PG
78

MARBLES

Little orbs of glass for
you to make with

Raspberry Pi

The world's most popular mini computer gets a major upgrade

Since first launching in 2012, Raspberry Pis have given makers an invaluable tool. They've allowed us to put huge amounts of computing power in small spaces, program them easily, and let us control hardware. They're one of those magic tools that don't just let us build better projects, they let us build whole categories of projects that weren't accessible to most makers before.

What's even more impressive is that they've done this while still being easy to use. For many people, Raspberry Pis are the gateway into electronics. By exposing input and output pins, and making them easy to control from software, Raspberry Pi makes the journey from computer user to maker that much less intimidating.

Unless you've been hiding away in your workshop without venturing out into the world for the past month, you can't have escaped the news that there's a new Raspberry Pi in town – Model 4B. Let's take a look at what all this means, and whether you should be running out to replace your Raspberry Pis. →

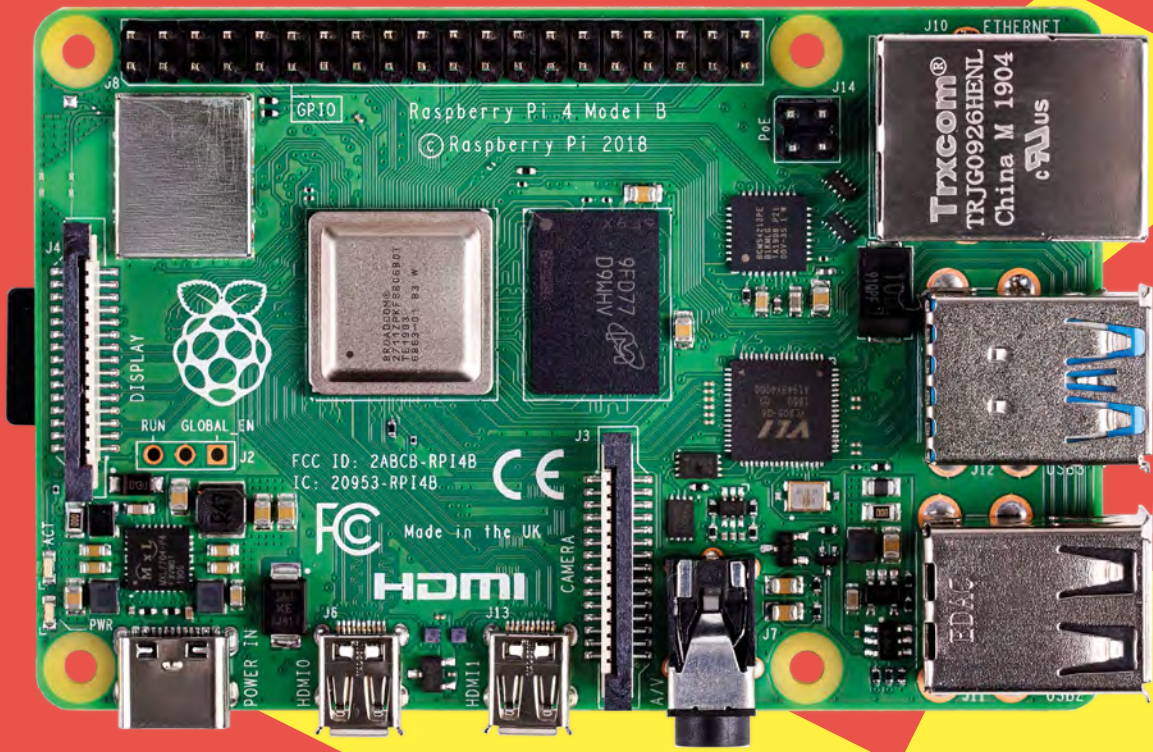

USB-C

Raspberry Pi 4 has a different power connector to previous boards. We asked Raspberry Pi (Trading) Ltd COO James Adams if this was here to stay:

“The answer’s yes for the foreseeable future. USB-C’s great. The pins are designed for more current – the old micro B connector was 2.5 amps, and we were pushing it a bit in terms of what it could do, but the USB-C is designed for 3 amps minimum, so we can do 3 amps at 5V.

“In the future, we could possibly use the PD power modes to turn the voltage up and get even more power into the board in some fashion. For power for Raspberry Pi, I think it’s the right answer. Never say never – you don’t know what’s going to come along next – but it seems like the right decision for now.”

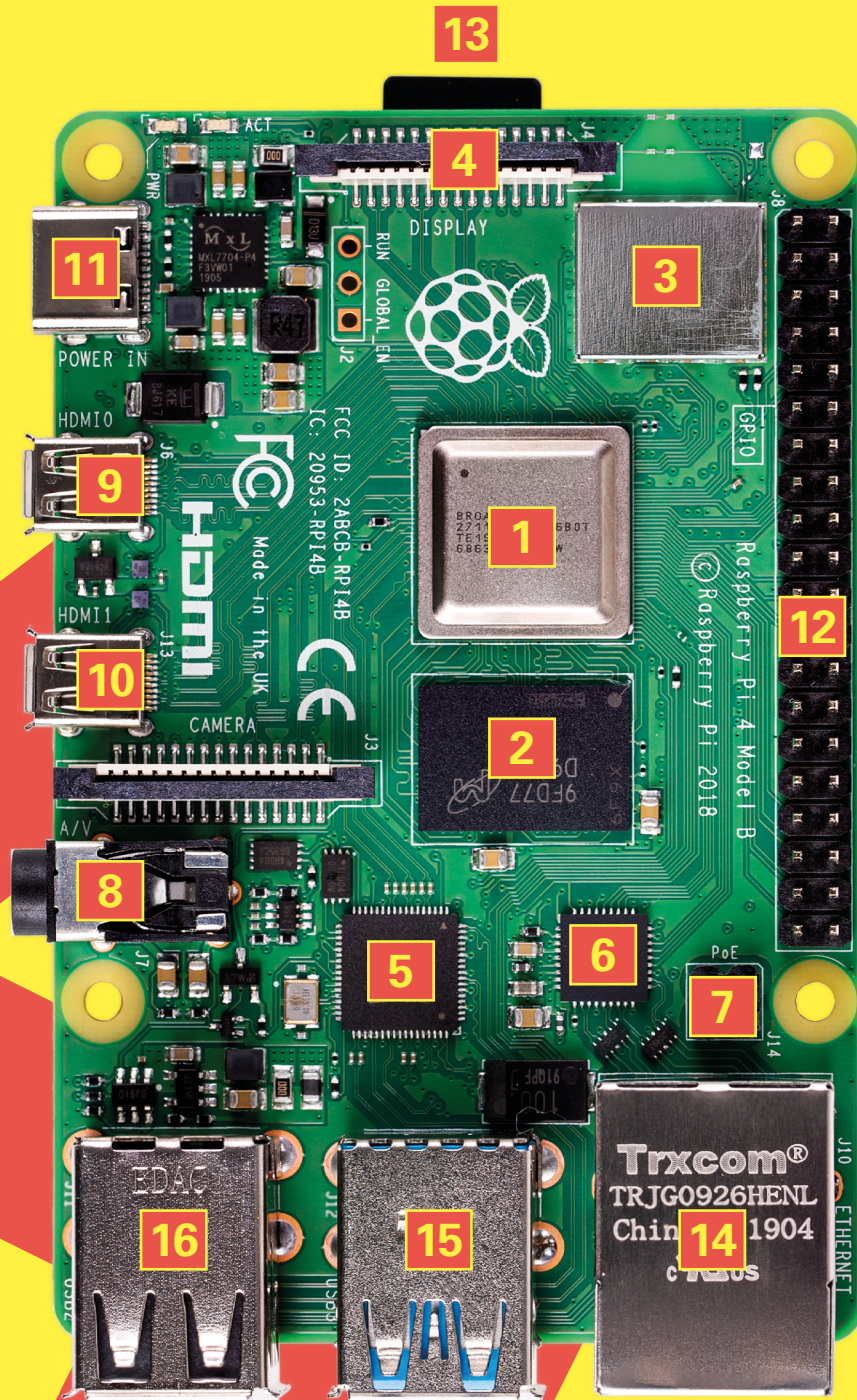

Raspberry Pi 4

in detail

What goes where on the new Raspberry Pi 4

- 1** A 1.5GHz quad-core ARM Cortex-A72 processor with Video Core VI graphics. The beating heart of the new Raspberry Pi model may not be much faster than the previous version in terms of clock cycles, but the more powerful cores mean that it can do more processing for each clock tick.
- 2** The LPDDR4 RAM is faster than in previous models and now comes in 1GB, 2GB, and 4GB variants.
- 3** WiFi and Bluetooth remain largely unchanged, but now supports Bluetooth 5.0.
- 4** The display connector for linking with the official touchscreen display.
- 5** The VLI USB chip connector gives USB 3.0 capabilities.
- 6** The BCM54213PE chip connects the Ethernet to a high-speed interface to the CPU.
- 7** The PoE header allows you to power your Raspberry Pi from compatible Ethernet networks, meaning you can use a single connector for power and networking.
- 8** The audio port also functions as composite video out.
- 9** The micro HDMI connector for connecting to a monitor (see box below).
- 10** There's a second micro HDMI connector to let you use dual screens.
- 11** USB-C provides 5V at up to 3A of current (see boxout).
- 12** The GPIO header retains the classic layout, but now also includes four UARTs, four SPIs, and four I²Cs.
- 13** The microSD card connector has twice the bandwidth of previous versions.
- 14** The Gigabit Ethernet connector has switched sides and is now next to the GPIO header.
- 15** The two USB 3.0 ports are identifiable by their blue tongues.
- 16** There are an additional two USB 2.0 ports that run slower than the 3.0 ports, but are still fine for most uses.

Micro HDMI

We asked Raspberry Pi 4 designer James Adams what went into making sure the micro HDMI connectors were robust enough for everyday use. Here's what he had to say:

"These things are much smaller than the standard HDMI, and therefore more fragile, so it's a thing that we were concerned about. We worked hard with two connector manufacturers [to mitigate this].

"If you look at the micro HDMI ports on the board, there are some flares that we added. That helps for two reasons. It helps the user insert the plug, and it helps with robotic tests. We have high volume, so we can work with suppliers and do great custom stuff. We did other things – we changed the

geometry of how the shell attaches to the PCB, and we also did a load of work to effectively vet the connectors.

"One of the out-the-gate connectors was substandard, and the manufacturer completely re-engineered it to get it up to our standards. We've taken samples through multi-cycle testing: so, put a connector on a machine and put the connector in and take it out 5000 times, and get a graph of the insertion and exit force over time, and look at the things and see if they survive. For sure, they're going to be a bit more fragile than the really big, chunky HDMLs, but we're confident they're fine. They should be a lot better than an off-the-shelf connector." →

Design process

How Raspberry Pi 4 came into existence

We chatted with James Adams, the Chief Operating Officer at Raspberry Pi (Trading) Ltd, and man behind the design of Raspberry Pi 4, about what went into the design.

HackSpace There are pretty big constraints on Raspberry Pi 4's design, both in terms of footprint and cost. Did you start with a list of features you wanted, and try to work out how to fit them in, or start with a clean board and keep pushing in features until you ran out of space or budget?

Below  James Adams, the man behind the design of Raspberry Pi 4

James Adams We knew in our minds what it should look like – we knew that it had to include all the backwards-compatible Raspberry Pi features, and we knew it had to include two display ports because the chip had been specifically engineered, and a second display was one of the things we requested of Broadcom. We knew we wanted to fix the things that people complain about like 1 Gigabit Ethernet, so we knew that had to go on its own PHY [physical layer]. From that perspective, it was fairly well decided. For various historical reasons, this Broadcom chip has a PCIe link on it, it doesn't have a USB 3 link on it. One of the questions was what to do with that. The desire was to get USB 3 on there, but we weren't

sure we'd be able to get it in the right cost structure. That doesn't necessarily mean that we wouldn't put it on there and change the board price, but we're very, very resistant to doing that. That was quite a bit of effort to go out and find out who can give us a PCIe to USB chip for the right price, without too much external circuitry to make it all work. Fortunately, we found the VL805 and they've been very helpful to us, so that all worked out quite nicely.

We've done a lot of work with connector suppliers, and found new connector suppliers, and worked really hard on the commercial side to make sure those come in at the price we need. There's a big chunk of engineering, a big chunk of commercial work and, you know, there's a bit of luck as well. Because sometimes the stuff doesn't exist, and there's also time in play. If we couldn't get to the price today, but we would be able to in six months, we could have delayed the launch.

There's a lot of factors in play. I guess that's the success of this engineering and commercial team – to be able to pull all that in. There's a huge multidimensional map of cost, time, and engineering that you try and pull into one product that works at the right price, with the right set of features. Looking back



on it, I think we've done a cracking job of it with Raspberry Pi 4.

HS What are you excited to see people do with the new capabilities of the Raspberry Pi 4?

JA This one – as we've shouted a lot about – is a PC. That's the thing: ever since I started at Raspberry Pi back in the day, I really wanted to get this to the sort of level where you can use it as a PC. Of course, this doesn't stop you using it for other cool things.

Other really interesting things for me are – with the extra CPU power and extra USB bandwidth – what are the extra things you could find? Edge computing is an interesting one, where you put a load of sensors on the edge of some sort of cloud service, and a Raspberry Pi can then only push the data back up that it needs to, so AI or image processing. This is a great little NAS machine as well. It's a great platform for that.

I think the PC is the most exciting for me. I can give it to my parents, or my kids, and they can actually use it as a machine to do lots of productive things with – it just ups the game. Of course, let's not forget the

We're interested to see what memory SKU people buy most of. That's the big unknown

GPIO. We now have four UARTs, four SPIs, extra I²Cs. For industrial guys, you've got a lot more options. I think we're going to see that. Although it's less shouted about in the media, I think it's all really quite a good upgrade from the previous boards.

HS Are there any things you're waiting to find out about how people use the board?

JA We're interested to see what memory SKU people buy most of. That's the big unknown for us. From a commercial side, we need to make sure that we've got the right numbers in stock of the 1GB, 2GB, and

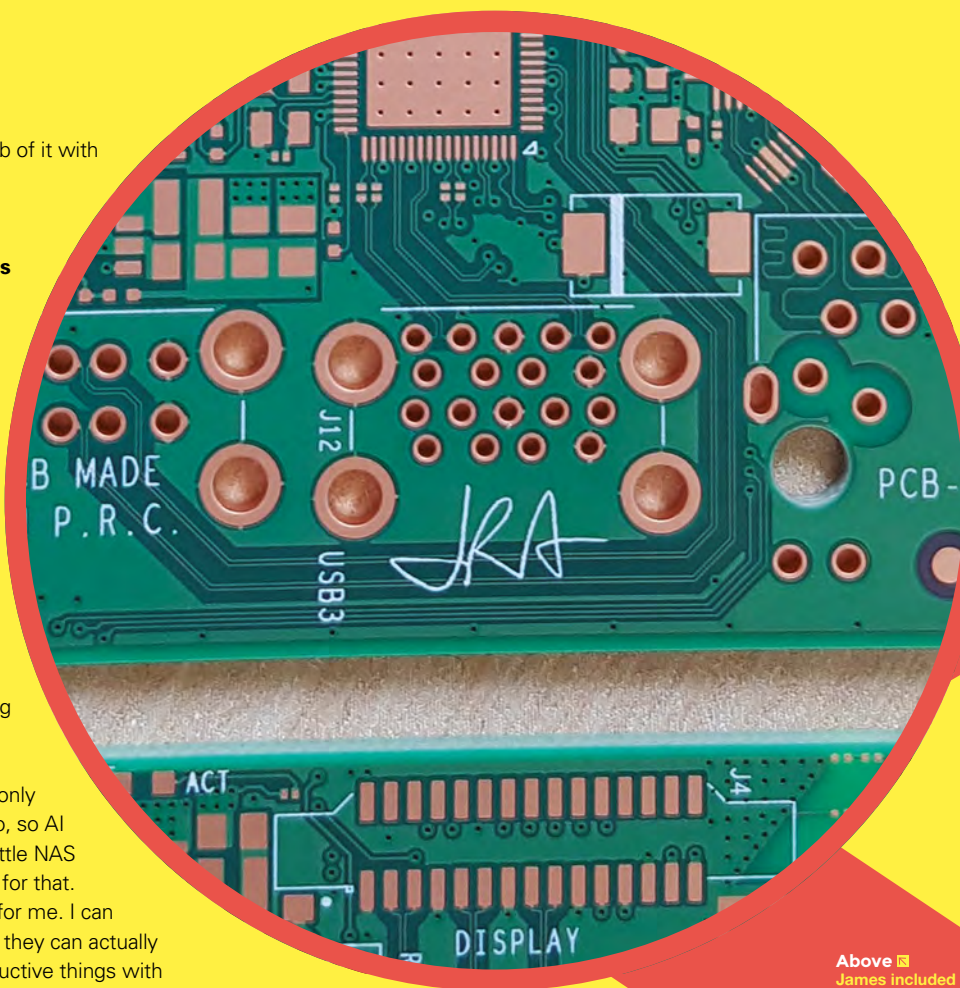

Above James included his signature under the USB 3.0 ports, but you'll have to remove the connector to take a look if you want to forge his cheques

4GB. Right now we don't know where that's going to land. There's a fun sort of commercial side to it where you have to leave the RAM buying to the last minute and our manufacturers – Sony – have to be able to switch so you don't end up with a massive stock of 1GB when everyone wants 4GB. It's an interesting commercial challenge that's new for Raspberry Pi because we've always just offered 1GB. It's going to be fun to see how that works out.

HS Are the different RAM chips completely drop-in replacements, so you literally just change the reel on your pick-and-place?

JA Largely, it's that. You put a different reel in. The test software has to put a different key into the board ID. The hard bit is making sure that when you're buying this volume of inventory each month, you're not stuck with a load of stock that you can't sell for the next six months. I know it's not engineering, but it's really interesting from a 'building products in volume' perspective. →

Raspberry Pi 4

the verdict

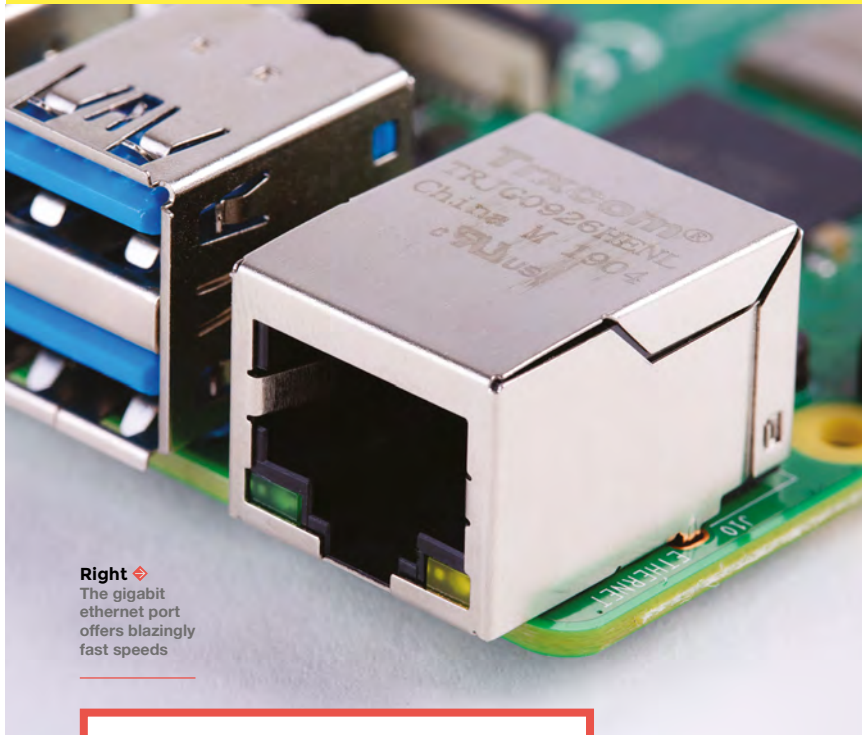

Right ♦
The gigabit ethernet port offers blazingly fast speeds



Left ♦
The microSD card port is faster than before

Which model is right for you?

1GB (\$35)

If you're embedding your Raspberry Pi in a robot, IoT device, or other things where it's going to be running one bit of not-very-intensive code, it's unlikely that you'll need more than 1GB of RAM.

2GB (\$45)

A happy medium for embedded Raspberry Pis that need to process larger amounts of data. This Raspberry Pi can also work as a desktop, provided you're not going to be running too many applications at once, or have more than a couple of browser tabs open.

4GB (\$55)

If you're planning on using the machine as a desktop, then this is the model for you.

Storage

New features of Raspberry Pi 4 make it a great choice for a network-attached storage (NAS) device. The extra Ethernet and USB speeds (for USB hard drives) mean you can share files on your home network (or beyond) far faster than was previously possible. You can build this on top of Raspbian if you'd like full control, or use a NAS distribution, e.g. Open Media Vault (openmediavault.org), which will be far faster to get up and running.

Extra speed

Is Raspberry Pi 4 not powerful enough for you? There's a bit of headroom for overclocking to make it run even faster. The clock speed can be pushed up to 1.75GHz if you're careful, but this makes your Raspberry Pi 4 run hotter, so you'll definitely need some form of cooling. This should give you an extra 10–15% performance, but it'll vary depending on the task.

Performance

The specs of Raspberry Pi 4 can be a little confusing. Compared to Raspberry Pi 3B+, the CPU doesn't get much of a speed boost, but it's using a different core architecture which allows it to do more processing in each clock cycle.

The board has had the sort of across-the-board changes that make more difference than any individual component. Memory's faster, the SD card port is faster, USB 3.0 allows you to use high-speed hard drives, and Gigabit Ethernet gives lightning-fast data transfer. These all play into each other. After all, there'd be little point in, say, Gigabit Ethernet if there wasn't a high-speed USB 3.0 connector to write data in or read data from. There's no point in a powerful processor if it's sat around waiting for memory.

It'll vary depending on what you use your Raspberry Pi for, but we find the Speedometer 2.0 browser benchmark gives a good overview of system speed as this stresses most of the computational parts of a computer. Raspberry Pi 4 performed this test at about twice the speed of a Raspberry Pi 3B+ (16.5 runs per minute, compared with 8.4).

Below  Double micro HDMI connectors let you use two screens



There are also performance factors that are really hard to benchmark, such as how 'snappy' the computer feels. The extra RAM options in the new Raspberry Pi means that switching applications and browser tabs is often far quicker, and the USB 3.0 allows you much faster access to external drives, which can also make the machine feel faster (depending on how the drive is set up). This feel is hard to analyse for formal benchmarks, but it has a huge impact on what it's like to actually use as a desktop computer.

As we go to press, the biggest unknown right now is the graphics speed. On paper, the VideoCore VI is quite a bit more powerful than the VideoCore IV in previous generations. If you run code designed for earlier generations, it'll run a bit faster, but there's more potential in there than this. The VideoCore VI is capable of running OpenGL ES 3 rather than OpenGL ES 2 (which was the limit for earlier generations). However, it requires software authors and maintainers to make changes in order to fully unlock this potential speed-up, and at the moment they're still working on it. In the coming weeks and months, expect to see some impressive new graphics on Raspberry Pi-related projects.

So, there's a whole lot to like about the new Raspberry Pi; however, as always, this comes at a cost. For makers, probably the two biggest concerns about Raspberry Pi 4 are power and heat. The new Raspberry Pi needs quite a bit more current to keep it running (around 1.5 A for a board under load plus mouse and keyboard, compared to about 1.3A for a Raspberry Pi 3B+, and as little as 0.3A for a Raspberry Pi

Overall, Raspberry Pi 4 is a fantastic upgrade to the previous versions

Zero). This power draw is still pretty low compared to most computers, and shouldn't be a problem if you're running on mains power, but if you're running off batteries or solar, then you may need to take this into account.

This extra power draw leads to the new model running a bit hotter than the previous ones. Thermal throttling kicks in at 85 degrees, and you may find that you hit this quite quickly if performing a CPU-intensive task – particularly if your Raspberry Pi is enclosed in something with limited airflow. A fan or heat sink will help things stay a little cooler, but add bulk and possibly extra power draw as well.

Overall, Raspberry Pi 4 is a fantastic upgrade to the previous versions. While it does make a good desktop machine, we're more interested in the more maker-y uses for it. Let's take a look at what this means to our embedded builds over the next few pages. →

Artificial Intelligence

Making your Raspberry Pi think



Artificial Intelligence, as a concept, has been around almost as long as computers have, but it's only in the last few years that software and hardware have come together to make it something that's useful.

There's no fully accepted definition of what AI is, but generally, it involves a computer inferring some information based on information it's seen in the past.

Whatever you want to do with it, artificial intelligence essentially comes down to running 'models' on data. These models are a precalculated brain that's trained with input data. The more computer power you have, the more complex models you can run, or the larger amount of data you can run them on.

Perhaps the most popular use for AI in making is in image processing – usually, image recognition. In

image processing, for example, having more processing power available means you can run models on larger images, and this gives you more accurate results.

FROM THEORY TO PRACTICE

Let's take a look at how to do simple machine vision on Raspberry Pi 4. We'll use the AI2GO SDK, as this provides prebuilt models that we can use with Python to work out what an image is showing.

To start with, you'll need to download the SDK from ai2go.xnor.ai, and unzip it. This file contains models and example code for a number of different architectures. However, before we can run the code, we need to set up our environment. Open a terminal, and navigate to `samples/rpi3/` (there's not yet a Raspberry Pi 4 version, but we get a speed-boost on the previous version with the newer hardware). Here, there's a script to install what we need, but we also need the `requirements.txt` file. Run the following in a terminal in the `rpi3` directory:

```
cp ./python/requirements.txt .
python3 install_dependencies_rpi.sh
```

This will ask you to reboot your machine (but you don't need to do this right away unless you want to use the Raspberry Pi camera code).

You can now `cd` to the `Python` directory to view the various scripts. Most of these pull the image directly from the Raspberry Pi Camera Module – and you can use these if you have one attached – but let's take a look at one that doesn't: `static_image_bounding_box.py`. This takes an image and draws a

Above ♦ Is this a person, a pet, or a vehicle? Don't worry, we've got an AI to figure it out for you!

rectangle around where it thinks a particular object is.

Before we can use a script, we have to load a model. The model in the SDK that works best with this script is person-pet-vehicle-detector, which identifies anything that's a person, pet, or vehicle. You can load this model with the following (run from the **Python** directory – you'll need to adjust the path if running it from elsewhere):

```
python3 -m pip install --user ../../lib/rpi3/facial-expression-classifier/xnornet*.whl
```

You can now run the code with:

```
python3 statis_image_bounding_box.py ../../test-images/horse.jpg horseout.png
```

This uses the **horse.jpg** image in the test images and creates a new image called **horseout.png** that has a rectangle around what it thinks is a person, pet, or vehicle.

What if you don't want to detect a person, pet, or vehicle, though? Let's now switch to a new model

The more computer power you have, the more complex models you can run

that detects faces. We can only have one model installed at a time, so first, we have to uninstall the current model with:

```
python3 -m pip uninstall xnornet
```

Now you can download a new model. Go to the AI2GO website and click Model Selector > Raspberry Pi 3 > Photography and video > Detection > Face Detector, then hit Continue and go to Download. Unzip the downloaded file and open a new terminal and **cd** into the unzipped file. You can install the new model with:

```
python3 -m pip install --user xnornet*.whl
```

You can now run the script as you did before on the horse test image, but this time you should find that there's no rectangle as there's not a human face in the image. However, if you run it on an image of an angry face with the following code, you should find the face rectangled.



Above ♦ There's a wide range of models available for AI2GO that are already optimised for Raspberry Pi hardware

```
python3 statis_image_bounding_box.py ../../test-images/angry.jpg faceout.png
```

Of course, we don't have to limit ourselves to this example code. You can incorporate the AI2GO script in your own code. If you take a look at the script, you'll see that the key part of the detection and drawing is done with:

```
boxes = model.evaluate(xnornet.Input.rgb_image(image.size, image.tobytes()))
drawer = PIL.ImageDraw.Draw(image)
image_width, image_height = image.size
for box in boxes:
    top_left = (int(box.rectangle.x * image_width),
               int(box.rectangle.y * image_height))
    bottom_right = (
        int((box.rectangle.x + box.rectangle.width) * image_width),
        int((box.rectangle.y + box.rectangle.height) * image_height))
```

The first line of this runs the model against the image, and this returns a list of 'boxes' that surround sections of the images. In the example script, it uses the Python image library to draw rectangles around these boxes, but you could use this data as input for a robot (such as to use it to turn towards a face), or a security camera (to get it to upload the picture to cloud storage), or any of a myriad of other uses.

This is the basics of AI on Raspberry Pi 4. It's up to you to blend this into your project. →

USB power

AI might not be an area where you'd expect the newer connectivity to come into its own, but there's now a market for USB AI peripherals that can provide a significant speed boost, and the faster data transfer of USB 3.0 can make a big difference to the performance of these. The Coral Dev Stick, for example, lets you run TensorFlow Lite models far faster than is possible on raw Raspberry Pi hardware, and runs around four times faster on Raspberry Pi 4 than on Raspberry Pi 3.

Games Galore!

Relax with a little brain candy

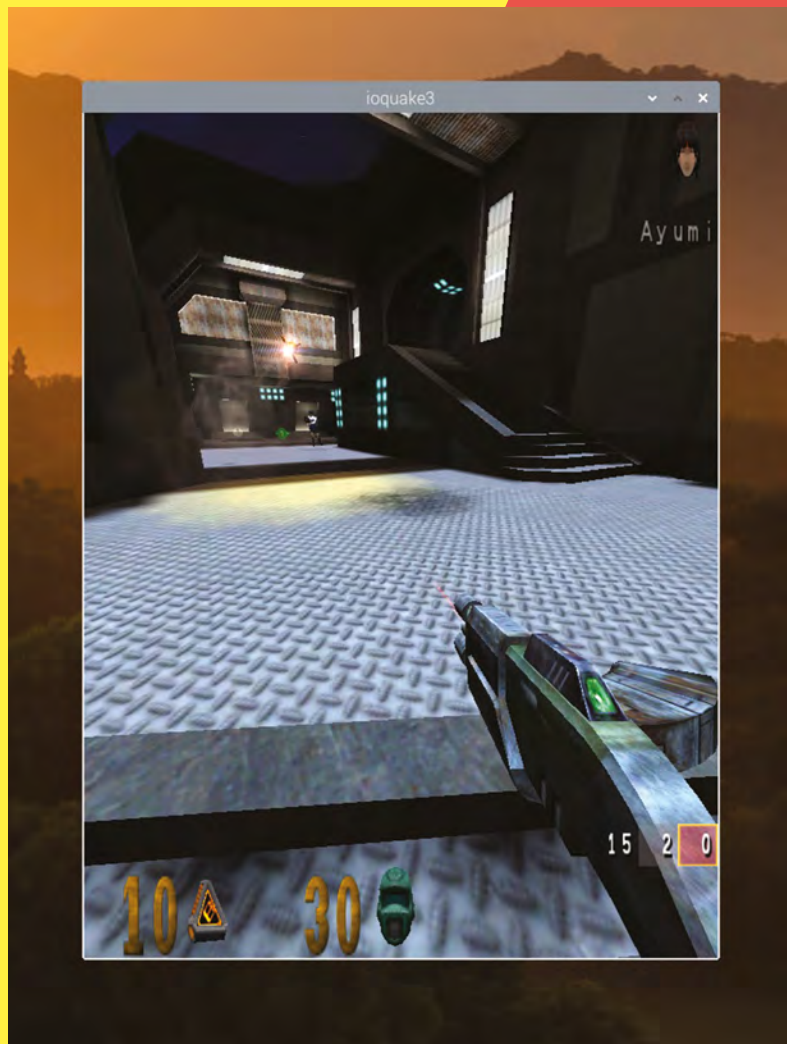

For gamers, Raspberry Pi 4 gets a triple bonus over the older models. There's a faster CPU, newer GPU, and the option of more RAM.

The newer GPU probably has the most direct impact, as it opens up the possibility of OpenGL ES 3 for the first time. Previous versions of Raspberry Pi could only use OpenGL ES 2. However, it'll probably be a little while before we see games set up to use this new hardware to full effect.

One of the magical things about modern computing is that you don't have to limit yourself to games written specifically for the hardware you're using. Through the magic of emulation, you can virtually create different machines, whether that's through DOSBox (which allows you to play DOS games) or a console emulator. These require a little tweaking to get maximum performance from the hardware, and many people play these via a specific retro gaming distro, such as RetroPie (retropie.org.uk). At the time of writing, they hadn't released a version for Raspberry Pi 4, though one is likely to land shortly and may be available by the time you read this. Bear in mind that if you do go down this route, the legal status of games emulation depends on how you get the games. Take a look at the box on the next page for more information.

PICK OF THE BUNCH

Of course, it's not all about emulation. There are some great games that run natively on Raspberry Pi. Here are a few of our favourites:

Left  Fast-paced, first-person shooter action in OpenArena

OpenArena

This is built off the open-source code for the game engine used in Quake III Arena. It's a first-person shooter where you run around an arena trying to kill other players (either simulated or connected via the network). It's fast-paced and great fun.

0 A.D.

A real-time strategy game where you have to build an army and battle with other societies. You can play as one of 13 civilisations from antiquity, including Athenians, Britons, and Carthaginians.

Minecraft

The classic block-building game is a favourite of Raspberry Pi users because not only can you build, but you can control the game from software, including taking inputs from the GPIO pins on your



There are some great games that run natively on Raspberry Pi

Raspberry Pi. This allows you to link the real and virtual world in unusual ways.

The newer Raspberry Pi will bring better graphics settings to games like OpenArena, and for games like Minecraft (which you can interact with from

Emulation ROMS

Emulators require ROMs to run. These ROMs are basically the digital version of cartridges that were used in physical consoles. There are some sources of these online, but they're illegal – pirating software is still pirating software, even if it's old software.

You can pull data directly from the cartridges using something like a Retrode. Unfortunately, the legal status of these is unclear and may vary between jurisdictions – copyright law is complex, and this form of running has never been tested in court.

Fortunately, you can enjoy retro games running on the (emulated) hardware of your youth without getting bogged down in legal uncertainties. There's a community of games makers building open-source (or otherwise distributable) games for this hardware. A great place to start looking for homebrew games is romhacking.net.

other programs) more spare CPU cycles for your extra code.

Of course, we're makers, not gamers, so it's not just about which games you play, but how you play them. We love the ingenuity of the maker community in this area, and here are a few of our favourite options for maker games projects...

Arcade machines

For many people of a certain generation, their first introduction to computer gaming was on arcade machines. For this author, it was Golden Axe at the local swimming pool, where we went for school swimming lessons. If we rushed out of the changing rooms, we had time for a few games while we waited for our classmates to dry off. You can relive the memories of your youth by building your very own games console based on a Raspberry Pi. If you don't have space for a full machine, you can make a tabletop version.

Retro builds

Computers don't live forever. At some point, even the most loved console comes to the end of its life, but you don't need to unceremoniously dump it in the bin. You can use it as a case for your Raspberry Pi, and keep the aesthetics alive on your new gaming rig.

Kerbal Space controllers

You can control the iconic game Kerbal Space Program over either a serial link or a network. This lets you build control centres for your in-game spacecraft, and these controllers can be as complex, or authentic, as you like. There are some examples of what can be done at hsmag.cc/aFYQoy.

However you play games, the new Raspberry Pi is a fantastic upgrade. →

Above ♦
Link the real world with the virtual in Minecraft on Raspberry Pi

Controlling electronics

Link the real and virtual worlds

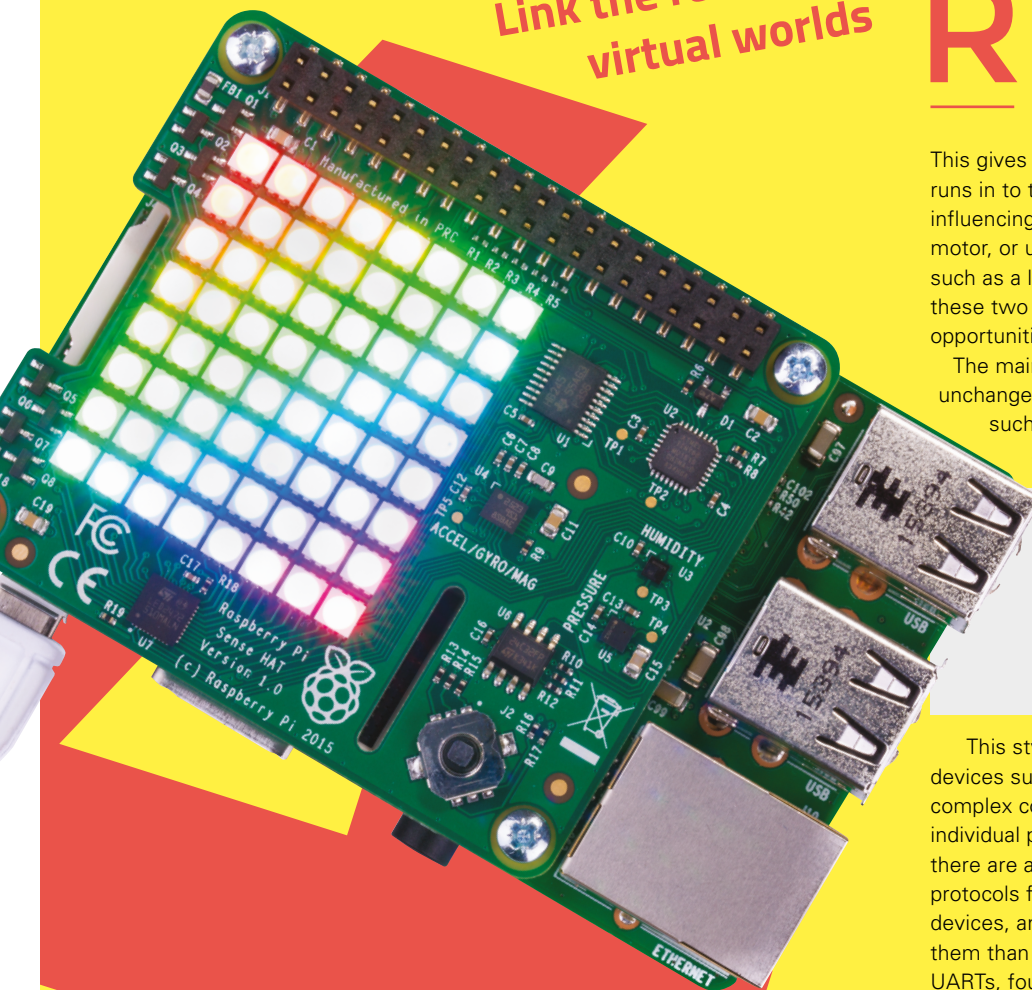

Above  Most people expand their Raspberry Pis using HATs, and these will continue to work as before

Raspberry Pi popularised the idea that general-purpose computers can have programmable ‘pins’ (known as general-purpose inputs and outputs, or GPIOs) that you can switch on or off, or read values from, in software.

This gives you a link from the virtual world your code runs in to the real physical world. Whether you’re influencing the world through an actuator such as a motor, or understanding the world through a sensor such as a light-dependent resistor (LDR), when these two worlds combine you get some great opportunities for making.

The main GPIO header remains physically unchanged, and you can still access it with Python, such as with the following code that will turn an LED on and off on pin 17:

```
from gpiozero import LED
from time import sleep
led = LED(17)
while True:
    led.on()
    sleep(1)
    led.off()
    sleep(1)
```

This style of GPIO control is great for simple devices such as LEDs, but when you need a more complex connection than just on/off, switching individual pins can be difficult. To make this easier, there are a series of standard communication protocols for sending data between low-level devices, and Raspberry Pi has a whole lot more of them than previous iterations. There’s now four UARTs, four SPI buses, and four I²C buses – let’s take a look at what this means.

These buses are for communication between different devices. You can think of them a bit like very simple USB connections in that they define a

Right 
The basic pinouts remain the same, but there's extra functionality hidden in the pins of the new Raspberry Pi 4

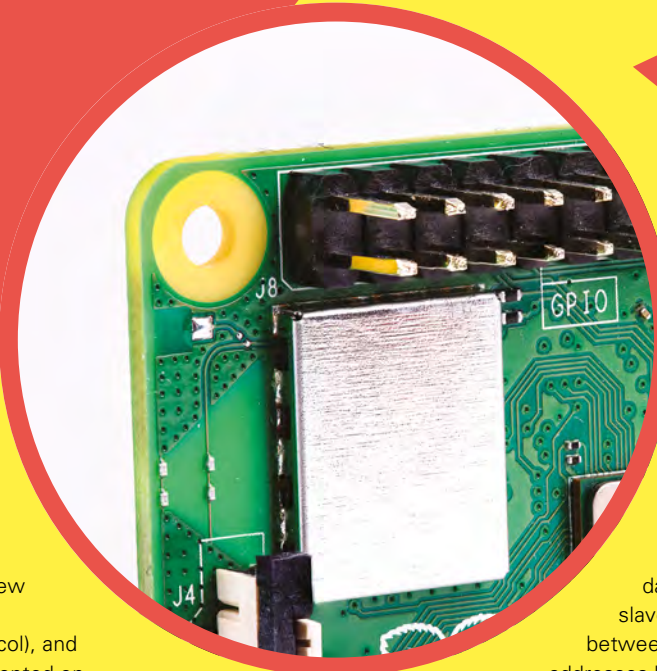

standard for connection and communication. However, they're far less complex than USB. Communication takes place over a few wires (two to four depending on protocol), and they can be implemented on much simpler hardware. Often chips can be wired into UART, SPI, and I²C buses directly.

Universal Asynchronous Receiver/Transmitter (UART)

This is the old-fashioned serial protocol that you may remember from older PCs (though these serial connections had a number of extra connections that aren't commonly used any more). This takes place over two wires, with the Transmit (tx) of one device being connected to the Receive (rx) of the other. For two devices to communicate, they have to be at the same communication speed (baud).

Serial Peripheral Interface (SPI)

The main communication takes place over two wires – Master In Slave Out (MISO) and Master Out Slave In (MOSI). As you'll notice from the names, in SPI there's a 'master' device that controls communication, and a 'slave' device that only works when connected to a master. The SPI ports on Raspberry Pi operate as masters, so can be connected to 'slave' peripherals. Unlike UART and I²C, SPI is a synchronous protocol, so it also needs a clock connection (usually denoted SCLK). Multiple slaves can be connected to a single SPI bus, and each one has a 'slave select' (sometimes called chip select) connection that can be turned on or off to activate that slave. Only one slave should be active at any one time.

Inter-integrated circuit (I²C)

There are only two connections in I²C – Serial Clock (SCL) and Serial Data (SDA). All the devices on the

I²C bus connect to the same SDA and SCL wires, and the master can distinguish between many slaves because each slave has an address. These addresses are often fixed into the slave and listed on the data sheet. Some slaves allow you to pick between a few possible addresses by connecting various pins to ground. In theory,

you can connect up to 1008 devices to a single I²C, but in practice, you can only connect a few of each device.

These three protocols are all binary level, in that you get a raw stream of bits out. In order to be able to use a device connected by UART, SPI, or I²C, you need to know what format it expects data in, and in what format it will send data out.

The advantages of having extra ports depend a little on the protocol. UART is device-to-device, so

The SPI ports on Raspberry Pi operate as masters, so can be connected to 'slave' peripherals

having more UARTs makes it far easier to connect more than one device to your Raspberry Pi. SPI can connect many devices, but as only one device is active at any one time, you lose speed – which is one of the big advantages of SPI – for each device added. With I²C, it means you can connect many devices with the same address, which makes it easier if you want to add multiples of the same device to your Raspberry Pi.

These extra ports mean it's easier to connect extra hardware to your Raspberry Pi 4 than earlier models. Even if you don't plan on getting down to that level of detail, it frees up hardware designers to use these in their HATs and other add-ons. →

Desktop machines

A PC in your pocket

Perhaps the biggest area where people will see an improvement is using the new Raspberry Pi as a desktop computer. The extra speed in all areas, and the extra display, make it a low-cost, low-power option for general computing. There's easily enough power for general office use and web browsing.

Raspberry Pi alone is obviously just a bare PCB, so you're going to need some more bits to transform it into a working desktop computer. There are a few options here. There's the official Raspberry Pi Desktop kit, which bundles a 4GB Raspberry Pi 4 with a keyboard, mouse, and case, as well as a power supply, SD card, and all the cables you'll need. You also get the *Beginner's Guide* book to show you how to use your new Raspberry Pi. All this comes in at £115. Just add a monitor and you'll have your desktop ready to go.

Of course, as makers, we're always looking for ways to customise our builds, and our desktop is no exception. All the peripherals on Raspberry Pi are things we can personalise. Take a look on any maker hardware website and you'll see a selection of screens that can be embedded into cases or stands to take the place of usual monitors. Similarly, there's a small cottage industry of designs for cases for the different form factors of Raspberry Pi.

You don't even have to stick with premade keyboards. These are made from keys wired in a grid with a microcontroller to scan for button presses and



Above ♦ Portable screens can let you use your GUI on the go, without having to be locked down in a laptop form factor

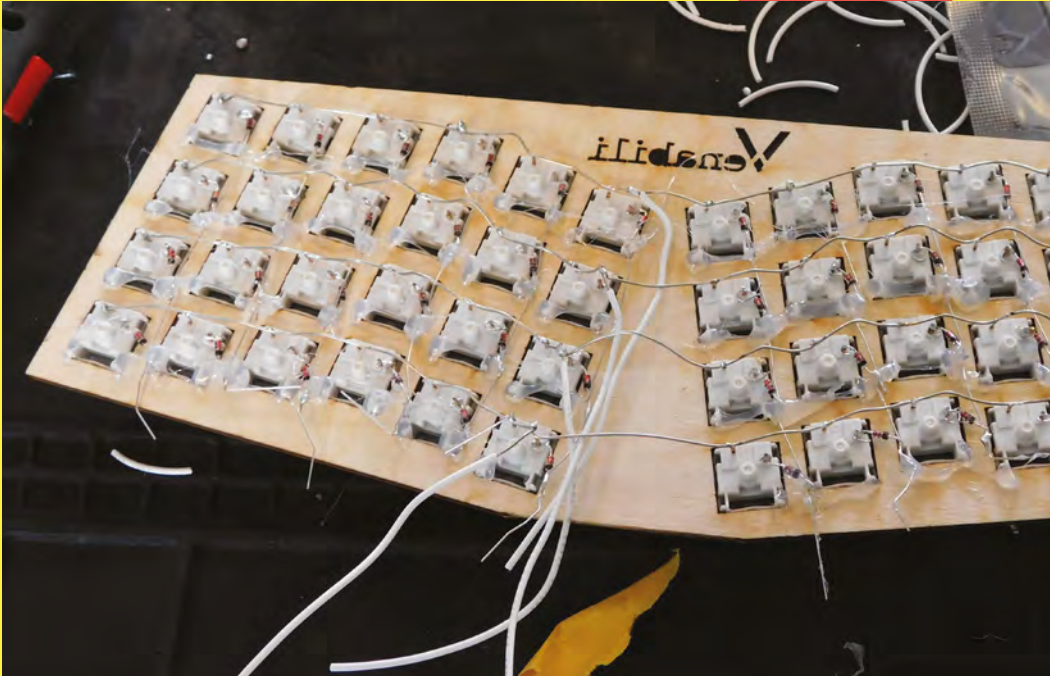

convert this into key codes that are sent over USB. There are various off-the-shelf firmwares for microcontrollers that handle this. We'll be looking at the Venabili keyboard in a future issue of HackSpace magazine that uses an STM32 microcontroller.

When we talk about desktops, we don't just mean the old tower-shaped beige boxes, but any way of working with the desktop interface. The low-power Raspberry Pi is a great choice for portable computing. Although Raspberry Pi 4 draws more power than earlier versions, by computing standards it's still low power. Look at the various Raspberry Pi

If you need even more power than Raspberry Pi 4, you could consider a cluster

laptop cases on Thingiverse for ideas of what's possible with a Raspberry Pi and a 3D printer (some will need adapting to work with Raspberry Pi 4).

If you need even more power than Raspberry Pi 4, you could consider a cluster. Using the Gigabit Ethernet connector, multiple Raspberry Pi 4s can work together on tasks even faster than previous versions. It's tricky to get multiple Raspberry Pis working together on tasks, but it's a great way of

learning to use the technologies that power many of the world's data centres.

Raspberry Pi 4 makes a great desktop machine, and its size makes it easy to fit into a range of cases. Whether you're just looking to add a little aesthetic flair to your case, or embark on a full laptop build, this is a great board to start building on. □

USB boot

There's a hidden speed increase that's waiting to spring out in a software update – USB booting. At the moment, you need an SD card to boot your Raspberry Pi, and by default, the operating system lives on this SD card. While the interface to this SD card is faster than on previous models, it's not as fast as the USB 3.0 connection. Speed will depend on the SD card you have, but typical performance is 35MBps read speed, and 45MBps write. If you connect an external drive to Raspberry Pi 4's USB 3.0 ports, you can expect performance in excess of 300MBps for both read and write, if the external drive can handle that (and a modern SSD should).

With the current firmware, it's possible to transfer your operating system to a USB drive, but the engineering team at Raspberry Pi are working on firmware to allow true USB booting. Once we have this, we expect a noticeable bump in file-system performance which should mean that software loads more quickly, and 'swapping' of applications (where your OS runs low on memory and sends the memory of applications that are running, but not currently being used, to disk) should be less noticeable. Overall, this should make Raspberry Pi feel like a much nicer desktop computer.

Above □
The Venabili keyboard that this author is currently building for a future issue of HackSpace magazine

SUBSCRIBE TODAY FROM ONLY £5



SAVE UP TO 35%

Subscribe today and get:

- ▶ **FREE delivery**
Get it fast and for FREE
- ▶ **Exclusive offers**
Great gifts, offers, and discounts
- ▶ **Great savings**
Save up to 35% compared to stores

➔ **Subscribe online:** hsmag.cc/subscribe

SUBSCRIBE TODAY

Subscribe for 12 months

Rolling monthly subscription

£55 (UK)

£90 (USA)

▶ **Low monthly cost** (from £5)

£80 (EU)

£95 (Rest of World)

▶ **Cancel at any time**

Free Raspberry Pi 3A+ with 12-month upfront subscription only
(no Raspberry Pi 3A+ with rolling monthly subscription)

▶ **Free delivery to your door**

▶ **Available worldwide**

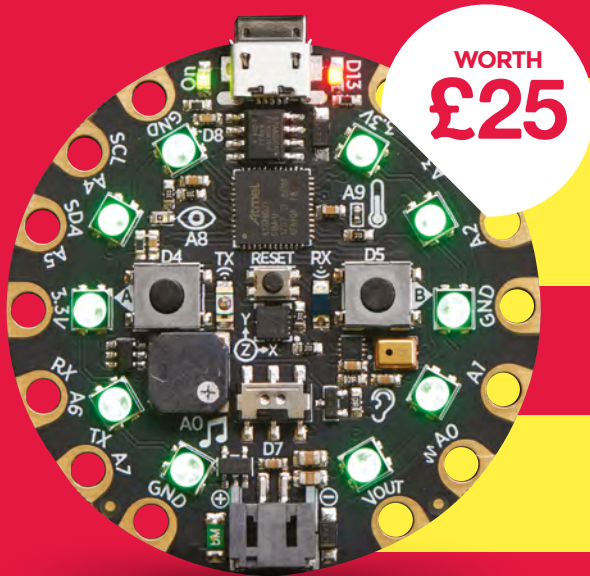

FREE!

Adafruit Circuit Playground Express

With your 12-month print subscription

This is a limited offer. Offer subject to change or withdrawal at any time.

SUBSCRIBE on app stores

From **£2.29**



👉 Buy now: hsmag.cc/subscribe



How I Made A WOODWORKING BENCH

A surprisingly sturdy workbench,
made with minimal tools

By Andrew Gregory

Making things out of wood is brilliant fun. It's tactile, it puts you in touch with your ancestors, and it smells good. It's also very

easy to get wrong, if you're trying to saw a piece of work propped between two chairs, or hanging off the end of a wall. I needed a better solution. On a sunny weekend, I built a woodworking bench.

The dimensions very nearly chose themselves. The biggest length of timber I can fit in my car is 2.4 metres, so that was what I bought. Half that is 120cm, which became the length of the bench.

I decided on 90cm for the height of the bench, which is near enough half my height and so, ergonomically, is a sensible height to be working at. 240cm lengths of wood, with two 90cm bits cut off, gave me offcuts of 60cm each, which became the width of the bench. It all seemed too neat to be true, and it was, but the principle of making the most out of the materials to hand is a sound one.



Above ♦ The finished bench looks a little rustic, but works as well as one costing far more

MATERIALS

I used C16 graded spruce 45×95mm (1¾ inch by 3¾ inch), which is extremely common and is available everywhere. I could have gone with pine, but that would cost more money for no benefit.

The timber I chose was cheap, but there are massive benefits to a softwood such as spruce, compared with a hardwood such as oak or beech. For one, it's literally softer, so it'll dent rather than damage whatever you're working on. Benefit two is that, as it's soft, it grips the workpiece better than hardwood, which has a tendency to be slippery. Benefit three is that, as it's soft, it's easier and quicker to cut than hardwood. If I'd chosen oak, I'd still be working on it now.

And, most importantly for a minimum viable bench, the timber I used is about a fifth the price of oak.

Other specifications: it has to have chunky, solid legs that will transfer the force of a mallet when I'm chiselling down on a workpiece. 45mm by 95mm is probably good enough for this, but I thought I'd go for overkill and double them up using two pieces

Below ♦
Some of the legs needed a little trim, bringing the height down to 89cm + the thickness of the MDF



of timber stuck together somehow. Twice as thick must mean twice as good, right?

Apart from the dimensions, the legs, and the overall tightness of construction, the next most important part of any woodworking bench is the top. In the European tradition of fine woodworking, this should be a heavy laminated slab of hardwood, but I don't have the space, the skills, or the time to source, cut, plane, and glue a worktop. You may have seen videos online of people laminating sections of 2x4 timber together to make a worktop on the cheap, but that's still far more demanding than my budget allows. Those people also usually have access to machinery such as planers and joiners, which can take uneven slabs of wood and give them a consistent thickness and width. The most advanced tool I have is a drill, so construction methods have to be a little rustic.

The structural opposite of a laminated block of hardwood as a benchtop is a bit of MDF, and, as there was a water-damaged 60 cm x 120 cm x 18 mm chunk of it on offer in B&Q for £5, that's what I went with. Before you throw up your hands in horror, the discovery of MDF for such an appealing price led me to a design decision that I'd been mulling over: the bench would have to be modular. When the top inevitably gets damaged beyond the point of no repair, I should be able to just take it off and put a new one on. Next time it might be plywood, or planks, or something else that's easy to replace.

I still felt a bit uneasy about this, but then I discovered the Nicholson bench. In contrast to the French model of making a bomb-proof top that lasts a thousand lifetimes, English craftsmen would build their benches to be partly disposable. The Nicholson bench uses an apron at the front, which holds bench dogs along with the vice at the front, and also adds to the stiffness of the structure when planing or sawing along the length of the bench. And instead of working on a solid, vertically laminated benchtop, they'd use planks, and plane them level every so often, replacing them when they got too thin. If it's good enough

for the chaps who built HMS Victory, it's good enough for me.

Two lengths of 45x95 timber next to one another are 90 mm thick, so I bought a load of stainless steel coach bolts, 6 mm in diameter, and 75 mm long. That would give me enough length to go right through one length of timber, and a decent way into the second piece. These have a hex bolt end and so, to hold the MDF down, I'd need something different – I eventually used eight 50 mm countersunk screws, but that's overkill. They needed to be long enough to go through the MDF and into the wood a short way, but the crucial point is that they →



Above ♦
If you're no good at cutting straight, a mitre box is a quick and easy fix

Left ♦
By doubling up the legs I gave myself more options for joining them to the top

FEATURE



Left ◆
To make the halving joint, mark and cut the width of a piece of timber on one end of a leg

were countersunk, so the screw heads would sit flush with, or slightly below, the work surface of the assembled bench.

Starting with five 2.4 m lengths of 45x95 spruce, I cut one in half to make two 120 cm lengths that would form the long sides of the bench, and the other four bits into 2x90 cm lengths, with each piece of timber yielding a spare part that was 60 cm long, minus the width of any saw cuts. At this point, my minimalist approach to tools let me down a bit. Cutting squarely

in straight lines is a knack that I don't have. I'd measured twice, and marked the top and front of the cut with a square, to ensure that I had a visual guide, but the muscle memory just isn't there. This may be expected in a beginner, but I did at least find a way around it: I used a mitre box, available for about £6,

Knotty Ash (spruce)

The wood I chose for this project is on the knotty side, which is fine for the most part, but does mean that I had to be careful where I put nails and screws, and where I made my cuts. I worked around this pretty well, but a couple of times I hit knots by accident, because I'd hidden the knotty side of the wood on the inside of the structure. It's counter-intuitive, but I should have left the flaws on the outside, so that I could avoid them.

to guarantee a straight, 90-degree cut. A power saw would have made the job even more accurate, but would also have cost a bit more than £6.

I then joined the 90 cm pieces together in pairs to make legs. I was using 6 mm

By necessity, I was using a pretty utilitarian construction style, but I wanted to add a bit of flourish

diameter coach screws, so clamped the two halves together and drilled a 5 mm pilot hole to reduce the chance of the screw splitting the wood, and screwed the coach screws in with an electric drill.

By necessity, I was using a pretty utilitarian construction style, but I wanted to add a bit of flourish, so I used my interpretation of a halving joint to join the legs to the top. Rather than take a thick, square leg and mark out, saw, and chisel away exactly the right amount of wood to fit another piece of timber to it, all I did was cut 95 mm off one of the two pieces of timber comprising each leg.

I next laid the MDF on the floor and laid the 120 cm and 60 cm pieces on it, to visualise where everything needed to go. It

became apparent that the 120x60 cm MDF was actually more like 122 cm by 66 cm; this didn't matter though, because I'd not taken into account the width of the timber when I cut it up. There was no way I was going to cut the MDF: it's made of short particles glued together that, when cut with a saw, are released directly into your lungs. So, I measured the timber to the MDF, and trimmed each piece to make a neat rectangle.

Using the floor as a flat surface, I stood the MDF on its side, and clamped one of the short 60 cm pieces (now more like 52 cm) flush with it. That flat edge established, I drilled two pilot holes through the MDF and into the timber – 3 mm this time, to fit a 5 mm diameter screw – and widened the hole with a countersink bit, before driving two screws. With this repeated on each side, I had a pretty good benchtop.

With the top upside down on the floor, I balanced the legs in place at each corner. Amazingly, there was no rocking and no wobbling; just a good, square connection



Right ◆
With the frame and support struts laid out, the table top was beginning to take shape

with 42.75 cm square wood-to-wood connection (95 mm x 45 mm), and the same area of MDF to wood connection. Apart from feeling like a 'proper woodworker', this is why I wanted to use a faux halving joint – when I'm working at the corners of the finished bench, the force is going straight down through MDF, to wood, to wed to the floor. Simply screwing or bolting 2x4s onto a rectangular frame would put shearing force open to the bolts. 6 mm stainless steel is probably stronger than me, but now that it's finished, I like knowing that there's nothing between my mallet and the earth but wood.

Two screws through the long length of the frame into the wide face of the leg, and one screw through the short end of the frame into the narrow part of the leg, and I now had a bench – or at least, I had a table. The next step was to make it useful. I found a load of vices on Gumtree for maybe £15 less than a new one, but that would have required around £15 of petrol, and three hours drive to go and get, so I went for a new one. The model I chose attaches to the edge of the bench through bolts or screws running vertically, and to get the edge of the vice anywhere near



Left ✦ I should have put this knot on the outside where I know I won't drill into it accidentally

Below ☑ Three coach screws at each corner hold things together

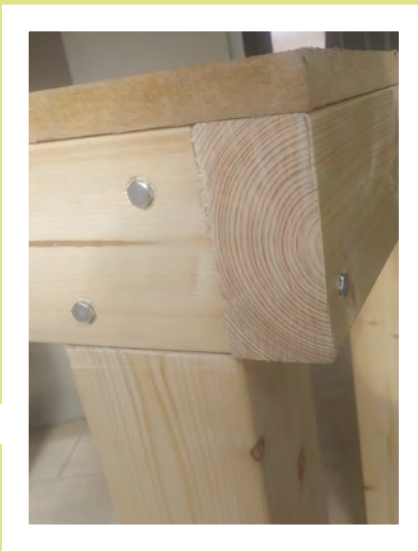

close to flush with the benchtop, I had to remove some wood from the bottom edge of the frame.

THE HOME STRAIGHT

This was the most fun part of the job: I measured an area the width of the vice, and marked a depth of 3 cm to remove. Then I made several relief cuts, and took one of the chisels you'd normally use for opening tins of paint to bash the chinks of wood away, before levelling the whole area with a file. Primitive, yes, but it's not cabinet making.

The reason I wasn't too bothered about making the metal jaws of the vice flush with the top is that I knew I would add a bit of softwood to the surfaces inside the vice; these give you better grip than the bare metal, and ensure that you don't mark whatever it is you're working on. By nature, these are disposable, but they'll work better when they're planed flush to the top.

Finally, to hold larger pieces lengthwise, I needed to add an apron with holes for bench dogs. I used 18 mm dowel cut to a length of about 5 cm, then cut a step out of one end of the dowel, so that it will hold the edge of a straight bit of wood – it's an extra step, but it will work better than leaving the dowel round. To accept the bench dog, the apron (which is just nailed into the legs) needs holes drilled into it. There are various patterns for this; I ignored them, because if I need a hole, I can drill one, as and where I need it. Now to make something with it! ☐

Below ✦ I needed a pair of thick washers to fix the vice to the underside of the table – so I made my own



DON'T MISS THE BRAND NEW ISSUE!



SUBSCRIBE FROM JUST £5

- FREE! 3 issues for the price of one
- FREE! Delivery to your door
- NO OBLIGATION! Leave any time

FREE PI ZERO W STARTER KIT*

With your 12-month subscription to the print magazine

magpi.cc/12months

* While stocks last



**WORTH
£20**

Buy online: store.rpipress.cc



BUILD, PLAY, WIN!



Vilros Raspberry Pi 3 Model B+ Retro Arcade Gaming Kit With Retro Gaming Controller Set
~~\$114.99~~ \$109.99



Vilros Retro Gaming USB Classic Controller Set of 5
~~\$39.99~~ \$37.99



Vilros Raspberry Pi 3 Model B Plus Retro Gaming Kit with 2 Gamepads & Fan-Cooled Retro Gaming Case
~~\$89.99~~ \$85.49

Check out more Retro Gaming products at www.vilros.com

USE THE CODE **RETRO** FOR 5% OFF

M ♡ ☞ ♣ ☹
Crack Coupon Code for **ADDITIONAL 20% Savings!** *

Restrictions Apply ***Offer Expires May 31, 2019**



THE BEST PROJECTS FROM HACKSPACE MAGAZINE

THE ULTIMATE SKILLS, TRICKS, AND MAKES

£12.99

FREE WORLDWIDE SHIPPING

BUY TODAY AT STORE.RPIPRESS.CC

Making exceptional costumes for exceptional kids



Costumes are for everyone



Krista Peryer

[@missladygeek_](#)

Krista is a cosplayer and craftswoman with a list of ongoing projects longer than Daenerys' titles on Game of Thrones.

Warning: the following story contains tales of happiness capable of tugging at your heartstrings, possibly even causing you to shed a tear, or two. This author did.

Reese Davis of Olathe, Kansas was born in 2005 with news that would change the course of his family's lives: he was born with cancer on his spine. Reese spent his first year of life at Children's Mercy Hospital in Kansas City. After learning that the cancer had crushed his spine, Reese would need to rely on a wheelchair; he received his first wheelchair at three years old.

For Halloween that year, his dad, Lon Davis, asked Reese what he wanted to be for Halloween. When Reese replied that he wanted to be the beloved character from his favourite movie, *WALL·E*, Davis set out to make it happen. And thus, before Davis even realised, Walkin' & Rollin' Costumes had laid its ground floor.

Using a Dell computer box, tape, paint, plastic parts, and a whole lot of love, Davis got to work on making a *WALL·E* costume that would fit over little Reese in his wheelchair. After posting the costume to friends and family on social media showing an elated Reese in his *WALL·E* costume, soon people began contacting

Davis directly about costumes, which spawned the idea to create Walkin' & Rollin' Costumes.

Walkin' & Rollin' Costumes, formally founded in 2015, is a father/son team 501(c)(3) non-profit organisation with a huge heartfelt motto: "Exceptional costumes for exceptional kids". The organisation provides free costumes to kids in wheelchairs and walkers, and with costumes such as the *Ghostbusters* Ecto-1 car, the *Hogwarts Express* train, and the *Scooby-Doo* Mystery



Right ♦ It's always the disaffected janitor

Above ▣ Reese Davis' first wheelchair costume



Above ⬆
Attempts to reach platform 9 3/4 are ongoing

Machine, exceptional is definitely a word we'd use to describe their work.

Year after year, Halloween would come along and Reese would request an even more elaborate costume, bigger and better than what Davis had done before, challenging him to perfect his designs, and learn what materials work and don't work throughout the process. Having had a few years to work out details on materials, Davis learned that 3mm PVC plastic sheets made a suitable and rigid alternative material to cardboard, and that EVA foam is a great product for builds that require a pliable material. As for the designs, those can be found inside Lon Davis's head.

IN THE BEGINNING

Davis went to college to become a 2D Disney Animator but found himself in a very different field than what he'd planned. After college, he went on to work in Business and Marketing, and until Reese's WALL-E creation, he hadn't considered how much his roots would ultimately still be a part of his life. After the newspapers and internet had started releasing stories on the costumes he and Reese had been developing over the years, those illustration skills became even more useful when Davis began receiving requests from people all over the country to



Above ⬆
Proton-packs at the ready!

build their child a wheelchair costume. By 2014, those stories also caught the attention of Kansas City's huge comic convention, Planet Comicon, who reached out to Davis to invite the family to showcase their builds.

At the time, there wasn't much behind the scenes at Walkin' & Rollin' Costumes, besides Davis's former builds and future build ideas in his and Reese's mind. When they were approached to be featured at Planet Comicon, they came up with a plan to help make costumes for others.

With each costume costing Davis an average of \$250, there was no way to afford the cost to make

Reese would request an even more elaborate costume

costumes for kids all over the country, so they developed marketing material for their booth at Planet Comicon with the aim to get donations and volunteers. Davis recalls a touching story of the first customer who visited their booth that weekend at Planet Comicon in 2014: "The first customer to visit our booth when the convention opened that weekend was an old man in a wheelchair. He sat there for a while, looking at the costumes we had on display, all the while, never speaking. After some time of studying, he laid \$100 →

Below ⬇
Lon fulfills a wide range of requests



FEATURE



Above ▣
Adding wind power

Right ◇
Ride on!

Below ◇
Tie Interdictor
made by the Olathe
North West High
School Team



unusual build, moulded from EVA foam and coated with truck bedliner spray to give it texture. Its legs moved up and down, with rollerblade wheels attached so that the costume would seamlessly roll along with Reese.

SOCIAL SUCCESS

When Davis posted the Ant-Man costume to social media, it spread like wildfire. The magic of social media quickly spread the video, with the *Ant-Man* director catching word of it and showing it directly to Paul Rudd himself while they were on set. The special effects director reshared it, gaining 1.2 million views in just under 24 hours.

Rudd, who is from Overland Park, Kansas, visits Kansas City every year for the Big Slick, an annual weekend-long celebrity fundraising charity event held for the cancer centre at the Children's Mercy. The event brings in massive crowds and donations, features a celebrity softball game at the Kansas City Royals baseball field, followed by a Kansas City Royals game. In 2016, the year of the Ant-Man costume, Reese got to meet his idol in person when he was asked to throw the first pitch to Rudd at the Kansas City Royals game. While meeting Rudd for autographs, Reese handed the picture of him wearing his Ant-Man costume to Rudd for him to sign. Shocked, Rudd responded "This is you?! You were the one in the video! Someone showed me this while I was on set!", and thus began a pen pal friendship between Rudd

on the table and spoke: 'I sure wish I could've had something like this when I was young,' marking the first donation to go towards making a costume for a child outside the Davis home. While it was their first success at securing donations and a few volunteers, they still weren't financed to make costumes for all the requests that had been coming in.

In June of 2015, Davis launched a Kickstarter for Walkin' & Rollin' Costumes to try to raise \$1000 for that coming Halloween season's costume requests. The campaign reached the \$1000 goal in two days, with a total of \$3000 secured that wound up funding the costume designs for eleven kids that first year.

When we asked Davis what his favourite builds have been, he listed four off the top of his head: WALL-E, since it was the beginning of Walkin' & Rollin' Costumes; the *Ghostbusters* Ecto-1 car (which played the *Ghostbusters* theme song); the *Back to the Future* DeLorean; and the Ant-Man costume. Davis says the ant's body for the Ant-Man costume was an





and one incredibly happy kid. Davis said Reese and Rudd have remained pen pals throughout the last four years, with the Davis family even travelling this year to a comic convention in Chicago, Illinois called C2E2 to set up a booth for Walkin' & Rollin' Costumes, getting to see Rudd again, who was there as a celebrity guest.

Davis says the relationship with his son and Rudd is so incredibly heartwarming, one that makes all that they've created with Walkin' & Rollin' Costumes even that more memorable.

Celebrity status aside, Davis says that while they've been able to successfully make most of the costumes requested at this point, there are still times where they are unable to make a request happen due to shipping costs, such as the parents from the UK who recently reached out to him to make their child a costume. Davis says they've got a volunteer base set

Davis believes that his projects should be open-source

up in the US, the cost of shipping the costume once finished is often the biggest hurdle to overcome. To combat this, Davis hopes that more places will start up their own local chapters of Walkin' & Rollin' Costumes. The costumes can often be constructed in separate pieces to ship with assembly instructions

upon arrival, but costs can still be quite high. At times, Davis faces this obstacle in true maker fashion by working with parents to design and guide them on making the costume themselves. Davis believes that his projects should be open-source, and he's always willing to lend a hand. When we asked him details about starting up local chapters, he stated that no matter the location, every chapter is branched under Walkin' & Rollin' Costumes, and they are always there to assist chapters along the way.

Walkin' & Rollin' Costumes also work with schools and organisations, as well as hosting annual workshops in the Kansas City area where volunteers can work as a team on several different builds. This set-up allows for multiple builds to get done in a weekend so that kids get their costumes in time for Halloween that year.

As for Reese, (who's not quite so little anymore at 14-years-old), he's now in remission. He still loves spending time with his dad creating new ideas for fantastical costume builds, penpalling with Paul Rudd, and being a happy kid with a life full of exceptional possibilities.

If you'd like to set up a location for exceptional children in your country to receive their own exceptional costume, Davis would be thrilled to have you reach out to Walkin' & Rollin' Costumes about developing a local chapter. You can get in touch via their website, walkinrollin.org.



Left ♦ It's the attention to detail that makes costumes special

Below ♦ First Ant-Man Costume for Reese Davis

Credit Chuck Mason Photography

Bottom ♦ Reese Davis in his Ant-Man costume with Paul Rudd and Reese's little brother at C2E2





HackSpace magazine meets...

Allen Pan

Builder of cool stuff, and YouTuber extraordinaire...

You might have heard of a hip new thing that the youth are calling 'YouTube'. People post videos of cats, for the entertainment and

distraction of the masses. It's great fun.

Allen Pan is one of these people – only instead of cats, he makes videos of homemade lightsabers, plasma swords, flying mythical hammers, and voice-activated flamethrowers. His stuff is ridiculous and brilliant in equal measure, and it got him onto the rebooted *MythBusters* TV programme. He's also a real-life engineer, inventor and, as of recently, a social entrepreneur. We asked him, in no particular order, what it's like to have your own makerspace, be rejected for a patent, and to shoot children with a 300 V Nerf gun taser. →

Left  Getting shot with Allen's home-made taser is like licking a battery with your whole body

Hackspace Morning Allen! That's a fancy-looking gun you've got there.

Allen Pan It's my taser Nerf dart gun! Each of these Nerf darts has a 300-volt camera flash capacitor. It doesn't hurt that bad; it's more like something much heavier than a Nerf dart hit you. It also burns the skin where the copper contacts hit the skin.

I wanted my own transformer as part of the charging circuit, because I'd always wanted to try doing that. And I finally had access to an oscilloscope because I have my own makerspace now. And, because I have the oscilloscope, I can see what's going on in there.

Beforehand, I would try and build something that has to work with a step-up transformer by eyeball. I had no idea what was going on. So, it's nice to be able to see the waveform, and know that it was actually working.

I've done two of these; the first one I made used the smaller Nerf darts, with two little prongs as contacts, and those didn't actually electrocute – well, technically that means kill, but it doesn't shock you at all. You get hit by one of those and you couldn't really feel anything. And that's because these are in contact with you for such a short amount of time. Human skin has such a relatively high resistance, of a few kilohms at best. So I decided to make the contacts really big, so that the surface area means that when it hits, even though it's only briefly touching, it's able to dump a great load of that energy into your flesh, so you can feel it.

HS If any of our readers get the Discovery Channel, they might have seen you on *MythBusters*. For the benefit of those non-watchers, what is it, and what myths do you bust?

AP Most people know *MythBusters* best as the original show that ran for 14 years with the two main hosts, Adam Savage

and Jamie Hyneman. The premise of the show was that they were finding myths and urban legends. Old wives' tales, like 'you can use Coca Cola to clean the engine of a car', or something like that. Really blue-collar wisdom. They would proceed to test it in sort of a spiritually scientific way that was also fun to see on camera.

The show was rebooted, and they wanted to find new hosts to carry the torch on after Adam and Jamie. So they had a reality show on the same network, on the Science Channel, they called it *MythBusters: The Search*, which ran for a season, had two winners, Jon Lung and Brian Loudon, and I did well enough that I was able to appear on the first season of the new rebooted *MythBusters* for three

I realised that I was never going to be able to build the things on this list unless I had some kind of incentive

episodes or so. But that show ended up being cancelled – cancelled or not renewed, it's all the same difference, they didn't get a second season unfortunately. People were so loyal to Adam and Jamie that they just couldn't ever see there being new hosts.

HS That makes sense. People are loyal to things they remember from childhood.

AP I think the sort of other example would be *Top Gear*. That one might be more familiar to the Brits. But *Top Gear*, I think they went with the right strategy. They got new hosts, people revolted, but the producers stuck with the new guys, and now the show is still going and people have accepted the new hosts. A new audience has come in and seen the new guys and gone, "yeah, this is fine".

HS From your YouTube channel, we guess that you're a Marvel fan. There's a lot of Stark-esque tech in there.

AP When I made the Thor's Hammer video, I wasn't planning on being a full-time YouTuber. That was never the plan. Basically I had, and still have, a list of projects that I want to do; ideas that I want to try out, or want to see if something from a movie, or sci-fi, or a comic book could be done in real life. And so, I realised that I was never going to be able to build the things on this list unless I had some kind of incentive. So I thought OK, I'll start a YouTube channel, and I can kind of make it like Colin Furze. At that time he was my inspiration, the guy I wanted to be like. He was the big guy who was making all the stuff on YouTube, and he was pretty much the only one at the time.

I thought that would give me the impetus to build things because now I was like, maybe on the weekends I can do this stuff, film it, it gives me a drive, and an excuse to build these things, and then maybe, I was thinking, someday it'll pay for the materials, because Thor's Hammer was originally about \$300 of stuff. I

thought maybe, someday I could get \$300 from a video and that would be self-sustaining. It had 7 million views in the first week. It was making me a few thousand dollars – at the time, that was more than I was making from anything else. I was a broke person working in makerspaces and stuff. And so I was like, "well, I guess I'm a YouTuber now".

That was the second video I ever put on YouTube. I made a channel called Sufficiently Advanced as a reference to "Any sufficiently advanced technology is indistinguishable from magic" – the quote from Arthur C. Clarke – to highlight what I wanted to go for with what I was making: real working versions of these fantasy creations.

The hammer had an electromagnet inside that I had made out of an old microwave oven transformer. It had →



Above  We recommend you watch the Science Channel – it's good for busting myths and learning about science



four lead-acid batteries. The electromagnet would keep the hammer stuck on a metal surface, like a manhole cover, so other people wouldn't be able to lift it, and then I would walk by, put my thumb on the handle, and be able to lift it really easily.

There's a throwaway line in *Avengers: Age of Ultron* where they're all sitting around trying to lift Thor's Hammer and Tony Stark is being cheeky, and says something like that literal translation of the enchantment on the hammer is that whosoever has Thor's fingerprint can lift the hammer.

And so that was the video, that was the project that turned me into a person who does YouTube videos for a living. It was bonkers, completely insane. I think it's had somewhere in the region of 30 million views or something.

HS What were you doing before then?

AP The thing I was doing immediately before making

Mjölfnir shows that where the money goes in the world is not always the best place. So, previously, I was doing work for various makerspaces, teaching workshops, coming up with a curriculum, running summer camps and stuff, lots of kids' educational-type things.

I actually tried to start my own business around this thing I invented called Conductak. So Conductak was an electrically conductive sticky tack. The idea was that I just wanted a way to put electric circuits together really easily. Whenever I was doing like electronics class in a library or a classroom, you cannot have 30 soldering irons. Even if you could, you don't want to give all 30 kids a soldering iron. And even for adults, breadboards are very confusing.

So, I just wanted a thing that would stick components together. There was nothing like that. There were a couple of

conductive paints, but nothing did what I wanted it to do. So I tried to invent some stuff of my own. I got this prototype that worked OK, and I was approached by a teacher who was teaching a class of blind and visually impaired students at a local high school.

She'd noticed that my demos were tactile – they were things you could put together with your fingers without having to use a soldering iron. You can't really feel the holes on a breadboard: they're very small and not very accessible. I had one project in particular that was a laser-cut trumpet with an ATtiny85 embedded into it with Conductak with a speaker, and you could press the buttons on the trumpet and

play the notes that a trumpet would play. And she's like, "This is great, you can put it together with your hands and the output isn't an LED, it's a sound; so many maker projects use blinky LEDs,

which isn't effective for somebody who's blind or visually impaired."

And so, I got a micro-grant from the Awesome Foundation. I went to this high school for a few weeks to develop this learning platform. I created educational devices and kits that blind and visually impaired students would be able to use to put together circuits, and actually culminated in what I called the circuit stick, I think. It was basically this circuit board that had these sort of laser-engraved, rebased schematic diagrams on it. We also printed off embossed circuit diagrams – because a circuit diagram, each of those elements has a specific symbol that works visually but also works tactilely. You can feel a resistor if it's printed on embossed paper. And then, if you have a corresponding board that has holes and it has that same symbol engraved or etched into →

"

That was the project that turned me into a person who does YouTube videos for a living

"

it, you can more or less figure out that that's where the resistor goes; if you've got Conductak, you can kind of stick it in place.

My patent was rejected, but on the plus side it's on the public record, so other people can't patent it either. It's just a mixture of rubber and graphite, and I wanted to figure out a way of doing it with metal powder, so you do higher-power things. It worked OK for LED stuff. I never went anywhere with it, but I can give you the recipe if you want to do something with it. I still think it's a good idea. Didn't get as much traction as putting a magnet in a hammer, though.

HS I'm given to understand that you get a bit of grief from idiots on the internet.

AP I think it's mostly like, erm, if anything the most number of complaints I've gotten recently have been for another channel I was on, and I did a series called *The Science of Mortal Kombat*.

HS And can you really rip a man's spine out?

AP Exactly! The characters in that video game do some very outrageous and, frankly physically impossible, things to kill each other, and we test to see how ridiculous those things really are. The comments section for that series was very harsh in the methodology; basically, you know, we had to decide various ways of doing things and people had some complaints about that. The assumption is always that we were lazy; it's like the whole *Game of Thrones* thing right now, where people are criticising the 'lazy' writers. Are you kidding me? These people are working on this show and you don't like the show and that means that they're taking it easy? They're showing up to the writers' room, they're hungover, crooked sunglasses on and wearing bathrobes, and making stuff up? You think that's how it happens?

Just because you don't agree with choices that have been made, doesn't



Above ♦ Stuck for place to do a bit of laser cutting? Why not take over your own local maker space?

mean that the person made those choices because they were lazy.

Other than that, I think just being a dude helps a lot. Being a woman on the internet is an entirely different experience. And then, like, being a Chinese American, honestly I think people got used to it. At the start, there were comments that were less than nice about my appearance, but after I got a couple of videos out that all got a million views, honestly that doesn't really show up any more. I think people just got used to me existing. "This guy again! I already made fun of him for being Asian; am I going to keep doing that? I guess not." It dies down after a while, I didn't have to do anything.

Being on *MythBusters* reopened that, though. There was a lot of stupid stuff on *MythBusters*. People were saying things like, "Oh they just need an Asian guy and a redhead, because that was the previous *MythBusters*, they had an Asian guy and redhead." There was one comment in particular that said, "You know one of the minorities are going to win because they need it for the ratings." How do you know that they haven't set up one of the white guys to win because they need a white guy? You would never have a *MythBusters* with no white dudes – they would never do that. So how come you aren't applying your affirmative action logic the other way around?

HS What are you up to these days?

AP I took a hiatus for five months. The reason I was doing that was because I was developing my own makerspace. In Van Nuys, California, there was a makerspace called HexLab Makerspace. I'd gone there a couple of times, just to use the laser cutter.

It was in the process of shutting down actually. In October 2018 HexLab was going to close down and the director still hadn't told anyone, which was a little untransparent – I was like, dude,

your members are going to show up one day and it's just not going to be here. And he was like, "Well, if you're interested, you could just have the makerspace, I'll give it to you. I'll sign over the papers and it'll be yours."

There was no debt, there was no cost, I didn't have to pay for anything, but yeah, it was now – this is your makerspace.

Something I found out really quickly was that there was no infrastructure in place there. I don't know how this guy had managed to actually have a makerspace for that long, but there was nothing there.

It was also in the process of liquidating, unfortunately. So all the 3D printers were gone, they don't have a welder any more, and I took it over and

I can rebrand it as Sufficient Space – the first makerspace in the world that's tied to a YouTube channel

was like, OK I can keep this makerspace afloat, I can rebrand it as Sufficient Space – the first makerspace in the world that's tied to a YouTube channel. I'm raising funds right now for a few things – basically the moving-in costs and the costs of renewing our insurance, and the costs of providing STEM programming for kids in the community for free.

They're giving us like \$1000 for some tools, but I'm sure you understand \$1000 for tools doesn't go very far. A MIG welder is 500 bucks right there. All the Kickstarter is for is to get us back to zero. I wasn't asking for a whole lot, just enough to get us back on the ground.

The makerspace is functionally a [tax-exempt, not-for-profit organisation] and so we do have a mission to provide to the community, and we currently can't do that if we don't have tools.

We haven't been able to provide outreach or programming for kids, especially as we have sort of bigger, more industrial tools. Our membership cut-off is 18 years, so we can't have any child members, but our insurance and our lease make it OK for us to have events where kids can come in. Part of the Kickstarter would fund a series of STEM classes for kids, for free, and that would be provided by two groups called the Two Bit Circus Foundation and the LA Makerspace. Because we don't have any money for instructors or curriculum, they would provide the teachers, the class and the materials, and we would pay them to do that. It's quite a nice partnership.

The makerspace, I've put in a lot of time to develop it, almost half a year. We have a board of directors, we have a lot of volunteers. I haven't been there for about three weeks now and it hasn't burned to the ground, it's been OK. The idea is to get it to a point where the makerspace is self-sustaining by its own community. We don't have money for staff, but we do have people who understand that if they don't volunteer at the space, then it won't exist. If it doesn't exist, then all of the

members who have some incentive to be there, they're all paying members and it's actually pretty expensive, because it's Los Angeles. It's because they all have small businesses, or they don't have room in their apartments for their own workspace, or they understand that there's a value in that space, just being around it.

We don't advertise it as such, but part of the value in being part of that makerspace is that you get to be there and there's an expert machinist working ten feet from you, and if you've got a question, that's a free consultant there: that's gold. It's not something that we can sell because I don't want to turn all of our members into part of the product for each other, but it's there. The community is there as a resource for each other. ▣

Cool tools for wearables

Consider adding these useful tools to your wearable electronics toolbox

There's nothing like having the right tool for the job. In the experimental world of wearables, sometimes the right tools come from unexpected places! In this deep dive, we'll look at our favourite tools for making wearable projects, and why we love them.

You don't need fancy tools to make great projects, but it's helpful to know what's out there. Some items on our list are necessary basics, and others are simply great to have on the occasions

that you need them. Look for our handy icons to spot the tools we think are essential, multi-use, or special-purpose.

Wrapping technology around the human body is an exciting fusion of electronics and fashion, and brings new challenges to both worlds. Your wearable electronics toolbox will likely contain useful tools from both these disciplines, as well as some custom tools you'll make yourself. Working in a new field means you are on the cutting edge, and the right tool might not exist until you invent it!

E Essential

M Multi-use

S Special-purpose



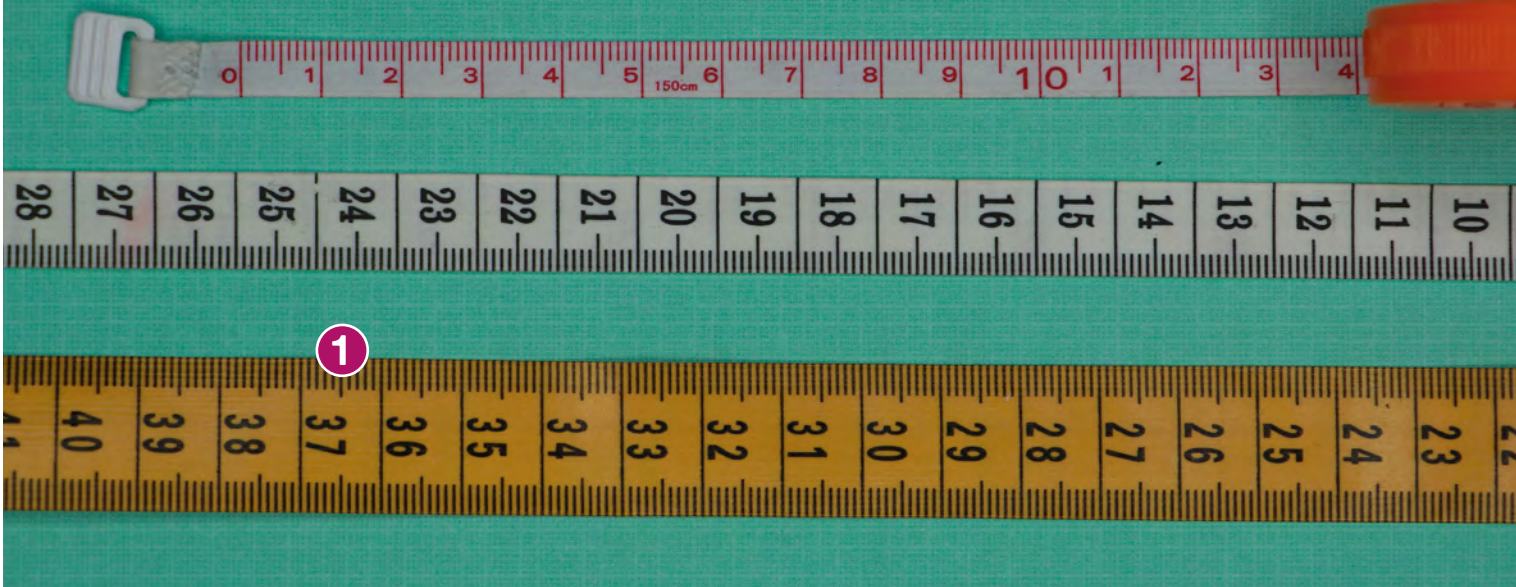

MEASURE TWICE

Make sure you take accurate measurements

When building a project for the human body, measurements are the key to a perfect fit. In addition to a basic ruler and yardstick, these measuring tools will help you get your dimensions right.

① CLOTH TAPE MEASURE E

A flexible cloth measuring tape is essential for taking accurate body measurements. A retractable measuring tape won't turn into a tangled knot, and is handy for carrying with you to the fabric store or out on an inspiration hunt.

② CLEAR RULER

A clear ruler makes it easy to take measurements from existing garments and objects. Clear quilting rulers have handy lines for marking seam allowances and tricky angles. Once you use a clear ruler for measurements, you'll wonder why anyone would ever measure with an opaque one.

③ SEWING GAUGE S

This super-useful tailor's tool takes the tedium out of marking seam allowances. You can also use a sewing gauge to quickly shift a line or transfer a measurement from one part of your project to another. The tool looks like a cross between a ruler and a calliper. To mark a seam allowance, set the slider to match your seam allowance, then hold the gauge perpendicular to your stitching line and slide along it, marking every few centimetres. Then, just connect the dots! →

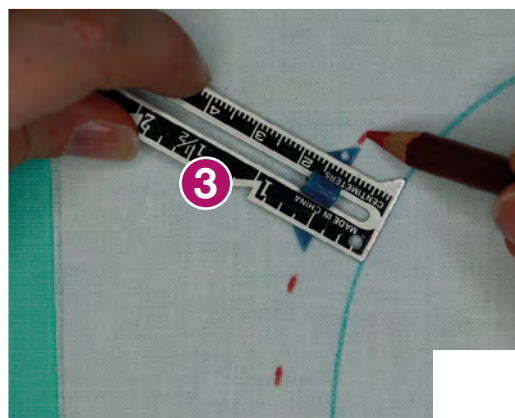
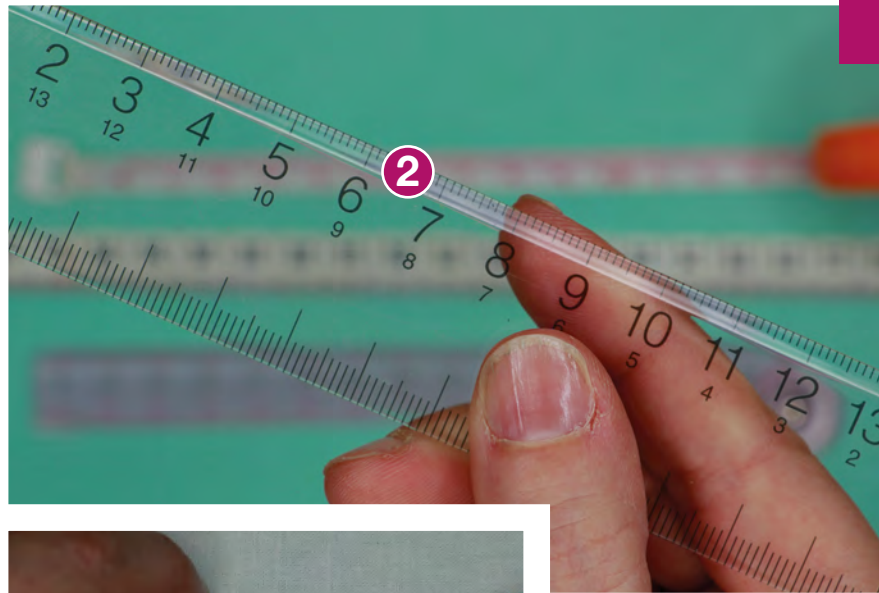

Above ♦
A clear ruler is great, but never use one with a craft knife

Left ♦
A sewing gauge is ideal for marking seam allowances



MAKE YOUR MARK

Different ways of marking your measurements

Above ♦
Choose the right
marker for the
material used

To mark measurements on fabric, a sharp pencil or ball-point pen may suffice. Coloured pencils are inexpensive, work well on woven fabrics, and you can use different colours for cutting lines, seam allowances, and other important markings. If you want your marks to be removable, consider these options...

① WATER SOLUBLE PENS

These pens usually contain blue or purple ink, which may or may not be visible against the colour of your fabric. Removability varies, and you'll want to test the pen on a scrap of your fabric to make sure it will remove completely with water. Let your test piece dry completely before pronouncing the test a success – in some cases, the ink can reappear when dry. Do not use this type of pen on dry-clean-only fabrics, such as silk.

② TAILOR'S CHALK

Chalk is a great solution for making marks on fabric that may be sensitive to water, like wool, because in

most cases the lines can be simply brushed away. Again, test on a scrap of fabric first. Tailor's chalk comes in palm-sized pieces or in pencil form, and can be easier to see on dark fabrics than water-soluble pens. Chalk is best for woven fabrics, but can be used with knit fabrics if care is taken not to stretch the fabric as you draw.

③ FRIXION PENS ^M

These erasable pens by Pilot contain ink that becomes invisible when heat is applied. The pens feature an eraser tip for use on paper: rub the eraser over the ink until friction-generated heat renders the ink invisible. But they're great for fabric too! Instead of the on-board eraser, use an iron to apply heat to your lines when you no longer need them. The lines disappear before your eyes, and it really does feel a bit like magic! As always, you should test the ink on your fabric first, and also note that exposing the marks to cold temperatures can make them reappear.



Above Scissors are fine, but they're not the only cutting tools around

CUT IT OUT

Tools for cutting fabric and other materials

Few tools are more perfect than a sharp pair of scissors. To keep yours in top shape, keep one pair for use on fabric only and a separate pair for paper. Label them clearly so you don't get them mixed up, and your scissors will know what their jobs are!

① ROTARY CUTTERS

If cutting a large piece, or many simple shapes, a rotary cutter can make your cuts more accurate and save time. Always use a rotary cutter on a cutting mat large enough to extend beyond the shape you're cutting.

② SEWING SHEARS AND SNIPS

You can cut fabric with regular craft scissors, as long as they are sharp, but if you will be working with fabric often, you may want to invest in a good pair of knife-edge dressmaker shears. Gingher is a classic brand known for making high-quality shears that can last for generations with proper sharpening. Dressmaker shears feature an offset handle designed for cutting fabric on a table. Resting their weight on the surface

of the table makes for beautifully straight cuts. For clipping threads, a pair of palm-sized thread snips is efficient and easy to use.

③ CRAFT KNIFE AND CUTTING MAT

While not great for fabric, a craft knife is perfect for cutting craft EVA foam, which is a very useful material for wearable projects. Using a cutting mat does more than just protect your work surface: it also keeps your blade sharp longer, and gives you more control for accurate and safe cutting.

④ SEAM RIPPER

This tool is invaluable for adding electronics into garments. In many cases, you will want to route wires behind the lining of a garment, or into an existing pocket. Opening a seam will cause less damage than making holes in fabric that can unravel or fray. Use existing seams as much as possible in your projects, opening them with a seam ripper, and then hand-sewing them closed when you are finished. →

SAFETY WARNING

Never use a plastic ruler as a straight edge for cutting with a craft knife. The soft plastic can catch the blade and steer the blade toward your hand. Always use a metal straight edge when cutting!



Above Numerous adhesives are available, suited to various materials

MAKE IT STICK

Sometimes the hardest part of a project is figuring out how to stick things together!



1 GLUES E M

Hot glue makes it into almost all of our wearable projects in one way or another. Use it for everything from attaching components to insulating a soldered connection. If you need to rework the soldered connection later, apply a drop of rubbing alcohol to the edge of the dried glue and peel it away. Cyanoacrylate glue is handy for keeping knots tied in conductive thread. And E6000 is a strong industrial adhesive that remains flexible when dry, and can be washed. Always wear a respirator when applying toxic glues like E6000, and let dry in a well-ventilated area or outside.

FUSIBLE WEB S

Kind of like double-sided sticky tape for fabric, fusible web is a thin film of adhesive that is applied with heat. Sandwich it between two pieces of fabric,

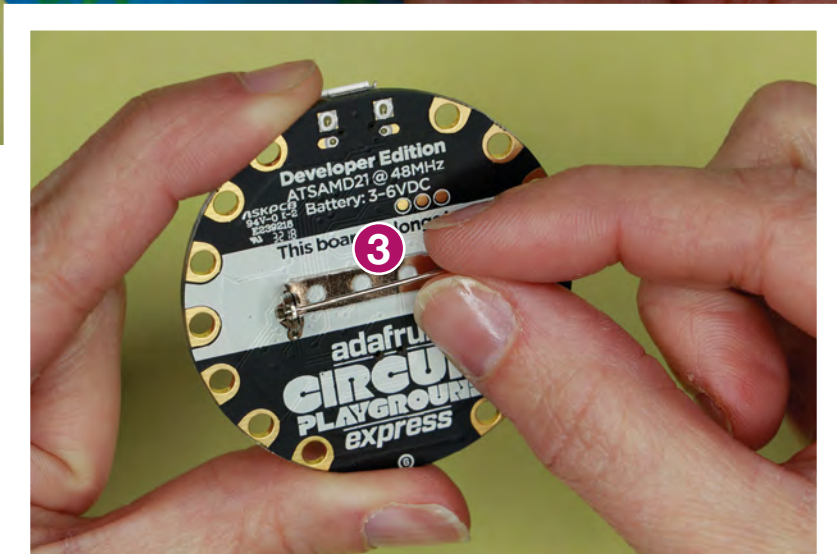
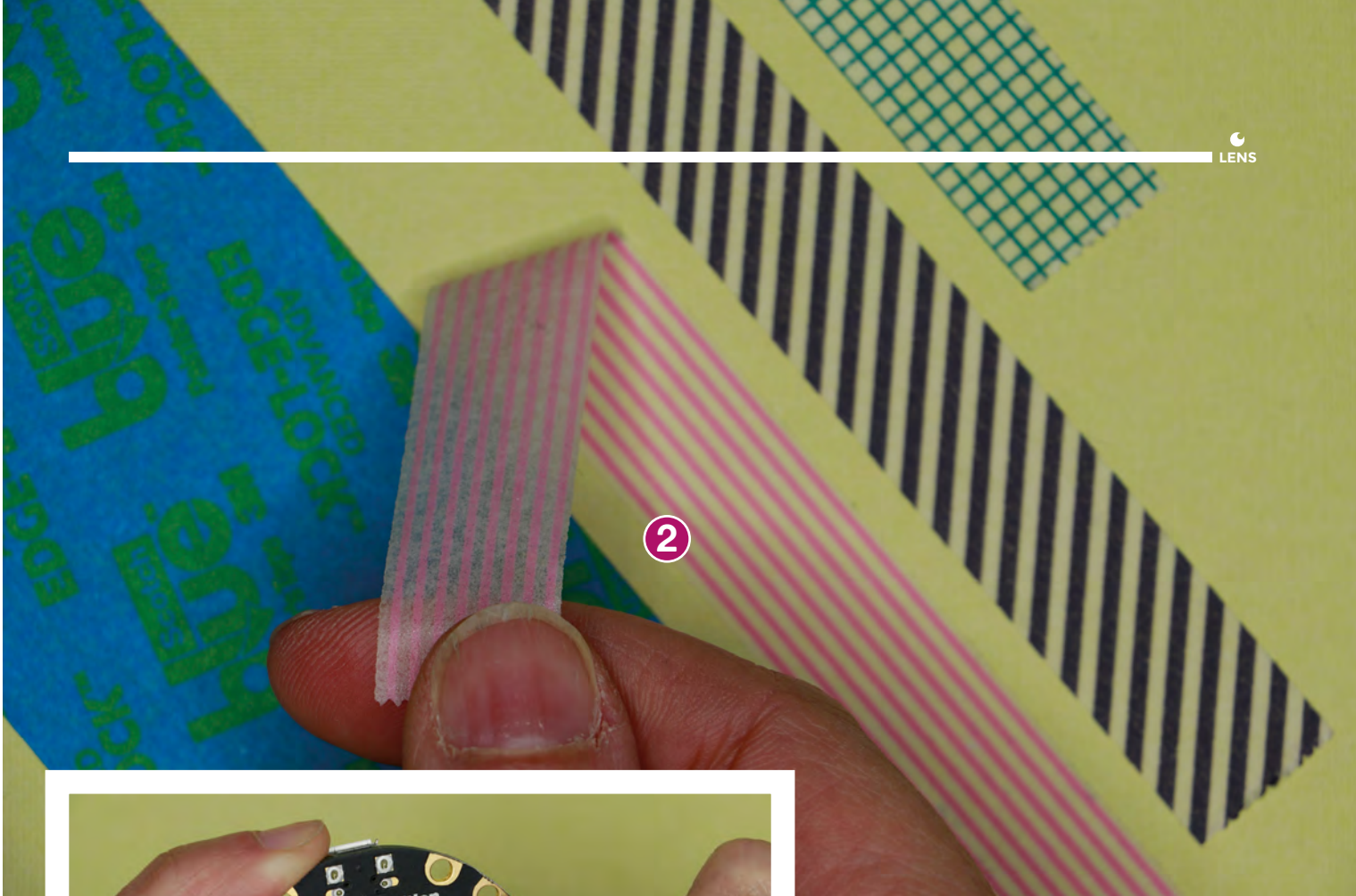

iron with a press cloth, and the fabrics become fused together. Follow manufacturer's instructions for application and washing.

HOOK-AND-LOOP FASTENER

Hook-and-loop fastener is endlessly useful in wearable projects. Just be careful to keep track of the hook (rough) side, as it can catch on things and damage soft fabrics. It's good to have both sticky-back and sew-on varieties on hand. The sticky-back type of hook-and-loop may work well on rigid surfaces like plastic and metal, but for a mechanical bond to fabric, you'll want to sew it on.

② TAPES E M

Masking tape, or blue painter's tape, is useful for creating patterns from rigid objects like helmets and

shoes. Cover the item with tape, draw your pattern, remove the tape in one piece, and cut out. When you need a more permanent bond, double-sided foam tape is great for sticking microcontrollers and components to rigid surfaces like plastic. Electrical tape and Kapton tape are handy for insulating circuitry, and gaffer tape can add another layer of protection to a LiPo battery. Japanese washi paper tape in different colourful patterns makes it easy to label wires, and can be written on with a pen or pencil.

③ MAGNETS AND PIN-BACKS

To temporarily install electronic components in garments, consider name-tag magnets or pin-backs. Keeping your electronic components removable means you can wash your garment and keep your project forever! →

Top ■
Tape comes in many types, from masking to electrical

Above ◆
Pin-backs make it easy to detach components

FEATURE

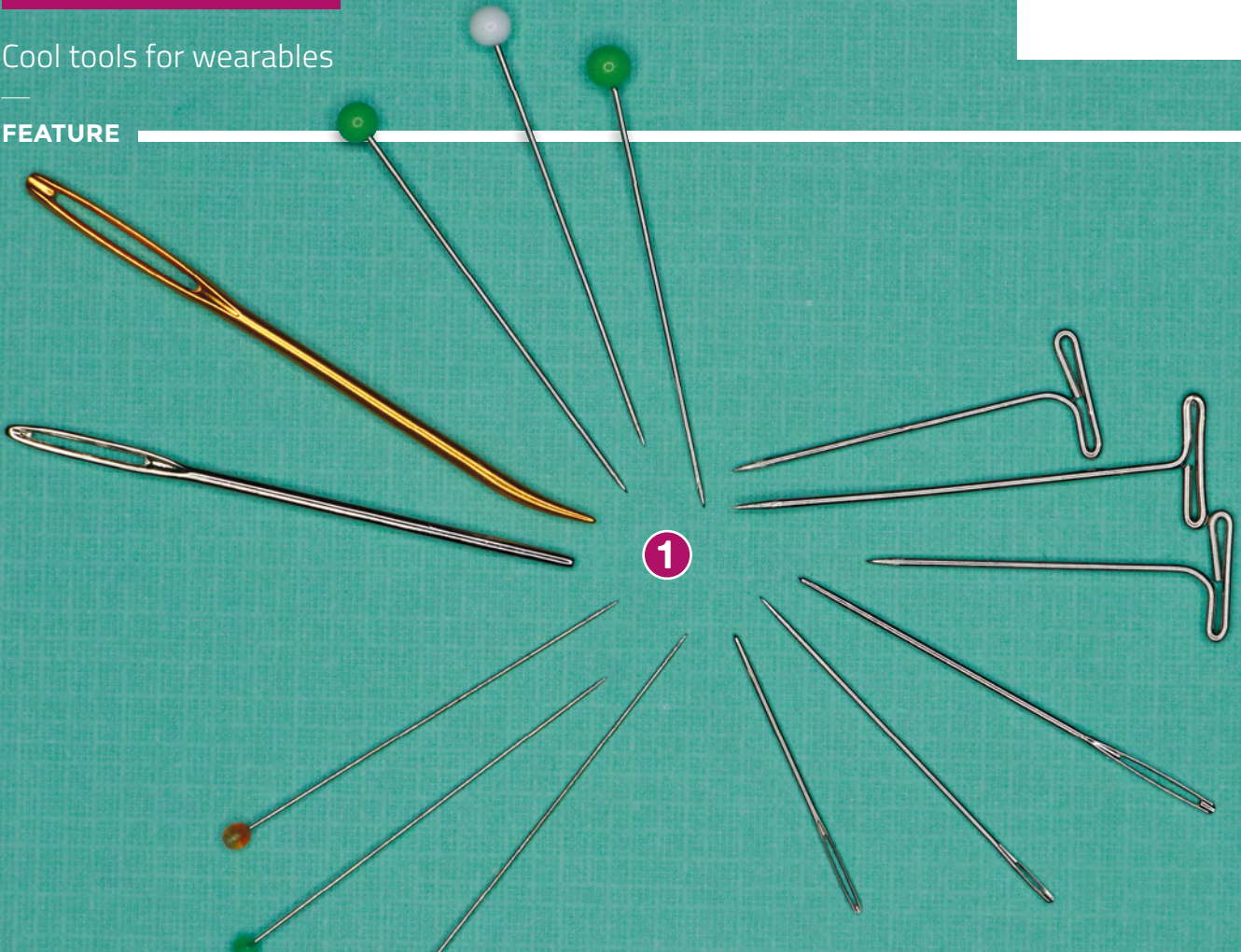

SEW AWESOME

Use sewing tools to stitch fabric and hold things together

A sewing supply store is a treasure-trove of tools and gadgets, with everything from point turners to button covers. Here are our top picks for wearables tools from the sewing store.

HAND-SEWING SUPPLIES E

Large-eye needles make it easy to thread regular and conductive thread. Blunt darning needles or yarn needles are perfect for feeding tiny silicone wires through casings and seams. A little beeswax applied to conductive thread can make sewing with it more manageable. A thimble is a necessity when pushing a needle through thick fabric. It takes time to get the hang of sewing with a thimble, but once mastered, your fingers will thank you.

SEWING MACHINE S

You don't need a fancy sewing machine to make amazing textile projects, you can make almost anything with just a straight stitch and a zig-zag. Think battery pack holders, arm bands, casings for NeoPixels, and more. If your sewing machine can make buttonholes, you've got a quick and easy way to make bound holes in fabric – perfect for wire pass-throughs!

1 PINS AND NEEDLES

There is a staggering array of different types of pins out there and, again, you can get by with simple straight pins for most projects. T-pins have a wide bar that makes them easy to grab; use them for pinning into styrofoam, cork, and foam board. Fork pins are good for tacking multiple layers of fabrics together, and there's an almost infinite list of uses for the good old safety pin. For knit fabrics, use ball-point pins to avoid snagging the fibres and creating runs in your fabric.

Likewise, when choosing needles for hand or machine sewing, use sharps or universal needles for woven fabrics, and ball-points for knits. Use a denim needle when working with heavyweight fabrics like denim or canvas, and use a special leather needle – with a wide, knife-edged tip – for sewing through leather. On your sewing machine, change your needle often, every time you start a new project. When your stitches have issues, a dull needle is often the culprit.

2 CLIPS M

When you can't pin, clip! When working with leather, any pinholes you make will be there forever. Instead of pins, use clips. Household clothes-pegs are easy

2

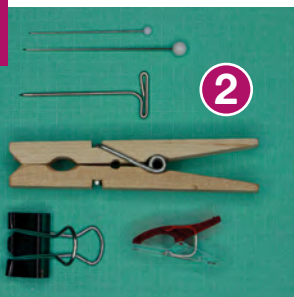

Top ■
Pins and needles come in different shapes and sizes

Above ◆
When working with leather, use clips or pegs to hold it

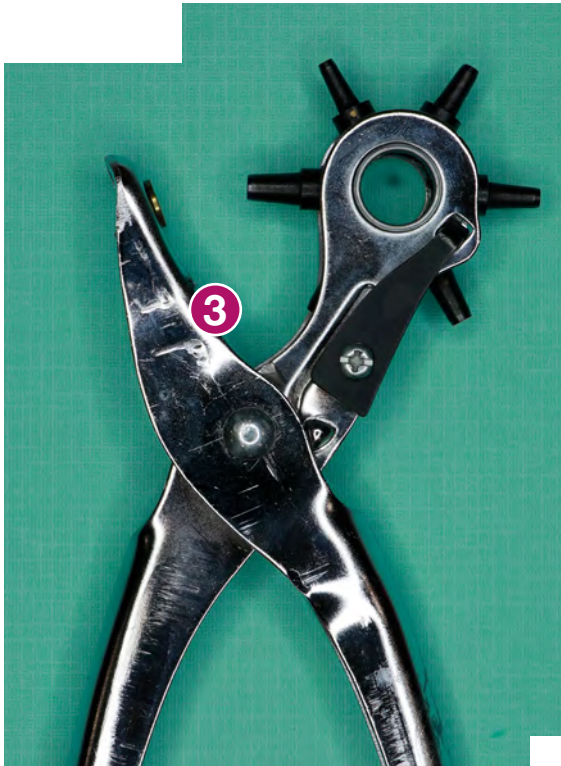

to use, gentle on the surface of the material, and you may already have them in your junk drawer. Binder clips have a strong grip, offer a wider gripping surface than clothes-pegs, and come in several sizes. Clover's Wonder Clips feature a flat underside for sliding across the surface of your sewing machine while you sew.

③ AWL AND LEATHER HOLE PUNCH ^S

At some point, you'll need to make holes in your garments for passing wires. Cutting or punching holes into woven and knit fabrics causes fraying, runs, and damages the fabric. When possible, use an awl instead to work a hole between the fibres large enough to feed wires through. For leather, a leather hole punch with multiple sizes works well.

④ IRON ^E

If you're currently sewing without an iron, prepare to up your game dramatically. Use the appropriate setting for your fabric, and keep the surface of your iron clean. Wrinkles in fabric look messy and make it impossible to cut your pattern accurately. Press your fabric before laying out your pattern, then press every seam as you sew twice. Press once over the seam as it was sewn, then open the seam flat and press the seam allowances open. This makes your seams strong and beautiful. A small craft iron is great for getting into tight nooks and crannies, or applying narrow strips of fusible interfacing over conductive thread traces.



PRESS CLOTH AND TEFLON PRESSING SHEET

When pressing conductive fabrics and other synthetics, or when applying fusibles, use a press cloth to protect the fabric and keep your iron free of residue. A press cloth is just a small piece (think two sheets of A4 paper, side by side) of white or unbleached woven cotton, like muslin. Place the cloth over the fabric and press directly on top of the press cloth. When dirty or scorched, wash or discard. We love Teflon pressing sheets: they're reusable, smooth, translucent (so you can see what you're pressing!), and can last up to ten years under normal use.

FRAY CHECK ^E

This clear liquid is a must for unfinished fabric edges. A little goes a long way: dab some on along a raw edge to keep it from fraying, and place a drop on thread knots to keep them tied tight. If dried Fray Check in the bottle's nozzle closes it up over time, carefully poke it with a T-pin to clear it.

When two creative fields like electronics and textiles come together, innovation abounds. It's especially exciting for creators coming from one field to the other, discovering another rich world of tools to play with. Sometimes, just knowing a tool exists can bring new possibilities and spark ideas. And in the end, it'll be your idea that makes the project great, not your tools. So let your ideas fly – when you can sew and solder, you can make just about anything! ▣

Left ◆
A leather hole punch with multiple sizes

Above ◆
Craft irons enable you to get into the nooks and crannies



MARBLES



Mayank Sharma

[@geekybodhi](#)

Mayank is a Padawan maker with an irrational fear of drills. He likes to replicate electronic builds, and gets a kick out of hacking everyday objects creatively.

Go grab the old can of swirlies from the attic

Children across civilisations, from the ancient Egyptians and the Romans, have quarrelled over these simple orbs.

In these times though there wouldn't be a lot of us who've actually won marbles by rolling, throwing, and knuckling them against an opponents'. Playing marbles doesn't enjoy the same status as a sporting competition as it once did, though it's still in vogue in some parts of the world. The British and World Marbles Championship is one of the most popular international tournaments that's built around playing marbles. It's held every year on Good Friday in the UK, at the Greyhound pub in Tinsley Green, near Crawley.

Playing marbles were originally made of stone and clay, until glass became the raw material of choice in the 19th century. The change began in the late 1840s

with the invention of a mould to make marbles by a German glass-blower. By the end of the century, the manufacturing process had been automated, and the first marble-making machines made their debut in Germany, and then the U.S.

The marble-making process begins by melting recycled glass, with rejected marbles, inside a kiln that's heated to 1200 degrees Celsius for about 16 hours. The molten glass is then poured out of the kiln, and a shearing device cuts the stream of flowing glass at regular intervals, forming segments called slugs that'll eventually become marbles. The shearing device can be adjusted to cut at shorter or longer intervals to change the size of the marbles. These slugs then slide down chutes and land between grooves on a pair of spinning cast iron rolls, and are shaped into orbs by the rollers. The spinning keeps them from sticking to each other, and cools them in about 72 hours.

The intricate marbles with various patterns inside them are handmade. Marbles most commonly are about 1 cm in diameter, while larger ones that are over 8cm wide are also not uncommon. Besides being used for games, marbles are also often collected, both for nostalgia and for their aesthetic colours. A marble's worth is primarily determined by its material, size, condition, and appearance.

One of the most famous photographs of Earth was shot on 7 December 1972 by the crew of Apollo 17, and is captioned 'The Blue Marble' because that's how the Earth appeared to the astronauts. While marbles may have lost their place on the gaming pedestal, they've gained another as a utilitarian component in the improviser's toolbox.



MARBLE-O-LANTERN

Project Maker

KELLY TINKER

Project Link

hsmag.cc/hYjRVR

Living on a traffic-heavy street in Pittsburgh meant Kelly didn't get many trick-or-treaters. Instead of getting discouraged, the lack of footfall encouraged her to try something new. She tells us that

it was an old project she had seen a while ago, where someone had put marbles into a wooden fence to allow the light and colour to shine through, that got her started: "That project had been filed away in the back of our minds for a rainy day, and ended up coming in handy on a spooky day instead!" The basic idea is pretty simple. Hollow out a pumpkin, then drill holes in it with a sizeable bit and fill the

"IT'LL REALLY HELP SET A PUMPKIN APART FROM EVEN THE MOST ELABORATELY CARVED COMPETITION"

holes with marbles. You can drill the holes randomly or as per a planned pattern. Kelly says that she considers pumpkins as, "a great disposable medium to explore ideas in a unique combination of light and carved design." Kelly and her wife are skilled Jack-O-Lantern masters, and have created a couple of intricate designs on the pumpkins that look spooky when augmented with the glowing marbles. Kelly says the effort was worth it: "It'll really help set a pumpkin apart from even the most elaborately carved competition with both colour and glow. The only downside is rescuing the marbles from the pumpkin sludge if you wait too long after Halloween!" □



Above ♦

Kelly considers Halloween a maker's holiday and believes nothing will stop a maker from creating, "even if your audience is only five costumed kids."

TABLE LAMP

Project Maker
ARTENHARIA

Project Link
hsmag.cc/DCNFDo

Since marbles are made of glass, you can use the very transparent ones in a similar fashion as the first build.

And, what better way to make use of their property to allow the light and colour to shine through, than to create a lamp. In their YouTube video, they create the base with a 32×32 cm piece of wood and use a large popcorn bucket to trace a circle that's about 18 cm in diameter. Before proceeding further, watch their previous video (hsmag.cc/bEGVWH) to learn how to mount the socket for the lamp onto this wooden

base. When the lamp socket has been mounted, prepare small balls of epoxy, and use them to stick the marbles on the pencilled circle. After laying one row, use two balls of epoxy to stick the second row of marbles on top of the previous one. Continue the process until you've created eight rows, and you're done. □

" PREPARE SMALL BALLS OF EPOXY, AND USE THEM TO STICK THE MARBLES ON "



Above ♦
For an even cooler effect, you can try and use marbles of different colours

CRACKED MARBLE CHARMS

Project Maker
ANASTASIA

Project Link
hsmag.cc/cVdMUJ

Right ♦
Cracking marbles is a dangerous process. Please exercise caution and use safety goggles and oven mitts while baking the marbles

Cracked marbles are quite the rage and enhance the ornamental value of the tiny orbs, which make them fit for all kinds of arts and crafts projects.

You'll find lots of different techniques to crack marbles, which basically involves heating the marbles in an oven and then cooling them rapidly. As the hot outer shell cools, it strikes the hot expanded interior and cracks it to create the effect. For the best results, Anastasia suggests sorting the marbles to make sure you use the ones that don't have any cracks and are clear and not opaque. She places them in an oven, preheated to 230°C for 15 minutes, before taking them out and placing them in a pot of ice-cold water, which should crack the interiors. Anastasia then wears these marbles in



a necklace. For this, she makes two loops at both ends of an 8" long wire, and curls them tightly until there's only about a 1 cm gap between the two loops. She then folds the loops over each other and glues the marble between them. Once the marble is set, use pliers to pull out the tiny loop at the top, through which you can thread the necklace chain. □

SOLITAIRE

Project Maker
ZACHARY GOODE

Project Link
hsmag.cc/cy10Hj

Right ♦
Zachary uses a mitre saw, a drill-press, and an orbital sander, but you can replicate the project using manual tools as well

If you aren't too fond of traditional marble games, here's an alternative.

Solitaire is a board game where the objective is to remove all the pegs from the board, leaving just one in the middle.

Zachary, a Robotics freshman at the Arizona State University, tweaked the game slightly to replace the pegs with playing marbles. His Instructables is all about creating the board that'll hold the marbles. He first cuts two 12" wide pieces from a walnut board and glues them together to create a 12x12" board. Once it's dry, he drills the indents as per the pattern of the puzzle. You can find the PDF for the template in his Instructables. He suggests you glue the template



onto the board and peel it off when you're done drilling the 45 indents. Make sure you skip over the last step of his Instructables where he gives out the solution to the puzzle. □

HackSpace

TECHNOLOGY IN YOUR HANDS

Download the app

Out now for smartphones & tablets



£2.29

rolling subscription

or

£26.99

subscribe for a year



FORGE

HACK | MAKE | BUILD | CREATE

Improve your skills, learn something new, or just have fun tinkering – we hope you enjoy these hand-picked projects

PG
90

STUD CLAMP

Hold threads without damaging them



PG
94

MONITOR POLLUTION

Make sure that the air you're breathing is safe

PG
100

TETRIS CLOCK

A colourful timepiece for your living room



PG
84

SCHOOL OF MAKING

Start your journey to craftsmanship with these essential skills

- 84 Power conversion
- 86 CircuitPython
- 88 Laser cutters

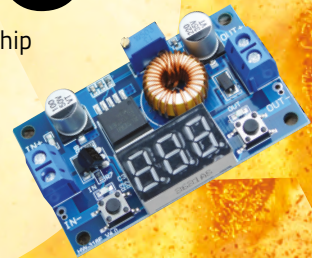

PG
106

WORKSHOP TIPS

Spin, cut, sand, and engrave with a rotary tool

PG
108

MODELLING MECHANISMS

Building without building using Fusion 360

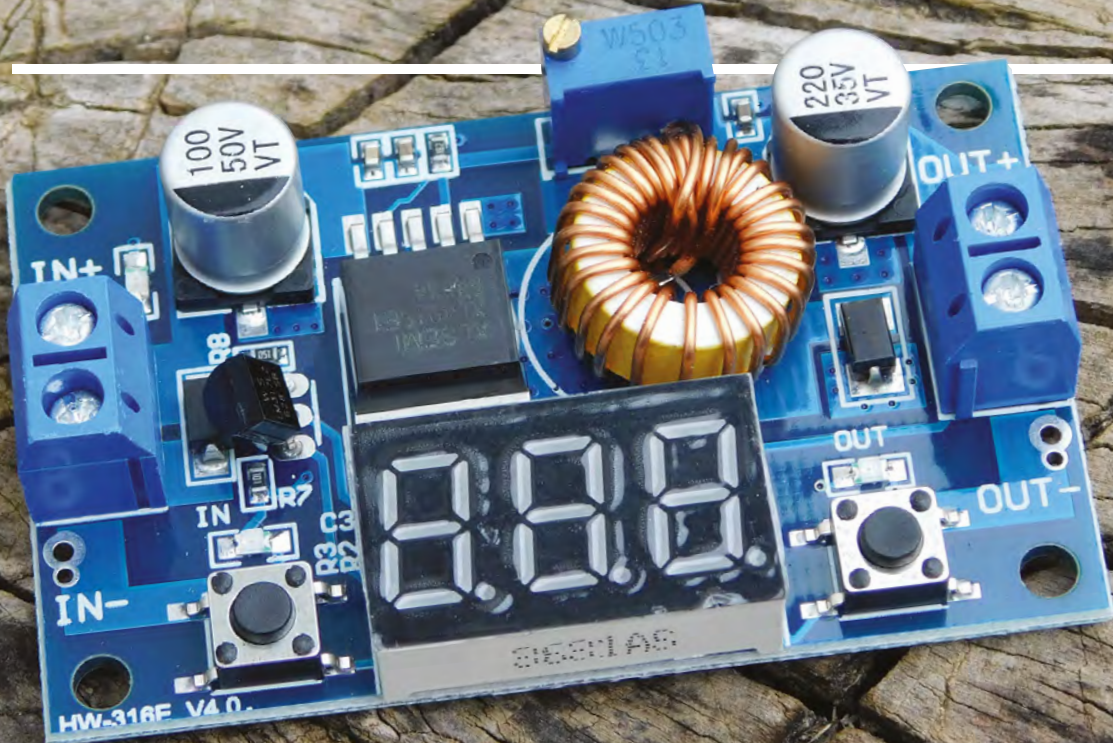

Power conversions

Changing voltages up and down



Ben Everard

[@ben_everard](#)

Ben loves cutting stuff, any stuff. There's no longer a shelf to store these tools on (it's now two shelves), and the door's in danger.

Electricity is made up of electrons moving through a circuit. The more electrons, the more electricity. We call this current, and current is just a count of the number of electrons moving past a point in a second. 1 amp = $6.241509126 \times 10^{18}$ electrons per second. However, electricity has a second property that's a little more tricky: voltage.

Voltage is one of those slippery properties that however we define in simple terms, someone will write in to tell us we're wrong. But, basically, it's what gives electrons their push to get around the circuit (hence its old-fashioned name: electromotive force). These two properties are intrinsically linked with Ohm's law that tells us:

$$\text{voltage} = \text{current} \times \text{resistance}$$

There's another way that voltage and current are linked: power. This is measured in watts, and equals voltage (V) multiplied by current (I):

$$P = IV$$

Power is further linked to energy, in that energy equals power multiplied by time. You may remember

from school that energy can't be created or destroyed, but only converted into one form or another. Electrical circuits are basically ways of converting energy into different forms (and may also perform calculations as a side effect of this). If you put one joule of electrical energy into an LED, you'll get one joule of light and heat energy out. The ratio of these two types of energy defines the efficiency of the LED.

As well as converting energy into different types, we can change the way it exists as electrical energy. Since we know that energy equals power multiplied by time, We can convert this to:

$$\text{Energy} = \text{voltage} \times \text{current} \times \text{time}$$

This means that, theoretically at least, it's possible to create a conversion where:

$$\text{voltage}_{in} \times \text{current}_{in} = \text{voltage}_{out} \times \text{current}_{out}$$

We can ignore the time values since we're considering a continuous conversion, so it's the same on both sides and therefore cancels. This theoretical conversion could, say, take 1 amp at 5 volts and convert it into 5 amps at 1 volt without breaking the laws of physics.

Above ♦
A buck converter module with a display showing the output power

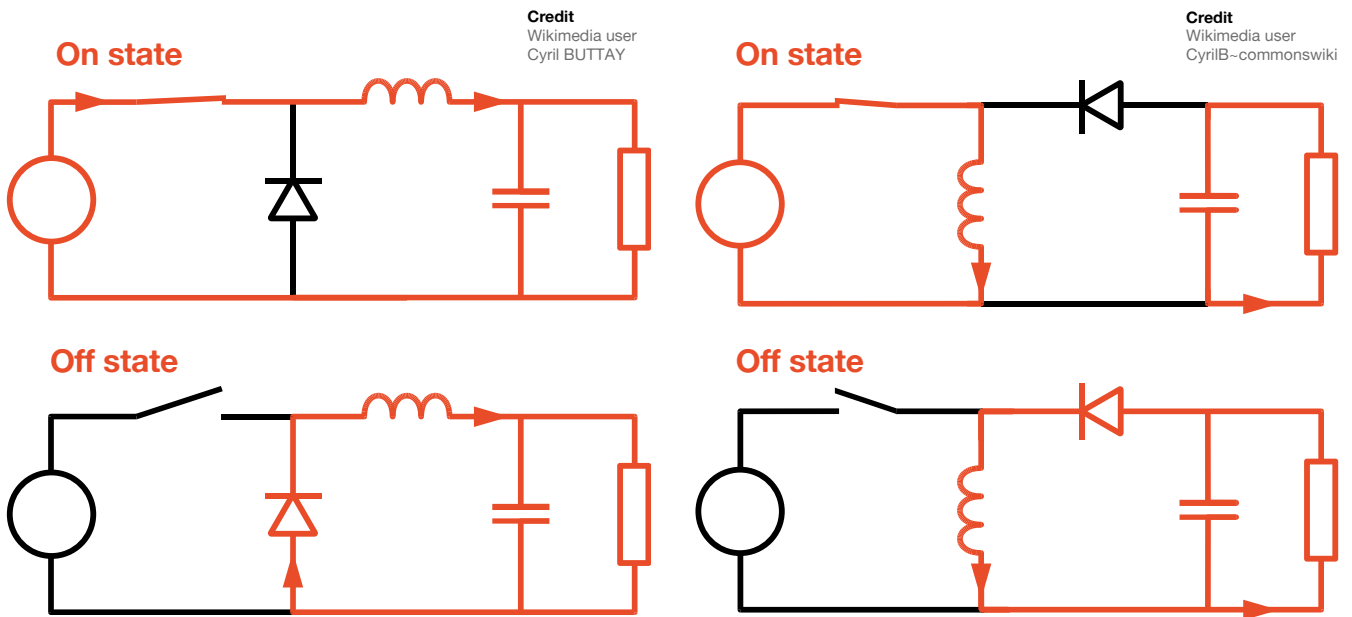

Credit
Wikimedia user
Cyril BUTTAY

Credit
Wikimedia user
CyrilB-commonswiki

Above ♦
In a buck converter, the inductor resists change in current and stores this energy in a magnetic field. Removing the power collapses this field and pushes power through the circuit

Above ♦
The boost converter connects the inductor to create larger rates of change in the current compared to the buck converter

Linear converter

This outputs the same amount of current that comes in but at a lower voltage. For example, a 3V linear converter will always output 3V regardless of the input voltage. Since the output energy is so much lower than the input energy, this energy has to go somewhere, and it's converted into heat. The bigger the difference between the input and output voltages, the more heat is created.

Buck converter

This circuit switches between two states (hence it's known as a type of switched-mode power supply). In the closed state, the power source will push current into the inductor. Inductors resist changes in current and create an opposing voltage (this is caused by energy being stored in a magnetic field). Once the switch is opened, there's no power into the inductor, and the magnetic field collapses, which creates a current into the load. By managing the switching (which in practice is done by a transistor), the inductor can be used to output a lower voltage to the input voltage (though it needs to be smoothed by a capacitor in order to be a smooth voltage), but at a higher current.

Boost converter

This is also a switched-mode power supply, and works in a similar method to a buck converter. However, the switch position is such that it induces much higher currents – and much higher rates of change in currents – from the power supply. This means that the inductor creates and destroys larger magnetic fields and therefore creates higher voltages. Since we can't magically create energy, though, the output current is smaller than the input current.

Neither boost nor buck converters convert 100% of the energy into electrical energy. They both have losses, and this level of loss depends on the particular voltage ranges being used, and the components in place, but it can be over 90% efficiency.

There's also a hybrid circuit called a buck-boost converter that can both raise and lower the voltages.

While the circuits themselves are fairly straightforward, creating a working converter requires a controller to manipulate the switch (or the transistor that's in place of the switch). While you could build this yourself, by far the easiest way of converting voltages (and therefore currents) is to use an off-the-shelf module. These are widely available for a few pounds apiece. You adjust the voltage out using a screwdriver to manipulate a potentiometer. Some have built-in voltmeters that display the current voltage, but on others you'll need to use your multimeter to check the output voltage before connecting it up to your circuit. □

CircuitPython storage

Save data to the flash drive for later retrieval



Ben Everard

[@ben_everard](#)

Ben loves cutting stuff, any stuff. There's no longer a shelf to store these tools on (it's now two shelves), and the door's in danger.

```

22
23
24 #Storage
25 start = time.monotonic()
26 try:
27     with open("/test.txt", "a") as fp:
28         for i in range(20):
29             fp.write('test')
30             fp.flush()
31     with open("/benchmarks.csv", "a") as bench:
32         bench.write("filesystem benchmark,")
33         bench.write(circuitpythonversion)
34         bench.write('{:0:f}\n'.format(time.monotonic()-start))
35 except OSError as e:
36     print("write error -- unable to perform filesystem benchmark")
37
38 #Neopixel
39 pixels = neopixel.NeoPixel(board.NEOPIXEL, 10, brightness=0.3, auto_write=False)
40 start = time.monotonic()
41 for i in range(0,200):
42     pixels.fill((255,0,0))
43     pixels.show()
44     pixels.fill((0,255,0))

```

While investigating the performance of the latest CircuitPython release, we wrote a program to perform some benchmarks and then save the results to the storage

so that it can be read by the computer the next time that the device is plugged in. Flash different versions of CircuitPython to the board and, voilà, we had all our benchmarks in one handy place.

Whenever you plug a CircuitPython device into a computer, it comes up as a USB storage device that enables us to read and write data, and it also runs the code on the device. This can cause a slight problem because USB mass storage isn't designed to allow two devices to access it at once. We need a way to set it so that either it's accessible to the computer, or it's available for our code to write to it. Fortunately, there is a switch on the Circuit Playground Express that we can use to select which machine we want to be able to access the storage at any one time. We need this to run before the main `code.py` script, so we can create a `boot.py` file that runs when the CircuitPython device is first powered on. Here's the code for the `boot.py` file:

```

import board
import digitalio
import storage
switch = digitalio.DigitalInOut(board.D7)
switch.direction = digitalio.Direction.INPUT
switch.pull = digitalio.Pull.UP
storage.remount("/", switch.value)

```

This code only runs after a full reset, not a soft reset. So, in order to change the access, you need to flip the switch, eject the USB device (if it's currently accessible to the computer), and physically press the reset button or pull out the cable and plug it back in.

With the Circuit Playground Express held with the USB port upwards, flip the switch left for computer access to the file system, and right for CircuitPython.

We'll then write our benchmarks to a CSV file. As we'll be writing data from many benchmarks, we'll need a function to handle this, and the function is as follows:

```

def write_out(markname, marktime):
    try:
        with open("/benchmarks.csv", "a") as bench:
            bench.write(markname+", "+circuitpythonversion+",")

```

Above This code also prints the values to the serial terminal, so you can view them in Mu (or another serial monitor)

```

    bench.write('{0:f}\n'.
                format(marktime))
except OSError as e:
    pass
print(markname, circuitpythonversion,
      marktime, sep=",")

```

This uses a few Python structures that we haven't looked at before. Let's start with the most-nested bit of code and work backwards. The following line opens the file **benchmarks.csv** in append (a) mode:

```
with open("/benchmarks.csv", "a") as bench:
```

Crucially, this creates an indented block of code that can access the file. Once this code block ends, Python closes the file.

In this block, we can call `write()`, which is much like `print()` except that it sends text to the file rather than the terminal.

The variable `circuitpythonversion` is set elsewhere in the line:

```

circuitpythonversion = str(sys.implementation[1]
[0]) + "-" + str(sys.implementation[1]
[1])+"-"+str(sys.implementation[1][2])

```

EXCEPTIONAL CODE

Above this we've got the block:

```

try
...
except OSError as e:
    pass

```

When CircuitPython is running, it occasionally encounters errors that it doesn't know how to process. These are known as exceptions. Usually, these exceptions will crash the program, and you'll get an error message on the serial connection with the exception details. However, if you know that a bit of code could cause an exception, you can wrap it in **try / except**. This format will run the code in the **try** section, and if it encounters an exception, it will skip to the **except** section. You have to detail the exception type you're expecting – in our case, we know that if the file system isn't writeable, it'll throw an `OSError`. Normally, the **except** block will do something like try a different way of performing the task, or clean up anything that may have been left in an untidy state, but we don't actually need it to do anything. Since Python needs at least one line in each code block, we've used **pass**, which is just a 'do nothing' instruction.

The full code for our benchmarking is available at hsmag.cc/DxIsRz, but let's look at a few simple tests.

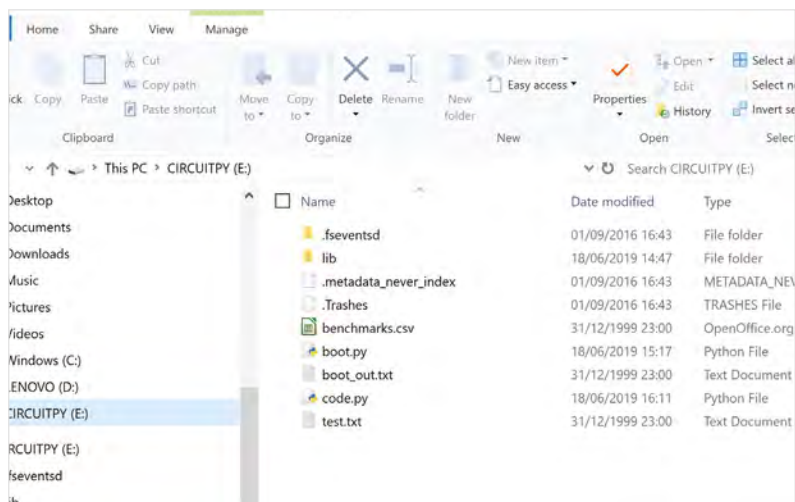

```

out = 0
start = time.monotonic()
for i in range(0,100000):
    out= out+i
write_out("integer sum", time.monotonic()-start)

```

The `time.monotonic()` method returns the number of seconds since some undetermined time. With this method, the absolute value is irrelevant, since we don't know when it's counting from. However, subsequent times are always relative to each other.

We can also test how quickly the board can interact with hardware, such as the on-board NeoPixels, which we test in the following code:

```

pixels = neopixel.NeoPixel(board.NEOPIXEL, 10,
brightness=0.3, auto_write=False)
start = time.monotonic()
for i in range(0,200):
    pixels.fill((255,0,0))
    pixels.show()
    pixels.fill((0,255,0))
    pixels.show()
write_out("neopixel flicker", time.monotonic()-
start)

```

This is a little painful on the eyes to watch, but it does a good job of putting the board through its paces.

This is how we tested different versions of CircuitPython, but you could use very similar code for logging almost any data, such as what you receive from sensors. Depending on which libraries you use, you should find yourself with at least 1MB of space for writing data on the Circuit Playground Express. That may not sound huge, but it's enough for 10,000 lines of 100 characters each, and other boards, such as the Grand Central M4 Express, have even more space available.

How does the latest CircuitPython perform? You'll have to read our review on page 128 to find out. ▣

Above ◆
Once run, you can open the benchmarks.csv file with any text editor or spreadsheet

QUICK TIP

There's more information on using storage on the Adafruit Learn guide at: hsmag.cc/AjHPNk

At a glance: Laser cutters

Laser control so accurate that even a Jedi would be proud



Ben Everard

[@ben_everard](#)

Ben loves cutting stuff, any stuff. There's no longer a shelf to store these tools on (it's now two shelves), and the door's in danger.

Laser cutters are expensive tools for home workshops, but they're a staple of hackspaces and makerspaces around the world, so if you're in a metropolitan area, there's a good chance that you'll be able to get access to one.

Most work in the same basic way: there's a laser and a two-dimensional control system that can move it about a workspace. The laser can be switched on and off, and between different powers which can cut and engrave different materials. Typically, you upload your design using vector art from software such as Inkscape or CorelDRAW, with different lines indicating different cutting or engraving powers. However, setups can vary, so make sure you know what format your laser cutter expects before trying to upload any artwork.

Here's the Trotec Speedy 100 laser cutter from the Raspberry Pi makerspace. Your laser cutter may be different but will probably have the same basic parts. Let's take a look at them. □

LASER

These come in many different powers. The smallest are around 1 watt. These are mostly used for engraving as they lack much cutting power, but with a bit of care, they may be able to cut paper. Most laser cutters (rather than engravers) are 40 watts or more. They vary in wavelength, but be aware that many are invisible to the naked eye. If laser goggles are an important part of your safety equipment, make sure that they match the wavelength of the laser you're using or they will be useless otherwise.

FAN

There are a few uses for air in a laser cutter. Blowing air across the cut makes it less likely to cause a fire. Also, laser cutting can give off some pretty nasty fumes, and these shouldn't vent into an enclosed space. Either the laser cutter should vent outside, or you should have a proper air filtration system to avoid gassing the user.

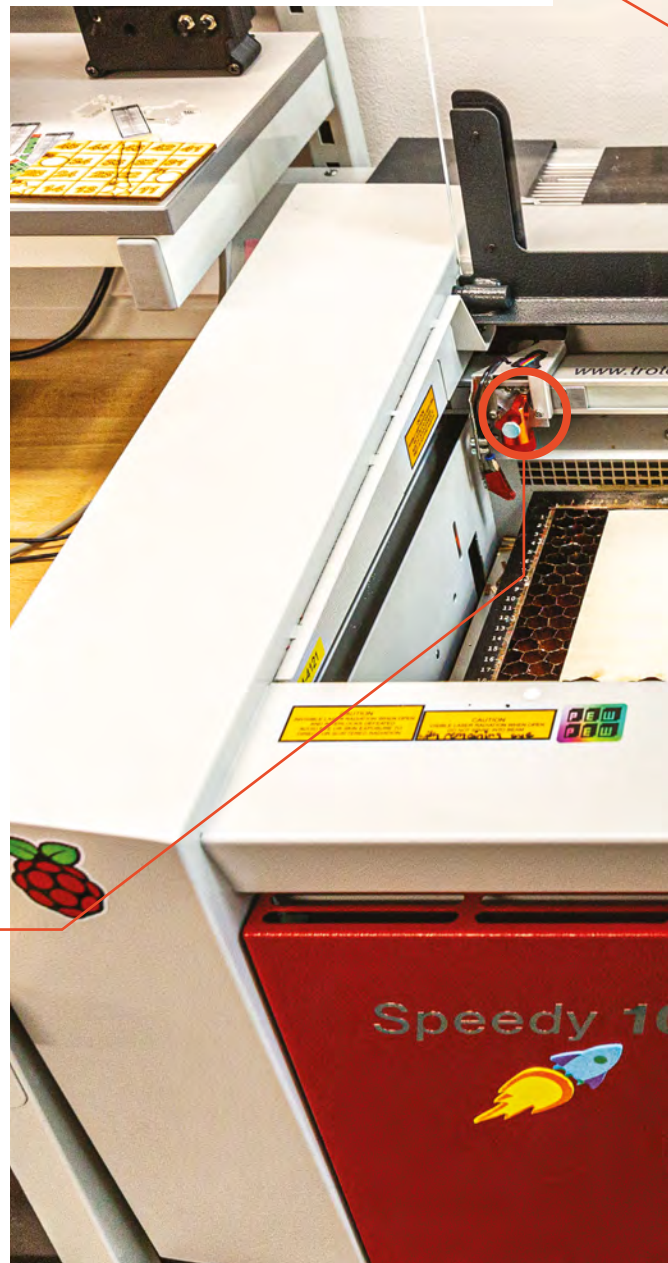

SAFETY COVER

This prevents people from getting in the way of an active laser. It does not block the laser, so if there's something reflective on the bed, the laser beam could be reflected back into the room causing injury.

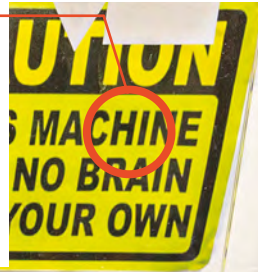

CONTROLS

These move the laser. The main direction controls move the cutter around. This allows you to position your cut/engrave at a particular point on the bed. In this image, for example, the plywood already has some bits cut out of it so you'd need to position the work to avoid this. The up and down arrows move the bed to bring the laser into focus on the material to be cut.



MATERIAL

Most material will engrave or burn when 40 + watts of photons hit it in a concentrated focal point, however, this doesn't mean that all materials are suitable for a laser cutter. A few things to consider are whether it will burst into flames easily, whether it will reflect the laser beam, and whether it will emit any toxic gasses. Take a look at your laser cutter documentation and the materials data sheet for reference, and if you're unsure, it's best to err on the side of caution and use materials that you know are safe.

BED

A honeycomb bed holds material flat and prevents pieces from falling through as they're cut, but at the same time provides good airflow and lets heat dissipate easily.



Figure 1 Three stud clamps of various sizes covering a range of threads. The one at the top is the one made in this tutorial

Making a stud clamp tool

Using what we have learnt about marking, punching, drilling, and tapping, let's make a super-useful workshop tool: the stud clamp



Jo Hinchliffe

@concreted0g

Jo Hinchliffe is a contributor to the Libre Space Foundation and is passionate about all things DIY space. He loves designing and scratch-building both model and high-power rockets, and releases the designs and components as open source. He also has a shed full of lathes and milling machines and CNC kit!

If you've ever had to hold a bolt or threaded bar in a vice to cut it to length, or some other operation, you probably realised that it's tricky to hold them without damaging the thread.

Similarly, trying to remove a threaded rod that is firmly stuck into something without damaging it is a nightmare, often resulting in choice words, broken tools, and further damage to the part. A great solution to both these problems is a stud clamp: a fabulous, simple tool that enables threaded sections to be clamped firmly, allowing them to be worked on without damage.

The stud clamp works by inserting a threaded bar into the threaded section and then clamping the slotted section of the clamp. Usually done in a vice for bench work, or with a set of grips for stud extraction, the clamp then firmly holds the threaded object without distorting or damaging it. This is a fun, simple project to make which uses the skills we learnt in previous issues 19 and 20, with the added challenge

of cutting a long, straight slit into the object centred through the threaded holes.

FEEL FREE TO MAKE THE DESIGN YOUR OWN

The design of the stud clamp is quite simple, and we aren't too concerned with exact dimensions – feel free to substitute in a different range of thread sizes to meet your requirements. In this tutorial, we will make a clamp with M3, M4, and M6 threaded holes as these are sizes used regularly. In **Figure 1**, we can see a couple of stud clamps made to accommodate sizes from M2 to M12 but, fair warning, cutting a slit through an M2-sized hole is quite a challenge!

ON YOUR MARKS

To begin, find a short piece of metal stock – we have used a piece of mild EN1A steel, 25mm wide and around 60mm long. We made sure to square the ends with a file so that we could accurately mark the



work. We covered the metal in permanent marker and then scribed a centre line onto which we will mark regular spacings for our hole coordinates. (The marking out techniques used here were covered in the marking out article in issue 19.)

While marking the centre line, mark two parallel lines to the centre line: one 1 mm below and one 1 mm above the line. These lines are for later in the process when we cut the slot into the clamp, and they will help us gauge if our cut is staying in line or not.



Using a smaller tap wrench for the smaller M3 thread can help you avoid breaking taps



Having marked the centre lines, let's mark four equally spaced lines at 90 degrees to the centre line; again, dimensions are not critically important – we settled with these lines to mark the hole centres being 10mm apart. We are cutting one extra hole which will form the end of the slot, as this makes the end of the slot more stable and less likely to travel; it also enables the stud clamp to flex and close to perform its clamping duties.

Having marked the lines delineating the hole centres, punch these points for the centre drill to pick up on to begin drilling the holes accurately. At this point, your workpiece should look similar to the one shown in **Figure 2**.

Using a good drilling technique (as learnt in issue 20), centre the drill, and then drill the hole for the smallest sized thread closest to the edge of the workpiece. Continue with the corresponding increasing drill sizes for the other holes for the desired threads. For the extra hole that finishes the slot, there



is no particular size requirement, apart from it should be larger than the slot itself; a 3–6 mm hole will be fine. We actually forgot to drill the extra hole in the excitement to begin tapping the holes, but we circled back to the drill press and drilled it afterwards.

Moving to the bench vice, tap each hole in turn – we covered tapping holes in issue 20, but just to say again here, make sure to keep the tap as vertical as possible when starting the thread. Also remember to turn the tap a ¼ turn anticlockwise for every ¾ turn clockwise to clear the metal chips into the ground sections of the tap, making it much less likely to jam or snap. If you're using a single tap, remove the tap and run a correctly sized bolt through the hole a couple of times to ensure the thread is clear of debris, and working well. If you're using a series of taps, make sure to use them in the correct order and, again, test the threaded holes with a bolt. If you have one, using a smaller tap wrench for the smaller M3 thread can help you avoid breaking taps by potentially applying too much pressure from a bigger set.

THE HIGH PRESSURE PART

Once we have all the holes correctly threaded, the final task is to hacksaw the slot through the holes to enable the tool to slightly reduce the size of each tapped hole when clamped. This is a tricky task if you aren't used to hacksawing, and there's the added pressure that you have invested a fair bit of work into the piece already by marking out, drilling, and tapping the holes. The best tip for this task is to not rush it. Don't make the error of pushing the hacksaw down too hard, causing it to bite into the work. Pausing regularly will give you time to check →

Figure 2 ♦ The workpiece, marked and punched ready for drilling

Figure 3 □ Tapping the M3 thread, using a smaller set of tap wrenches

YOU'LL NEED

- ♦ Pillar drill, or a drill stand
- ♦ Drill bits for M3, M4, M6 holes (2.2 mm, 3.2 mm and 5 mm)
- ♦ Small centre drill
- ♦ An M3, M4, and M6 tap, or sets of series taps
- ♦ Tap wrench
- ♦ Bench vice
- ♦ Cutting/tapping fluid (or at a push 3-in-1-type oil will do)
- ♦ File
- ♦ Wire wool or some fine sandpaper

Making a stud clamp tool

TUTORIAL

QUICK TIP

A slow, steady pace with the hacksaw is always recommended – less than one stroke a second is preferable. It's often said 40–50 strokes per minute is optimal.

Figure 4 ♦
Hacksawing the workpiece carefully, as near to the centre line as possible



that you are still on the centre line. If possible, arrange yourself so that your feet are planted firmly on the ground and you are standing at 90 degrees to the sawing angle, and that the work is held in a vice roughly level with the height of your elbow. Getting your body in position sets you up to make a straight cut rather than having to correct all the time. Begin sawing steadily, pausing regularly to check you are sawing straight down the centre line (**Figure 4**), and make small corrections if needed.

The two guidelines we scribed either side of the centre line should still be visible, and they should be

an even distance from either side of the hacksaw blade. If you opt to make a stud clamp for larger thread types, you can afford to be a little less accurate. But, for example, on the middle clamp in **Figure 1**, you can see we have made a stud clamp with an M2 threaded hole, which means that there is very little margin for error either side of the hacksaw blade. Continue cutting until you reach the final unthreaded hole. Once you have finished the slit, you can relax again and admire your work!

Using the stud clamp is quite straightforward, and they can be positioned differently for different jobs using a selection of clamps. The simplest way to use them is shown in **Figure 5**, where the stud clamp is held closed in a bench vice – fantastic if we want to work horizontally across the threaded item. For

FINISHING



QUICK TIP

As you approach the final unthreaded hole that ends the slot, take care that you are cutting flat across the work so that you don't damage the back of the hole when finishing the slit.

To finish the stud clamp, it's worth doing some gentle strokes of a file to deburr the hole edges on both sides of the stud clamp – and, as a habit for most workpieces, it's not a bad idea to 'soften' the edges and corners of it with a gentle file stroke. This knocks off any sharp corners and makes it more pleasant to handle. We then need to clean the remaining permanent marker and marking lines off the stud clamp. Some coarse wire wool (or a pan scourer) with a few drops of oil on it works well, or some fine emery cloth – again, with a few drops of oil – will polish the marks away.

Figure 5 ♦
Using the stud clamp in a vice to hold a small threaded bar securely, allowing the end of it to be filed square





example, if we had cut a section of threaded bar and wanted to tidy up / file the end, we simply spin the clamp onto the threaded object to the desired position and then place the slot end of the clamp in a vice and tighten. You'll feel with even a small amount of pressure from the vice jaws that the stud clamp firmly holds the threaded bar, and it cannot move or rotate in the clamp.

Some jobs will require that we hold the threaded object horizontally rather than vertically – we can use the stud clamp in combination with a couple of clamps to do this. As you can see in **Figure 6**, we have used the vice and a small toolmaker's clamp to achieve this so that we can clamp this machine screw in the required position.

GET CREATIVE!

Finally, note that you might want to make other stud clamps for a variety of different thread types. It's also worth noting that it's useful to make stud clamps for larger diameter threads out of thicker material so that you get a decent amount of turns of thread gripping the object – it's preferable to have over four turns of thread. Beyond this, you can play with the design as much as you like, the larger stud clamp in **Figure 1** has some practice counterbored holes in it, and also some spot-faced holes. The middle stud clamp in **Figure 1** has accurate gauge holes drilled and reamed to size to help identify the correct drill bit for M2, M3, and M4 holes, as these are often used in the workshop. □

Figure 6 ♦ Using a vice and additional clamp to change the orientation of the workpiece held in the stud clamp

Below ▣ Removing a cylinder stud from a vintage two-stroke engine from a seized nut



QUICK TIP

Pretty much anything that clamps and fits could be used on the stud clamp: engineer's clamps, mole grips, or even a small G-clamp.

Air quality monitor

Make sure your environment's safe



Ben Everard

@ben_everard

Ben loves cutting stuff, any stuff. There's no longer a shelf to store these tools on (it's now two shelves), and the door's in danger.

Air is the very stuff we breathe. It's about 78% nitrogen, 21% oxygen, and 1% argon, and then there's the assorted 'other' bits and pieces – many of which have been spewed out by humans and our related machinery.

Carbon dioxide is obviously an important pollutant for climate change, but there are other bits we should be concerned about for our health, including particulate matter. This is just really small bits of stuff, like soot and smog. They're grouped together based on their size – the most important, from a health perspective, are those that are smaller than 2.5 microns in width (known as PM2.5), and PM10, which are between 10 and 2.5 microns in width. This pollution is linked with respiratory illness, heart disease, and lung cancer.

Obviously, this is something that's important to know about, but it's something that – here in the UK – we have relatively little data on. While there are official sensors in most major towns and cities, the effects can be very localised around busy roads and trapped in valleys. How does the particular make-up of your area affect your air quality? We set out to monitor our environment to see how concerned we should be about our local air.

PICKING A SENSOR

There are a variety of particulate sensors on the market. We picked the SDS011 for a couple of reasons. Firstly, it's cheap enough for many makers to be able to buy and build with. Secondly, it's been reasonably well studied for accuracy. Both the hackAIR and InfluenAir projects have compared the readings from these sensors with more expensive, better-tested sensors, and the results have come back favourably. You can see more details at hsmag.cc/DiYPfg and hsmag.cc/Luhisr.

The one caveat is that the results are unreliable when the humidity is at the extremes (either very high or very low). The SDS011 is only rated to work up to 70% humidity. If you're collecting data for a study, then you should discard any readings when the humidity is above this. HackAIR has a formula for attempting to correct for this, but it's not reliable enough to neutralise the effect completely. See their website for more details: hsmag.cc/DhKaWZ.

GETTING STARTED

We picked the SDS011 sensor for our project (see box below for details on why). This sends output via a binary data format on a serial port. You can read this serial connection directly if you're using a controller with a UART, but the sensors also usually come with a USB-to-serial connector, allowing you to plug it into any modern computer and read the data.

The very simplest way of using this is to connect it to a computer. You can read the sensor values with software such as DustViewerSharp (hsmag.cc/dCgWlk). If you're just interested in reading data occasionally, this is a perfectly fine way of using the sensor, but we want a continuous monitoring station – and we didn't want to leave our laptop in one place, running all the time. When it comes to small, low-power boards with USB ports, there's one that always springs to mind – the Raspberry Pi.

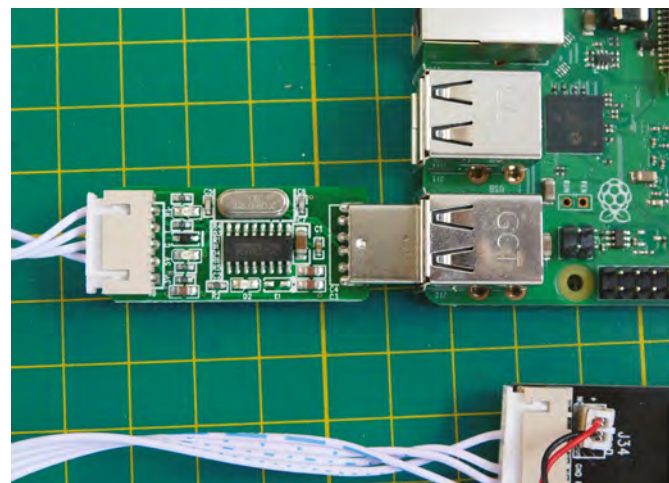

Above The USB-to-serial connector makes it easy to connect the sensor to a computer



Left ♦
The sensor and Raspberry Pi hooked up and collecting data

SAFE LEVELS

Once you're monitoring your PM2.5 data, what should you look out for? The World Health Organisation air quality guideline stipulates that PM2.5 not exceed $10 \mu\text{g}/\text{m}^3$ annual mean, or $25 \mu\text{g}/\text{m}^3$ 24-hour mean; and that PM10 not exceed $20 \mu\text{g}/\text{m}^3$ annual mean, or $50 \mu\text{g}/\text{m}^3$ 24-hour mean. However, even these might not be safe. In 2013, a large survey published in The Lancet "found a 7% increase in mortality with each 5 micrograms per cubic metre increase in particulate matter with a diameter of 2.5 micrometres (PM2.5)."

First, you'll need a Raspberry Pi (any version) that's set up with the latest version of Raspbian, connected to your local network, and ideally with SSH enabled. If you're unsure how to do this, there's guidance on the Raspberry Pi website at raspberrypi.org/help.

The wiring for this project is just about the simplest we'll ever do: connect the SDS011 to the Raspberry Pi with the serial adapter, then plug the Raspberry Pi into a power source.

Before getting started on the code, we also need to set up a data repository. You can store your data wherever you like – on the SD card, or upload it to some cloud service. We've opted to upload it to Adafruit IO, an online service for storing data and



You can store your data wherever you like – on the SD card, or upload it to some cloud service. We've opted to upload it to Adafruit IO



making dashboards. You'll need a free account, which you can sign up to at io.adafruit.com – you'll need to know your Adafruit username and Adafruit IO key in order to run the code below. If you'd rather use a different service, you'll need to adjust the code to push your data there.

We'll use Python 3 for our code, and we need two modules – one to read the data from the SDS011 and one to push it to Adafruit IO. You can install this by entering the following commands in a terminal:

```
pip3 install pyserial adafruit-io
```

You'll now need to open a text editor and enter the following code:

```
import serial, time
from Adafruit_IO import Client
aio = Client('your-adafruit-username', 'your-adafruit-key')
ser = serial.Serial('/dev/ttyUSB0')
```

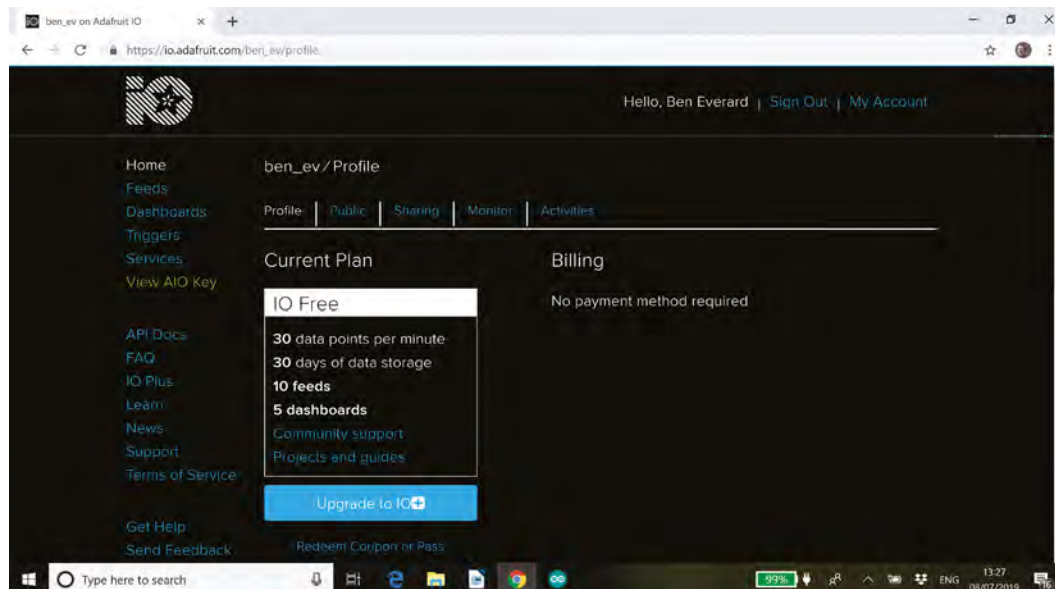

Right  The Adafruit IO web service lets you keep track of data without having to store it yourself

WHERE TO LOCATE YOUR SENSOR

Standard advice for locating your sensor is that it should be outside and four metres above ground level. That's good advice for general environmental monitoring; however, we're not necessarily interested in general environmental monitoring – we're interested in knowing what we're breathing in.

Locating your monitor near your workbench will give you an idea of what you're actually inhaling – useless for any environmental study, but useful if you spend a lot of time in there. We found, for example, that the glue gun produced huge amounts of PM2.5, and we'll be far more careful with ventilation when using this tool in the future.

```
while True:
    data = []
    for index in range(0,10):
        datum = ser.read()
        data.append(datum)

    pmtwofive = int.from_bytes(b''.join(data[2:4]),
byteorder='little') / 10
    aio.send('kingswoodtwofive', pmtwofive)
    pmten = int.from_bytes(b''.join(data[4:6]),
byteorder='little') / 10
    aio.send('kingswoodten', pmten)
    time.sleep(10)
```

This does a few things. First, it reads ten bytes of data over the serial port – exactly ten because that's the format that the SDS011 sends data in – and sticks these data points together to form a list of bytes that we call data.

We're interested in bytes 2 and 3 for PM2.5 and 4 and 5 for PM10. We convert these from bytes to integer numbers with the slightly confusing line:

```
pmtwofive = int.from_bytes(b''.join(data[2:4]),
byteorder='little') / 10
```

The `from_byte` command takes a string of bytes and converts them into an integer. However, we don't have a string of bytes, we have a list of two bytes, so we first need to convert this into a string. The `b''` creates an empty string of bytes. We then use the `join` method of this which takes a list and joins it together using this empty string as a separator. As the empty string contains nothing, this returns a byte string that just contains our two numbers. The `byte_order` flag is used to denote which way around the command should read the string. We divide the result by ten, because the SDS011 returns data in units of tens of grams per metre cubed and we want the result in that format.

`aio.send` is used to push data to Adafruit IO. The first command is the feed value you want the data to go to. We used `kingswoodtwofive` and `kingswoodten`, as the sensor is based in Kingswood. You might want to choose a more geographically relevant name. You can now run your sensor with:

ADAFRUIT IO

You can use any data platform you like. We chose Adafruit IO because it's easy to use, lets you share visualisations (in the form of dashboards) with others, and connects with IFTTT to perform actions based on values (ours tweets when the air pollution is above legal limits).

One thing to be aware of is that Adafruit IO only holds data for 30 days (on the free tier at least). If you want historical data, you'll need to sign up for the Plus option (which stores data for 60 days), or use an alternative storage method. You can use multiple data stores if you like.



```
python3 airquality.py
```

...assuming you called the Python file **airquality.py** and it's saved in the same directory the terminal's in.

At this point, everything should work and you can set about running your sensor, but as one final point, let's set it up to start automatically when you turn the Raspberry Pi on. Enter the command:

```
crontab -e
```

...and add this line to the file:

```
@reboot python3 /home/pi/airquality.py
```

With the code and electronic setup working, your sensor will need somewhere to live. If you want it outside, it'll need a waterproof case (but include some way for air to get in). We used a Tupperware box with a hole cut in the bottom mounted on the wall, with a USB cable carrying power out via a window. How you do it, though, is up to you.

Now let's democratise air quality data so we can make better decisions about the places we live. □

“ **Your sensor will need somewhere to live. If you want to mount it outside, it'll need a waterproof case (but include some way for air to get in)** ”

CHECKING ACCURACY

Now you've got your monitoring station up and running, how do you know that it's running properly? Perhaps there's an issue with the sensor, or perhaps there's a problem with the code. The easiest method of calibration is to test it against an accurate sensor, and most cities here in the UK have monitoring stations as part of Defra's Automatic Urban and Rural Monitoring Network. You can find your local station here: hsmag.cc/dfvwwz. Many other countries have equivalent public networks. Unless there is no other option, we would caution against using crowdsourced data for calibration, as these sensors aren't themselves calibrated.

With a USB battery pack, you can head to your local monitoring point and see if your monitor is getting similar results to the monitoring network.

Above ♦ You can access the TX and RX pins directly if you want to interface this sensor with something that doesn't have a USB port

2nd
Edition

FULLY UPDATED FOR RASPBERRY PI 4

THE OFFICIAL
Raspberry Pi
Beginner's Guide
How to use your new computer

The official Raspberry Pi Beginner's Guide

2nd Edition

by Gareth Halfacree

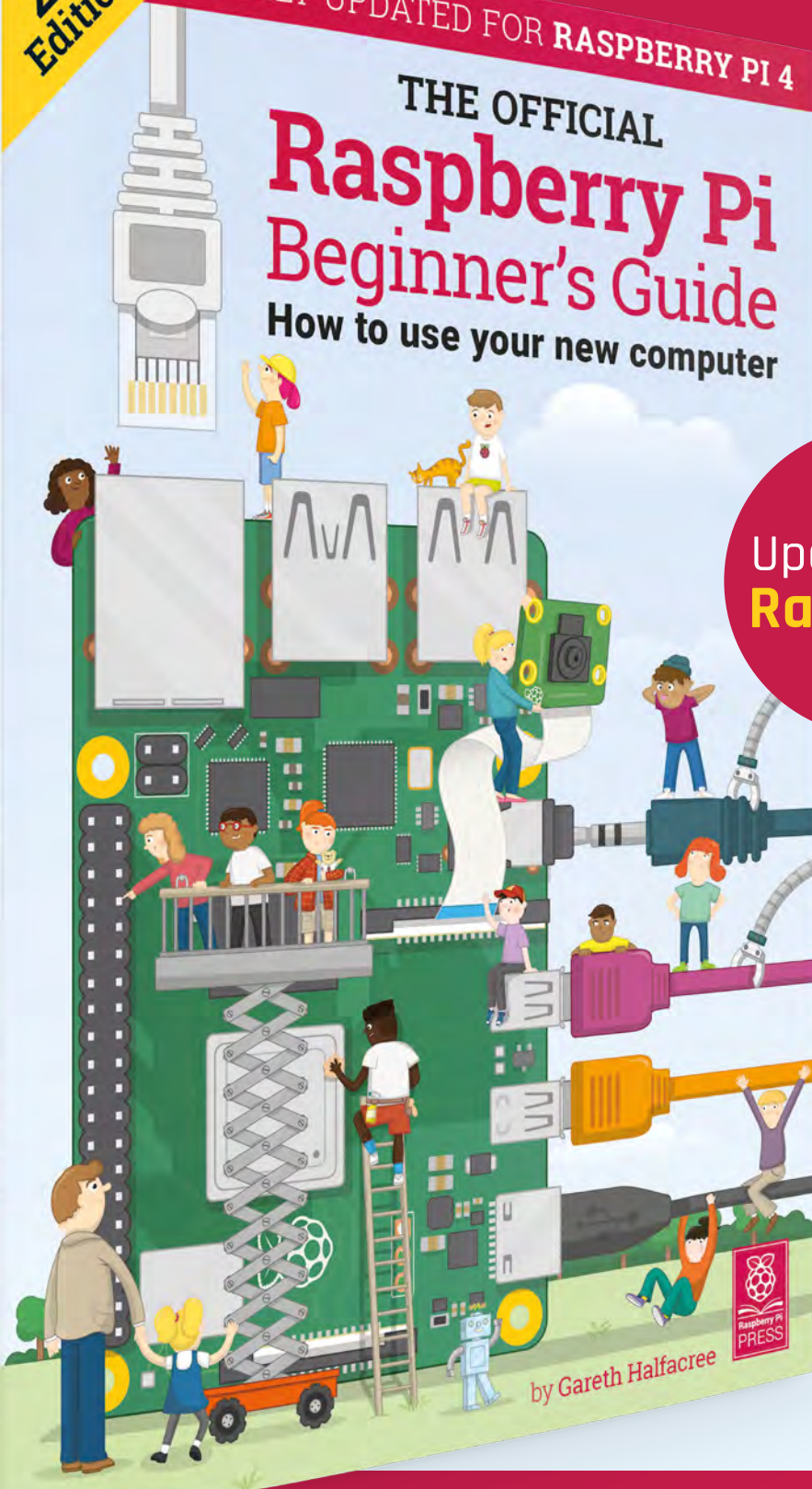

Fully
Updated for
**Raspberry
Pi 4**

by Gareth Halfacree



THE OFFICIAL Raspberry Pi Beginner's Guide

The only guide you need to
get started with Raspberry Pi

Inside:

- Learn how to set up your Raspberry Pi, install an operating system, and start using it
- Follow step-by-step guides to code your own animations and games, using both the Scratch and Python languages
- Create amazing projects by connecting electronic components to Raspberry Pi's GPIO pins

Plus much, much more!

£10 with **FREE** worldwide delivery

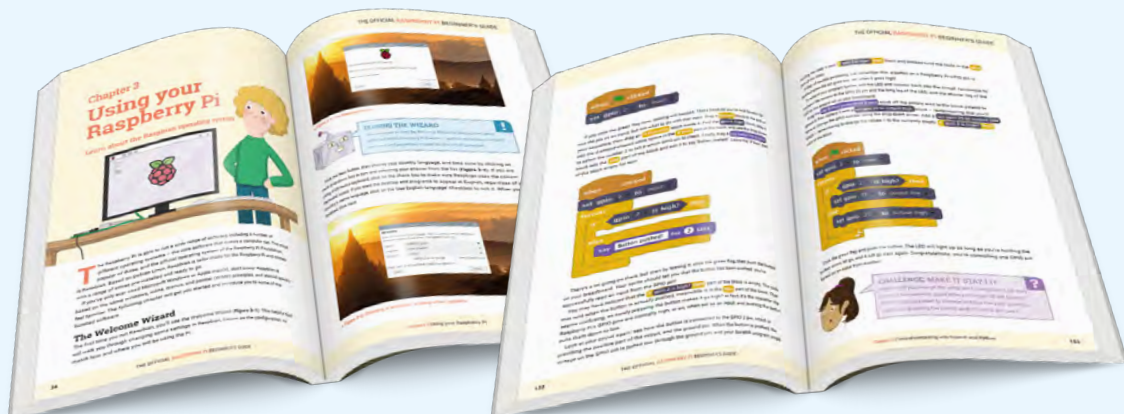

Buy online: magpi.cc/BGbook



Above ♦
Each number is made out of Tetris blocks that fall into place

WiFi Tetris clock

An internet-driven clock drawn using Tetris blocks!



Brian Lough

[@witnessmenow](#)

Brian is a maker from Ireland who primarily creates projects and libraries for the ESP8266 and ESP32 microcontrollers. He also designs and sells boards on his Tindie store. Check out his stuff on his YouTube channel and [blough.ie](#)

Tetris has been entertaining people ever since it was released in 1984. There have been many versions of the game, including the multiplayer battle royale-style Tetris 99 released just this year. It is a timeless classic that has spanned many generations of gamers.

Its iconic falling blocks are instantly recognisable to almost anyone, regardless of their interest in video games. But instead of using the blocks to clear lines, we are going to use them to tell time!

This project draws out the digits of a clock using the classic Tetris shapes on an LED matrix display.

Measuring in at roughly 19 × 9.5 cm, this is physically quite a large display and is also very bright, so the result is incredibly eye-catching.

Another twist with this project is, unlike traditional Arduino clock projects, it does not use an RTC module for keeping time – instead, the time for the clock is set from the internet. One big

advantage of this is that you only need to set your time zone and the clock will then automatically display the correct time; it will even adjust for daylight savings.

This is a surprisingly easy project to put together that should only take a couple of hours in total. So, armed with this guide, you should have no excuses to not make one!

THE LED MATRIX DISPLAY

The intended purpose for these displays is to chain them together to make up huge screens, as seen at concerts etc., but they can be controlled individually using a microcontroller. The displays come in a lot of different configurations, but most should work with this project.

When picking one of these displays, there are a couple of key pieces of information. The first thing is the pitch, which is the distance between the centre of each LED. This is marked on the listing of the displays by the number after the 'P'; for instance, P3 indicates that the display has a pitch of 3 mm. Displays with larger pitches will be physically bigger.

The second thing to note is the resolution of the display, which is how many LEDs are available to use. A display with a resolution of 64×32 means it

A POTENTIAL FASHION ACCESSORY?

In issue 16, Les Pounder showed how you could hack a 'Pixel Purse' to make use of the LED matrix it contained. The display in that toy uses the same HUB75 interface as the LED matrix used in this project, but it has a lower resolution (32×16).

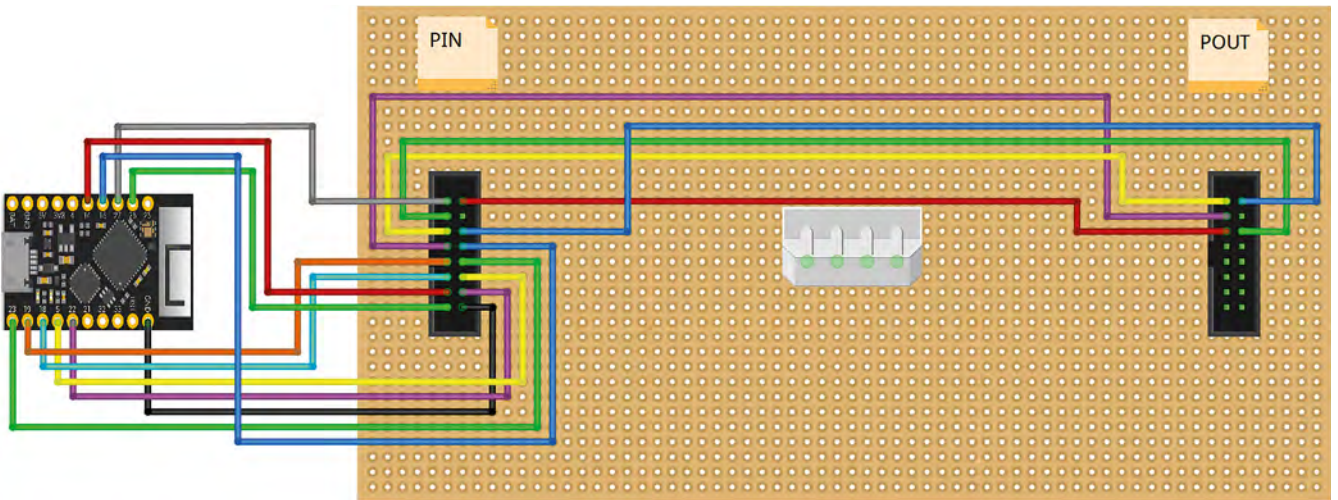

Above ♦ The wiring diagram for a TinyPICO. Details for other ESP32-based boards can be found at hsmag.cc/QXmJtz

Below ♦ The TinyPICO is an ESP32 development board that recently went through a successful crowdfunding campaign on Crowd Supply

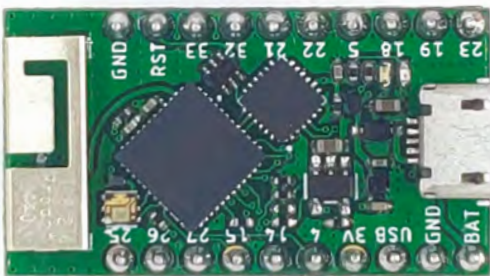

Below ♦ Our display gives us 64x32 LEDs to play with

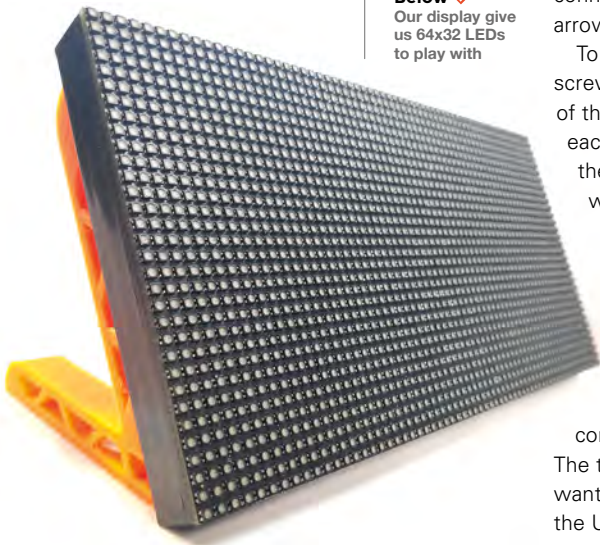

will have 64 LEDs across, and 32 LEDs down. This project is coded to work on 64x32 displays, but it could be adapted for other ones if needed.

These displays can be driven with lots of different microcontrollers. People commonly use them with Raspberry Pi boards, but for this project, we are going to use an ESP32. An ESP32 is an inexpensive, Arduino-compatible, microcontroller with built-in WiFi.

// The simplest way to power the ESP32 is to power it via a separate USB power supply //

When wiring the display up, pay special attention to the arrows that will be printed on the PCB of the display – the ESP32 needs to be wired to the connector that arrows are moving away from. These arrows can be seen in **Figure 1** overleaf.

To power the display, use a female DC jack to screw terminal adaptor, and insert one of the prongs of the power wire that comes with the display into each screw terminal, connecting the black wire to the screw terminal marked with a '-' and the red wire to the one marked with a '+'. Once you're happy with the connection, use insulating tape or heat-shrink to provide some extra strength to the connection.

The simplest way to power the ESP32 is to power it via a separate USB power supply, but it can be connected to the same power supply as the display by connecting to the '5V' or 'USB' pin of your ESP32. The thing to be careful about with this is you don't want to get into a situation where the power from the USB of your PC is powering the entire display, →

QUICK TIP

The ESP32 is the successor to the widely popular ESP8266. It is more powerful and has more GPIO pins.

YOU'LL NEED

- ♦ **P3 64x32 RGB LED matrix**
- Available on AliExpress, eBay, or Adafruit
- ♦ **TinyPICO - tinypico.com**, but any ESP32 board should work, e.g. HUZAZH32
- ♦ **5 V power supply**
- 4 A or larger should do the trick
- ♦ **20 cm female to female DuPont cables**
- ♦ **Female barrel jack to screw terminal adaptor**
- Depends on what head is on your power supply
- ♦ **3D-printed stands for LED matrix** - Or something to keep it upright!

TUTORIAL

Right

What your wiring should look like when you are ready to go

Below

Screw terminals make it easy to add a power connector

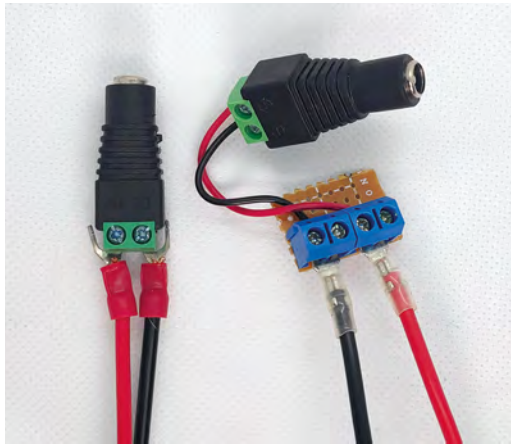
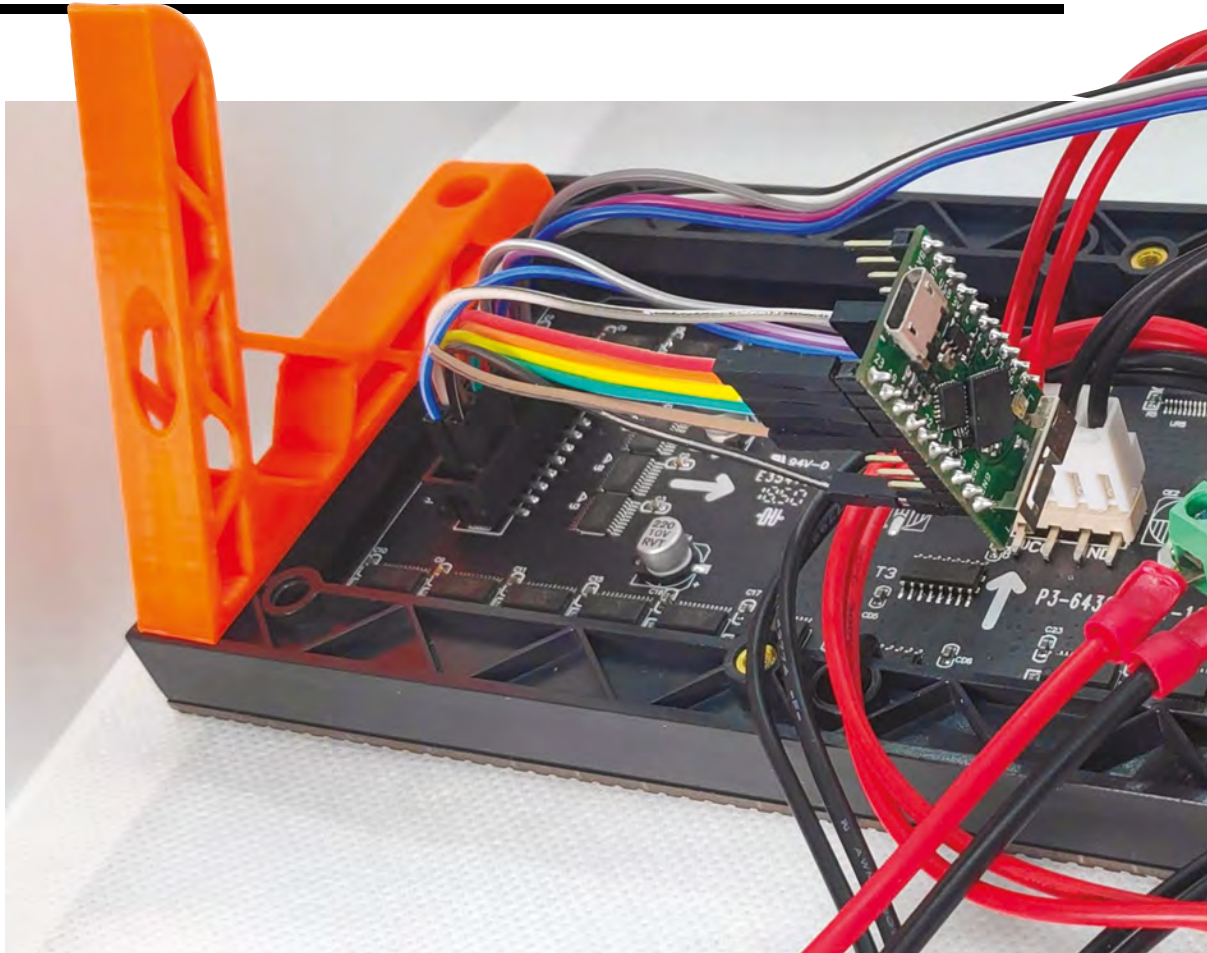

as the display will pull more current than your PC USB port is able to provide. The best way to prevent this from happening is to use a diode (Schottky 1N5817, for example). Put the negative side of the diode facing the microcontroller, so 5V from the power supply can go to the ESP32, but 5V from the ESP32 cannot go to the display.

The display is pretty unsteady standing up on its own, so it's highly advisable to create a stand for it. If you have access to a 3D printer, these stands designed for the P3 matrix work great – hsmag.cc/bGLDTh. You will need to use some 10 mm M3 screws to attach it to the display.

If you wanted to port this project to the purse display, you would only need to remove the text

QUICK TIP

If the ESP32 board you are using does not have the same pins used in the wiring diagrams, you should be able to swap any for other GPIO pins, but you'll need to reflect this in the code.

PROGRAMMING THE ESP32

If you are not already set up for programming an ESP32, you will need to do the following:

First, you will need to download the Arduino IDE from the Arduino website and install it – hsmag.cc/UHQfXs.

Next, you will need to set up the Arduino IDE to be used with an ESP32. Open the Arduino IDE, go to File > Preferences, and paste the following URL into the Additional Boards Manager URLs and click OK: dl.espressif.com/dl/package_esp32_index.json.

Back on the main screen of the Arduino IDE, navigate to Tools > Board > Boards Manager. When this screen opens, search for 'ESP32' and install it. Note that this may take a few minutes, depending on the speed of your internet connection.

After setting up a new board, it is recommended to try out a simple blink sketch before attempting anything more complicated. This can save a huge amount of headaches down the line!

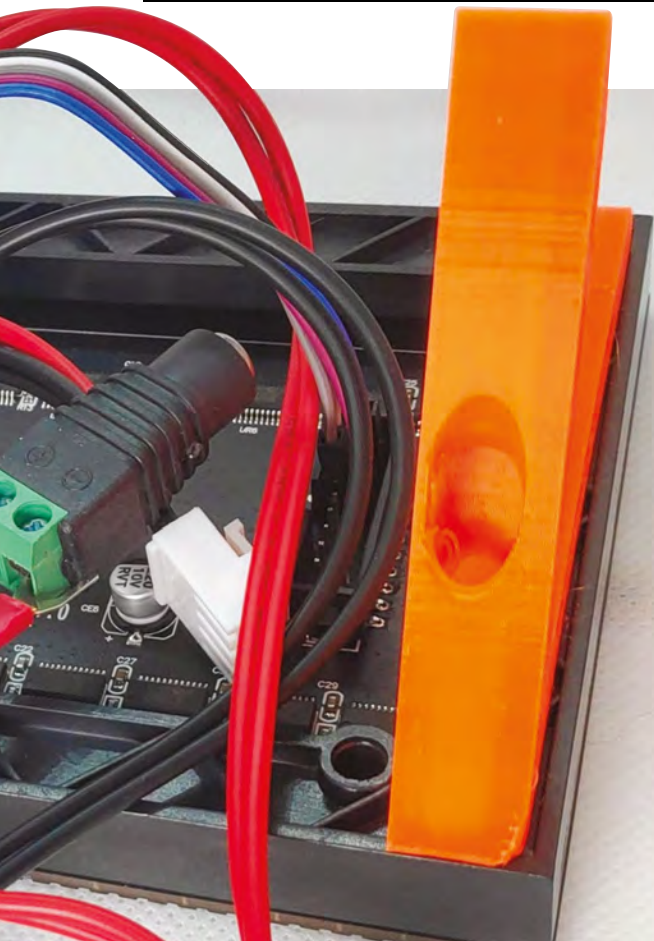

NOT JUST FOR LED MATRICES

The Tetris Animation library, used for this project, works with more than just these LED matrix displays. The library works with any displays that make use of the Adafruit GFX library.

Adafruit GFX provides a set of methods for drawing and for writing text that is abstracted from the hardware of the screen. It needs to be paired with a hardware-specific library that is able to communicate with the display.

Since the Tetris Animation library only uses methods contained in the Adafruit GFX library, it means that it can be used with any display that has a library that uses Adafruit GFX (and there are a lot of them!).

QUICK TIP

If the display doesn't look correct, or seems to be missing colours, double-check that your wiring is correct.

Figure 1 (top) ♦ Make sure to pay attention to the arrows on the board when you are wiring it up

Bottom ♦ A custom PCB that makes use of the ribbon cable that comes with the display to keep the wiring neater

scaling and make some minor positional adjustments to the text, and it would work fine.

SETTING UP THE CODE

The code for this project is available on GitHub. Point your web browser to hsmag.cc/rpULIs and click the Clone or Download button on the right-hand side of the page, and then Download Zip. Extract the zip file. Inside the extracted folder, open up the **ESP32** or **TinyPICO** folder, then the **EzTimeTetrisClockESP32** folder, and open the **EzTimeTetrisClockESP32.ino** file.

This sketch requires some additional Arduino libraries to be installed:

- Tetris Animation by Tobias Blum – handles the Tetris-style animating of the clock
- PxMatrix by 2Dom – for controlling the matrix display
- EzTime by ropg – used to get the time from the internet
- Adafruit GFX by Adafruit – the base library that PxMatrix is built upon.

Details of which versions of the libraries are needed, and where to get them, are contained up near the top of the Arduino sketch. After installing these libraries, you should click the →

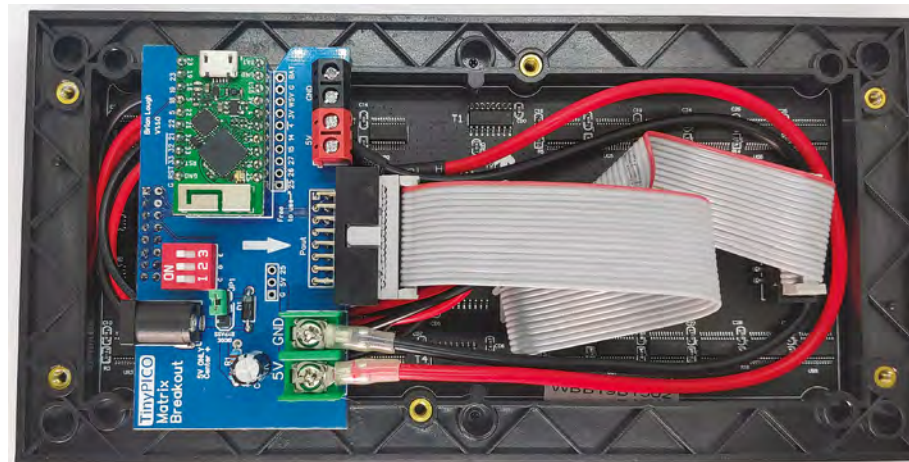
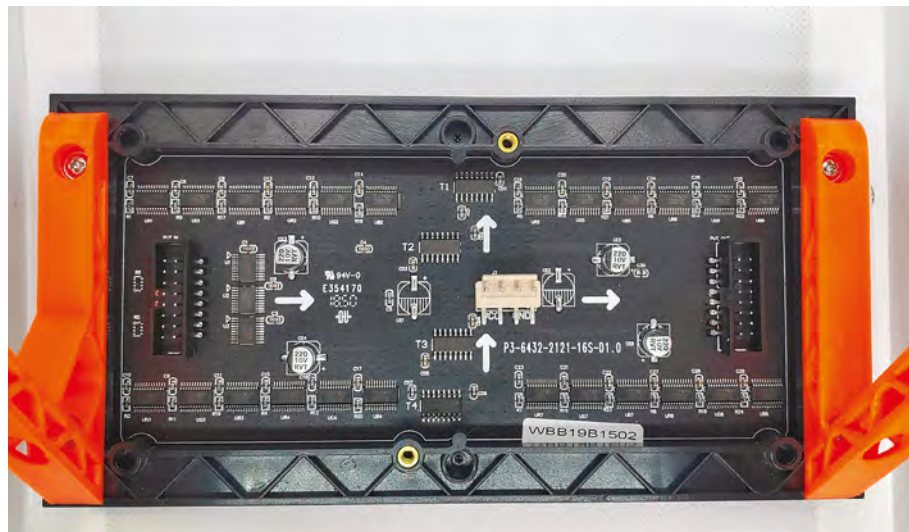

TUTORIAL



Above  Numbers falling into place

Right  You could build your own version of this animated timepiece

‘verify’ button (shaped like a tick) on the EzTimeTetrisClockESP32 sketch to make sure that everything compiles fine.

You will need to make a couple of changes to the sketch so that the clock functions correctly for you. Inside the ‘Stuff to configure section’, set your SSID and password for your WiFi.

Just below that, set your time zone in the format ‘Europe/Dublin’; there’s a comment in the sketch with a link to a full list of possible time zones.

And finally, if you are using a different ESP32 board than the TinyPICO, you will need to change the wiring. Search for ‘Generic’ in the sketch and uncomment the two lines that you find, and comment out the adjacent lines that contain a ‘TinyPICO’ comment.

When you’ve finished configuring, upload the code to your ESP32, and you should see it animating in all its blocky glory!



TINKERING WITH THE SETTINGS

There are several adjustments you can make to the clock to so it works exactly as you would like it.

If you would prefer a clock with a 24-hour format, set `twelveHourFormat` to false.

The `forceRefresh` option controls how many of the digits get drawn every minute. If it is set to true, the entire clock will be cleared and it will draw all the digits again. If set to false, it will clear only the digits it needs to; for instance, if the time was currently ‘10:29’ and it needed to update, only the ‘2’ and the ‘9’ would be replaced – the ‘10’ would remain on screen.

And finally, you can adjust the speed at which the Tetris blocks fall by changing the value that triggers the `animationTimer`. By default in the sketch, it’s set to 100000, which is 100,000 microseconds, or 0.1 of a second. Reducing this number will make the blocks fall faster. Changing the value to 50000 will result in the animation being twice as fast.

Once you’ve made those changes, upload the code again and you’ll have the clock working just the way you like. All that’s left to do is to while away the time watching the blocks fall. 

THE POWER OF OPEN SOURCE

The Tetris Animation library is derived from a project created by Tobias Blum (toblum on GitHub), who created a clock using the Tetris animation, but it was hard-coded to work with a 32x16 display, and the code for getting the time and the animation code were intertwined. His sketch was open source and after discussing it with him, this author extracted just the animation part of the sketch into a standalone Arduino library so it could be used to draw any numbers, not just a clock. I also took the opportunity to change the library to use generic references to the Adafruit GFX library and add some additional features, such as the ability to scale the digits

Another developer, Mike Swan (n00dles101 on GitHub) then further improved the library by adding support for text characters. Each of the characters had to be manually coded to work, so Tobias and Mike did some amazing work on this!

Wireframe

Join us as we lift the lid
on video games



Visit wfmag.cc to learn more

Taking your rotary tool to the next level

Tricks of the trade and some must-have accessories to up your Dremel game



Gareth Branwyn

[@garethb2](#)

Gareth has been a lifelong practitioner (and chronicler) of DIY tech, media, and culture. He is the author of ten books, including *Tips and Tales from the Workshop*, and is a former editor for *Boing Boing*, *Wired*, and *Make*.

Being able to accept such a wide variety of bits in their jaws, rotary tools (often called by the common brand-name, Dremel) are the go-to tool for all sorts of small-scale cutting, stripping and sanding, engraving, polishing, and many other tasks. You may already have one. What follows are some ideas for getting more out of your tool and using it in new ways.

What type of rotary tool you need depends a lot on what sorts of jobs it's going to do. If you need the tool in many different locations, a cordless model makes the most sense. For small-scale, bench-based work, like crafting, modelling, or jewellery, you'll want a corded version and may want to consider a flexi-shaft attachment. Great for precision work, a flexi-shaft allows you to grasp a small pen-like extension that holds the bits.

Rotary tools spin at extremely high speeds, spinning anywhere from 500 revolutions per minute to 35,000 rpm. Getting a variable speed tool will allow you to adjust the motor to achieve the right speed and torque for your job. Cheaper tools often have one or two speeds. Variable speed models are recommended. But don't be afraid to buy cheap rotary tools for light use. You can get a cheap tool for \$15, and it will serve you well for periodic, low-torque demands, like crafting or modelling.

ACCESSORIES TO CONSIDER

Besides the dizzying array of bits and other chuckable tools, there are some larger accessories that can greatly expand the versatility of your tool.

Dremel Multi Chuck This inexpensive, universal chuck is a must-have for anyone but the most casual multi-tool user. This greatly expands what bits your tool can hold.



Rotary tool multi-vice If you need to hold small objects while working on them, consider a Dremel Multi-Vice. Unlike a conventional bench vice, it is ball-jointed, so you can angle the vice as needed. It also comes with an accessory for holding your tool so that you can turn it into a stationary grinder/sander/cutter.

Drill-press A stand for your rotary tool is a great way to create a cheap desktop drill-press for precise small-scale work.

Router attachment Turn your rotary tool into a router with this simple attachment.

Flexi-shaft You can turn most rotary tools into a flexible shaft rotary tool with a Dremel Flexi-Shaft attachment. Great for precision work, like fine carving and engraving.

EZ Lock system The Dremel EZ Lock system allows you to do quick changes of compatible cut-off wheels,

Above The Dremel vice lets you hold objects in almost any orientation

far more easily than wasting time with that slotted screw on the conventional shank.

TIPS FOR WORKING YOUR TOOL

- Rotary tools are an eye accident waiting to happen. ALWAYS wear eye protection!
- Let the tool do the work. Use light pressure. Be patient. Overheating the bit weakens it and over-stresses the motor.
- Rule of thumb: Speed up for smaller bits, slow down for bigger drums and wheels.
- When sanding wood, move the tool in the direction of the spin.
- When cutting metal, move the tool against the direction of the spin.
- Try a little beeswax on your bit. It lubes the drill and dissipates heat.
- Talcum powder can be used to get sanding drums on/off easier.

MAKING YOUR OWN BUFFS, DRUMS, AND WHEELS

It's easier than you might think to make your own rotary bits. To make abrasive buffs, all you have to do is cut a piece of 3M stripping pad, or similar abrasive fibre pad, to your desired diameter (bigger than commercial buffs, if you like). To create a shank, cut the head off of a #6-32 x 1-1/4" machine screw. Poke a hole in the centre of the buff and attach it with two bolts above and two bolts below. For more information, take a look at hsmag.cc/geFmDz.



Above ♦ Keith's Test Garage has a great idea for making a rotary bit holder. Check out their video at youtu.be/WPQ_b27jyM

To create sanding drums, all you have to do is glue strips of the sandpaper grit of your choice onto the wooden dowel rod. You can use different diameter dowel for different size drums. Make sure to clamp the sandpaper down well to the dowel to get good adhesion. When dry, cut the dowel to short lengths to create your drums. You can see a video on how to do this here: youtu.be/G1DOT3VjTsw.

You can even make your own sanding discs and cut-off wheels using flattened metal bottle caps. Check out this video: youtu.be/NcAhrnRo70.

If you're making your own accessories, pay extra attention to safety when running your tool, and make sure that no one is going to get hurt if the attachment disintegrates at full speed.

ADDITIONAL USES FOR A ROTARY TOOL

Blade and tool sharpening There are all sorts of grinding bits for various types of blade, sawtooth, and tool sharpening. Search YouTube for sharpening instructions for your specific blade/tool type.

Cutting through-holes in PCBs With a set of tiny carbide dental bits, you can drill holes in printed circuit boards.

Cutting holes in glass Submerge the glass in water, use a diamond bit, a low rpm setting, take your time, and you can easily drill holes in glass.

Cutting/carving rocks You can use stone and diamond-coated bits to carve through rock like a hot knife through butter.

Re-cutting stripped screw heads If the head of a screw is stripped, use a cut-off wheel to cut a new slotted head.

Engraving You can engrave metal, wood, glass, and other materials using diamond-coated bits. □

Thanks to
Bob Knetzger, Dug North, Michael Colombo, Kris DeGraeve, and Andrew Lewis for their suggestions.

YOU'LL NEED

- ♦ A Dremel or other rotary tool
- ♦ A collection of rotary tool bits, wheels, sanding drums, and blades
- Optional recommended
- ♦ Rotary tool vice
- ♦ Multi chuck
- ♦ Flexi-shaft attachment
- ♦ Router collar attachment
- ♦ EZ Lock system
- For making sanding drums
- ♦ Wooden dowel of different dimensions
- ♦ Sandpaper of various desired grit
- ♦ White glue
- For making abrasive buffs
- ♦ 3M stripping pads
- ♦ #6-32 x 1-1/4" machine screws and matching nuts

BRUSHING UP ON A BROKEN MOTOR

Sadly, many rotary tool owners don't know that when a tool becomes sluggish or stops working, it is likely only worn motor brushes. These are easily and cheaply replaced via two screws, usually found on the sides of the tool. The carbon brushes can be bought for under \$10 and literally take seconds to replace.



Fusion 360

Design moving mechanisms on your computer

It's all about having the right moves



Andy Clark

workshopshed

For the last ten years, Andy has been making and repairing in a shed at the bottom of the garden. You can see more of his exploits at workshopshed.com

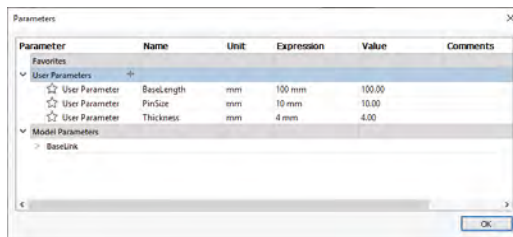

Left Parameters let you customise a design

setting the diameter, rather than typing a number, type 'PinSize' and it will read in your parameter and set the size to 10. Next, add a second circle with the same 'PinSize' as the diameter. The exact position is not important, but place it on the same horizontal line as the first. Now add a sketch dimension between the centres of the two circles. Set this dimension to 'BaseLength' and the circles will separate accordingly.

Join up the outside of these two circles with lines to form a slot – you should see that the tangent constraint is automatically picked up. If not, add in these constraints. Trim the circles to remove the curved lines that are on the inside of the slot.

Add a third circle of the same size, and use the dimension to position it 'PinSize * 1.5' millimetres to the left of the slot.

Below The two holes need to be separated by the length of the base



in issue 20, we looked at how Fusion 360 is a parametric modelling system. This means that, by using parameters with components and joints, we can create models that can be used to experiment with motion.

By adding constraints and limits, we can have more control over our models. Contact sets allow us to use the parts themselves to constrain the motion.

We have already seen the revolute and slider joints. The scissor lift and G-clamp show how these are combined in two different ways to form the pin-slot and cylindrical joints.

SCISSOR LIFT

The scissor lift is a great example of the pin-slot joint. We can model this system using parameters so that it can be scaled to any size you want. Constraints ensure that it does not change shape when scaled.

We start by adding three parameters: BaseLength = 100mm, PinSize = 10, and Thickness = 4.

Start a new component, activate it, and add a sketch. The first thing to draw is a circle. When

YOU'LL NEED

- A computer capable of running Fusion 360
- An internet connection

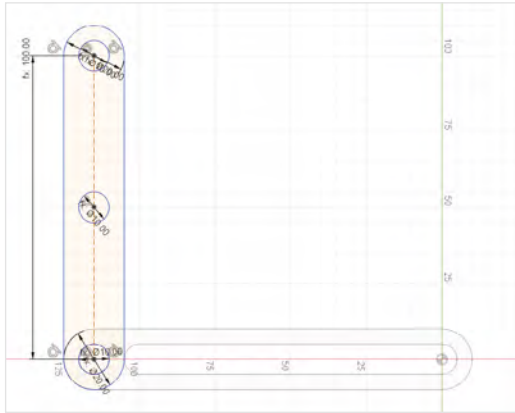

Horizontal/Vertical Locks to one of the axes		Horizontal/Vertical		Coincident Glues two points together
Tangent Line is tangential to a circle		Tangent		Equal Lines the same length
Parallel Lines are equidistant for their length		Parallel		Perpendicular Lines at right angle to the other
Fix/UnFix Point or line does not move as you drag others		Fix/UnFix		MidPoint Join at the midpoint
Concentric Circles have the same centre point		Concentric		Collinear Along the same line
Symmetry Symmetrical in a line or plane		Symmetry		Curvature Two curves have a smooth transition where they join

To form the outside of the link, create a circle centred on the same point as this circle, and make the size equal to 'PinSize * 2.0', and another of the same size at the right end of the slot. Again, join up these two circles and ensure they are constrained to the circles with tangent constraints. Trim the circles

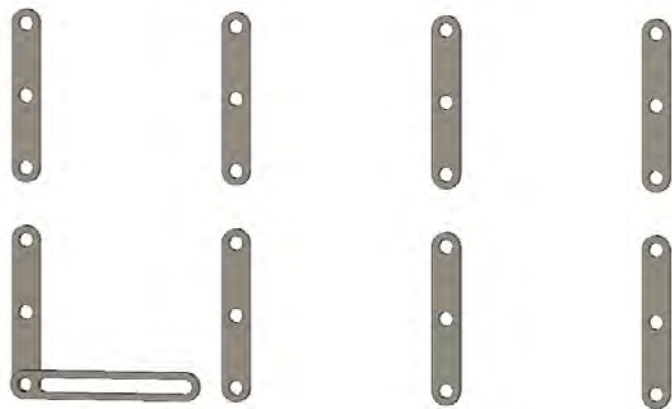

By adding constraints and limits, we can have more control over our models

to form the outer of the link. Finish the sketch and extrude to complete the first component.

To assist with locating the components, you can rename this one to be 'BaseLink'.

Start a new component, activate it, and add a sketch in the same plane as last time. Start with a circle centred on the circle from the base link. Again, the size is 'PinSize'.

Create a second circle the same size vertically above. Add a dimension, and set to 'BaseLength'.

Draw a line between the centres of the circles and set this as a construction line. Turn off construction and create the third circle on the centre point of this line.

To create the outside of the link, use the same technique as the base link with two circles and two lines with tangential constraints. Trim the excess.

Extrude the sketch, this time entering 'Thickness' for the distance.

Use the rectangular pattern to create seven more links. Connect the base link and original link →

QUICK TIP

Construction lines are not shown in the final sketch, but can still be part of a constraint.

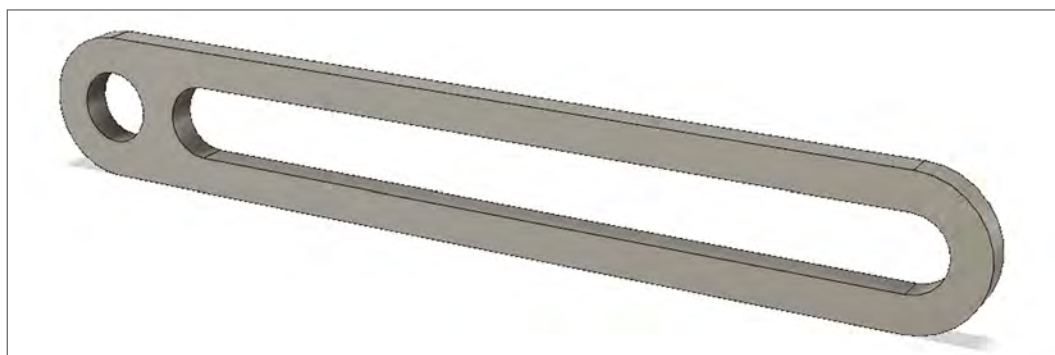

Top Left CAD can give you different ways of viewing the same object

Above Starting to assemble our parts

Left Our base bar ready for assembly

TUTORIAL

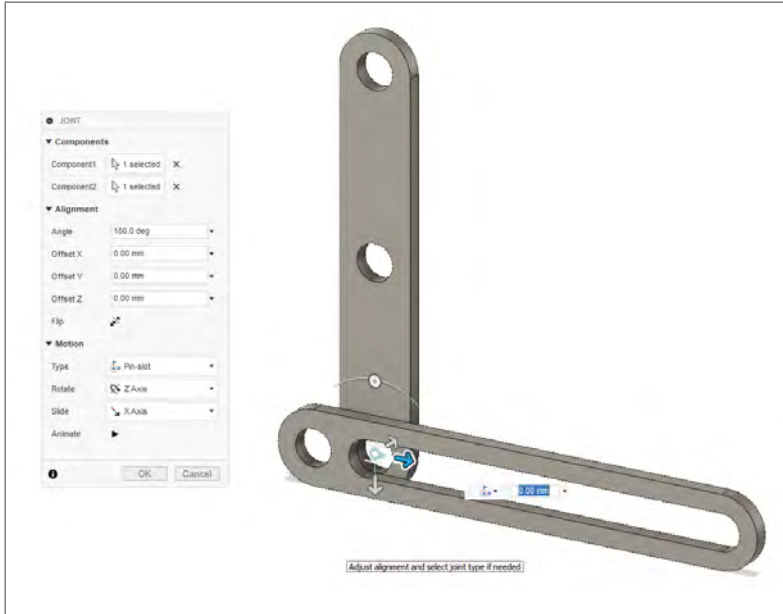

Above Joining the link to the base

Above Right The scissor list, modelled and in action

together using a revolute joint. Add a Z Offset of '2 * Thickness' to leave a gap between these components. This leaves space for the sliding link.

Ground the base link so that it doesn't move as we assemble the links. Use revolute joints to connect the links together. Take care to alternate front and back faces so that the links don't clash. It will help if you rotate the links by 90 degrees as you go. Once you've assembled all of the links, go back

The G-clamp will be driven from three parameters: the length, depth, and thickness. These can default to 100mm, 40mm, and 10mm respectively.

Start a new model with a new component, and add a sketch. Draw a vertical line and set the length to be 'Length', the parameter defined earlier. Draw a horizontal line and set the length to 'Depth + Thickness'. Draw vertically up, 'Thickness', then back to the left, 'Depth'. Draw up 'Length - (2 * Thickness)', right 'Depth', up 'Thickness', and finally join back to the top. Extrude the sketch by 'Thickness' to create a 3D shape.

Select the top surface and add a hole. Add references so that the hole is 'Thickness / 2' distance from the end and side. Set the tap type to 'Tapped', and the hole depth to 'Thickness'. Pick the hole size from the drop-down list; we used 5mm.

Create and activate a new component for the screw part of the clamp. Create a cylinder '1.5 * Thickness' in diameter and 'Thickness' in height. Add a smaller cylinder on top of this one with a diameter of 5mm, and height of 'Length - Thickness'. Add a small sphere to the end of the cylinder.

Select the thinner cylinder and add a screw thread. This should default to 5mm, and needs to match the one you created earlier.

The last component is the jaw; this starts as a 5mm circle in a sketch. Finish the sketch and extrude a distance of 'Thickness' with a taper angle of 20 degrees. Turn off this truncated code and

|| The G- or C-Clamp is a popular type of clamp in the workshop. It works by having a screw thread to push a clamping face to a fixed face **||**

and join the lower right link to the slot using the pin-slot link. Link the front of the link to the back left-hand end of the slot.

Add joint limits, setting the minimum to 'PinSize' and the maximum to 'BaseLength - (2 * PinSize)'.

Test your model using the drive joints or motion study tools. Test your constraints and parameters by changing the three model parameters.

QUICK TIP

Use the joint rather than as-built joint to allow for adjustments.

G-CLAMP

The G- or C-Clamp is a popular type of clamp in the workshop. It works by having a screw thread to push a clamping face to a fixed face. The friction on the screw stops the material pushing the clamp open.

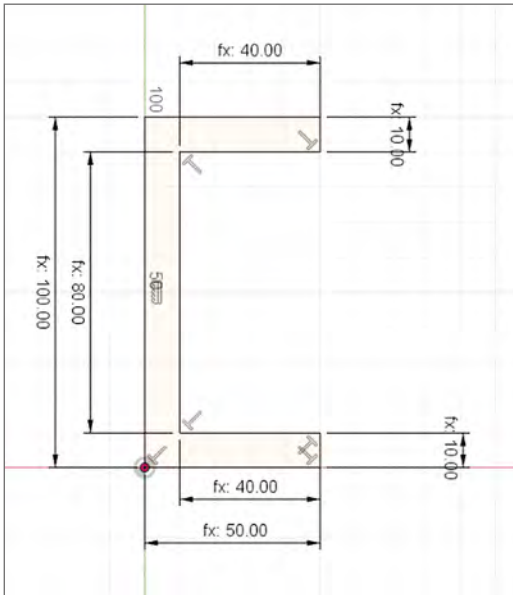

sketch a 5 mm sphere onto the top, cutting out a hole.

We can now assemble components. Add a new joint, select the hole in the clamp body and the end of the screw thread closest to the handle. Specify the cylinder joint. It will help for positioning the jaw if you add an offset so that the clamp is part open.

Add another joint. This time, select the ball on the end of the screw, and the ball on the inside of the jaw. Specify a ball joint.

Below Ready for some virtual clamping

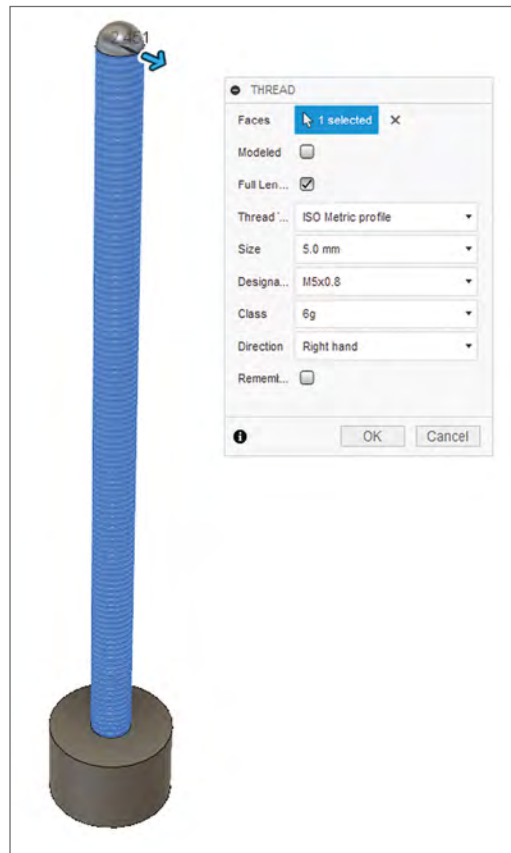

Far Left The basic clamp outline

Left Creating a screw thread in Fusion 360

Add joint limits to constrain the motion of the jaw. We found 120 degrees gave good motion for pitch and yaw. You may find you need to offset these limits based on the initial position.

Add a motion link to control the screw's motion. Tick the box 'Link with same joint'. Set the parameters so that the slider moves 0.8 mm for each 360-degree rotation.

To control the limits of the clamp, we can use a contact set – this stops one component passing through another. Enable contact sets, and add a new set consisting of the body and jaw. Now, drive the joint and you will see that it stops at the point the jaw meets the body.

WHAT NEXT?

Add a cross hole in the G-Clamp handle to add a tommy bar, which can be moved with another cylindrical joint.

Create a figure using parameters to allow it to scale, and ball joints so it can be posed.

The scissor jack design could be used as a basis for an adjustable lamp or mirror.

Why not combine these two models and have a screw-driven platform lift? Add a second slotted link at the top to allow a flat platform to be mounted.

QUICK TIP

Use the modelled style for threads if you are 3D-printing the component, and unmodelled if you are using a tap to create this.



The UK's BRAND NEW FILM MAGAZINE

TRY
**THREE ISSUES
FOR £9.99**
with the code 'RASPBERRY'

THE LATEST RELEASES REVIEWED

FILM STORIES

A NEW FILM MAGAZINE, FROM THE CREATOR OF DEN OF GEEK

JACK & SARAH REVISITING AN OVERLOOKED 90S BRITISH HIT

CONFESSIONS OF A MOVIE PR REP

UNDERRATED MOVIE APOCALYPSES

PLUS ANNA SMITH, DEBBIE MOON, HOPE DICKSON LEACH, ROMESH RANGANATHAN, SIMON BREW

THE LATEST RELEASES REVIEWED

FILM STORIES

A NEW FILM MAGAZINE, FROM THE CREATOR OF DEN OF GEEK

EAST IS EAST, WILD WEST & REPRESENTATION

CONFESSIONS OF A CINEMA MANAGER

THE INCREDIBLE, OVERLOOKED BOX OFFICE RUN OF BETTE MIDLER

AUTISM IN THE MOVIES

FEATURING ROMESH RANGANATHAN, DEBBIE MOON, HOPE DICKSON LEACH, ANNA SMITH

ISSUE 3

FILM STORIES

HAS CINEMA GOT ITS FUNNYBONE BACK?

ILLNESS: ITS IMPACT ON HOW WE FEEL ABOUT FILMS

FIGHTING TALK

STEPHEN MERCHANT

REMI

21/1/17

WHY ON 12A CERS BLAST THE P

REVISIT UNDERRATED 90S

webscribe.co.uk/magazine/filmstories

FIELD TEST

HACK | MAKE | BUILD | CREATE

Hacker gear poked, prodded, taken apart, and investigated

PG
114

DIRECT FROM SHENZHEN: MICROWAVE KILN

Melt glass in the comfort
of your own home



PG
122

CAN I HACK THE FORCE?

A Star Wars-themed NFC
reader goes under the knife



PG
116

BEST OF BREED

The finest unusual Raspberry Pi HATs



REVIEWS

124 **Arduino Nano**
Tiny microcontrollers



126 **Nutube Pedal**
A new old-fashioned valve

128 **CircuitPython 4.1.0**
A need for speed

129 **The Art of Fermentation**
Brewing up flavour

DIRECT FROM
SHENZHEN

Microwave kiln

Create baubles in your kitchen

By Ben Everard

 @ben_everard

Working with glass usually requires thousands of pounds worth of equipment to carefully heat and cool the material. However,

what if you could bypass all this and just pop it in a microwave?

It's not quite that simple, because glass itself doesn't absorb the frequency of microwaves used to cook food, but that's where the microwave 'kiln' comes in. This device is basically a box made out of

high-temperature resistant insulator, with a lining of a material that absorbs the microwaves and converts them into heat. There's a small central section where you can put the glass you want to heat, then the lid goes on, and the whole lot goes in the microwave.

We bought a 12 cm kiln from July Tool's Store on AliExpress for £15.92, including shipping to the UK. We also got 50 sheets of kiln paper (£5.10), which is needed to stop the glass from sticking to the bottom of the kiln when it's melted.

12 cm is the outer diameter; there's actually only 7.5 cm of space to work with, and as you don't want your object too close to the edge, there's about a 6 cm diameter of workable space, but as the heat isn't evenly distributed, you'll get better results if you stick to 3–4 cm diameter objects.

Our biggest concern was whether the kiln would get up to temperature for melting glass, and it managed this in our 900W microwave. We measured the temperature at 690 °C, but we should note that this is at the absolute top end of our IR thermometer, and it was struggling to get a temperature – this was the temperature after we'd taken the glass out of the microwave, removed the kiln lid, got the thermometer into action, and lined up for the test. Basically, we're saying that it gets quite a bit hotter than this. While we can't give temperature ranges for it (and they will vary by microwave), in our experience, the kiln is hot enough to get the glass up to a temperature where basic working is possible, and separate pieces will melt and fully combine together.

When it comes to glass-work, getting up to temperature is only half the problem. Cooling the glass down slowly enough to prevent it cracking is also a challenge. However, our insulated box works for this as well. Once you've heated your glass up and fused it, the sealed box will slowly cool over about an hour.

Below ♦
A cooled piece made from bits of broken wine bottles melted together



For small pieces of work, we found that this was slow enough not to cause cracks as it cooled.

WAYS OF WORKING

There are several different ways you can work glass in a small kiln such as this. You can place the glass on top of a object and let the glass soften and take shape around this former, or you can place two bits of differently coloured glass together and fuse them to a new piece. You can even heat the glass up and manipulate it with a metal 'rake' to create swirls and other effects. We managed all of these to a greater or lesser extent.

Lots of different types of glass can work with a kiln such as this. We had some success using glass from old bottles – in general, we found that the glass was a little thin and the curves made it hard to stack, but thicker bottles, such as those used to store fizzy wine, worked better. The colours in bottle glass are usually quite muted. You can get much more highly coloured glass that's designed specifically for crafters.

We don't have space here to get into the full



Left ◊
Cooling glass, still glowing orange from the heat

Bottom ◻
By placing shapes under the glass, you can leave impressions in the finished glass-work

“ When it comes to glass-work, getting up to temperature is only half the problem

”

you fully understand the challenges beforehand.

While we had great fun testing this out, the results were mediocre. Without the ability to control the temperature of the kiln, there was a lot of trial and error, though ultimately, we were able to get it to about the right temperature. A bigger problem was that the heat wasn't evenly distributed, so the middle of our work got hotter than the outside, which led to some uneven melting. Ultimately, you can create fused glass with this, though it is a bit of a slow process to learn how to get good-looking fused glass. Over time, we're confident we could have learned better ways to work around the limitations, but these limitations are still going to be there. In short, this microwave kiln is a fun tool for exploring simple glass-work, but it's very limited. For the price, it's a great investment if you want to have a go at the basics – and if you're persistent, you'll probably be able to create some good-looking glass-work. ◻

DIRECT FROM SHENZHEN

An eclectic mix of useful kits for your Raspberry Pi

BEST OF BREED

ONLY THE BEST

An eclectic mix of useful kits for your Raspberry Pi

The wonderful world of Raspberry Pi accessories

By Marc de Vinck

 @devinck

In this month's Best of Breed, we're going to take a look at some of the products that don't fit into a standard theme or genre. They are more of the unusual products and HATs, like the three-eyed LED buzzer board, that many of you may never have seen before, but might find useful. It's an eclectic mix of products, ranging from simple LED HATs to power supply boards, and even cluster computing kits.

As each day goes by, we find more and more of these interesting, and sometimes weird, accessories for Raspberry Pi. And now, with the additional horsepower of the new Raspberry Pi 4, we would assume we are going to start to see even more fascinating applications and accessories. We hope you like these products as much as we do, and we'll keep our eye out for other unique Raspberry Pi HATs for future Best of Breed articles.

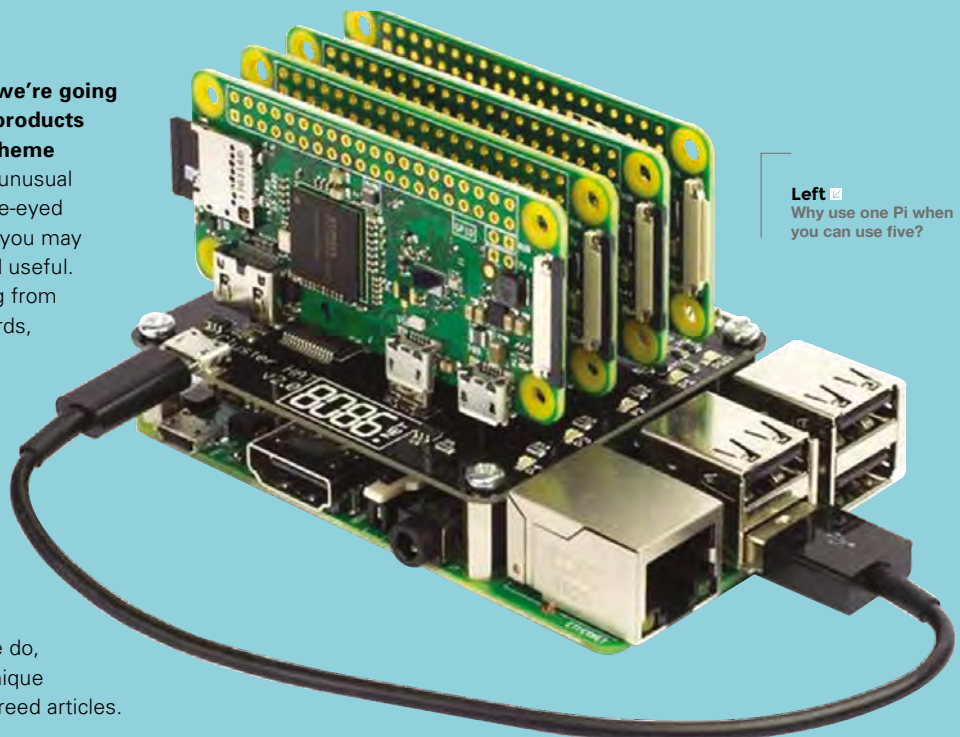

Left 
Why use one Pi when you can use five?

PiGlow vs Fish Dish Raspberry Pi LED Buzzer Board

Our go-to boards for a wide range of projects

PIGLOW ◆ \$13 | shop.pimoroni.com

FISH DISH ◆ \$5 | uk.pi-supply.com

The PiGlow is described as a spiral nebula of 18 individually controllable, and full-colour, LEDs for your Raspberry Pi. It sounds like a fun little board for creating a light show, and it is,

but it's also surprisingly useful for a lot of other projects. LEDs are the go-to component for notifications, but why should your project just have one boring LED? Now you can have multiple notifications, animations, and more through some fairly simple programming.

Pimoroni has included a Python library allowing you to easily create a multitude of different animated displays, and since it's compatible with any 40-pin Raspberry Pi, you can easily adapt your software to control the physical LEDs of this board. The board comes fully assembled and uses surface-mount LEDs and components, so it will fit inside Pimoroni's PiBow case and others. □



Above ▶
Strange and wonderful is a good description of this kit

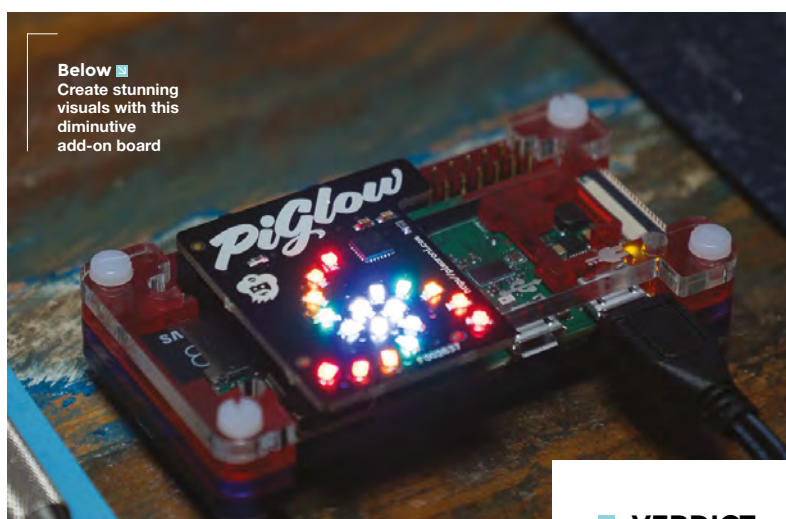

At first glance, this little board is strange. And after taking a second look, it's even stranger.

However, after thinking about what the Fish Dish Raspberry Pi LED Buzzer Board is, and how you might use it, we fell in love. It's a simple kit, featuring three LEDs, a few resistors, a button, and piezo buzzer. You don't need any fancy code to use it, and it's surprisingly useful.

Lots of Raspberry Pi users come from the software side of things, and that's where I think this board shines. It's a kit, and it's not intimidating. At only \$5, it's also affordable. I can see this kit being used to learn how to solder, then follow up with learning how to control the physical world via code. We like the idea that it is so basic, no fancy RGB LEDs, just simple and highly useful components on a quirky PCB in the shape of a three-eyed fish. □

VERDICT

PiGlow

An affordable accessory to start Raspberry Pi ventures.

9/10

Fish Dish Raspberry Pi LED Buzzer Board

Learn to solder, then learn to program with this unusual board.

9/10

An eclectic mix of useful kits for your Raspberry Pi

BEST OF BREED

Rainbow HAT

RAINBOW HAT ◆ \$30 | shop.pimoroni.com



The Rainbow HAT from Pimoroni is another product that packs a lot more than you think into a typical HAT form factor. With this board you can build a weather station, clock, timer, mood light, or just about anything you can imagine. OK, maybe not anything, but a lot of things since it features seven RGB LEDs, four seven-segment displays, three capacitive touch sensors, three LEDs, a temperature and pressure sensor, piezo buzzer, and breakout pins for adding more sensors.

This HAT is compatible with any 40-pin Raspberry Pi, and there is a downloadable Python library to get you up and running. Boards like these allow you to quickly test an idea since you don't have to wire anything up. Just plug it in and get coding. □

Left ◆ Pimoroni describes this HAT as a "buffet of sensors", and we agree

VERDICT
A very useful HAT for you.

10/₁₀

Adafruit Perma-Proto HAT for Pi Mini Kit – with EEPROM

ADAFRUIT ◆ \$7.50 | adafruit.com

Right ◆ Making something? Buy this!

VERDICT

A great prototyping HAT.

10/₁₀

There are a few prototyping HATs out there for Raspberry Pi, but only this one benefits from the long-standing history and collective knowledge of the people at Adafruit. This addition to the HAT family of boards is another

variant of its Perma-Proto ecosystem. It's a well-thought-out PCB that allows for easy prototyping of through-hole and surface-mount components.

At first glance, you might think it's just a prototyping board, but it's more than that and very thoughtfully designed. The kit includes the PCB, a 2x20 GPIO header, and a blank 24C32 I²C

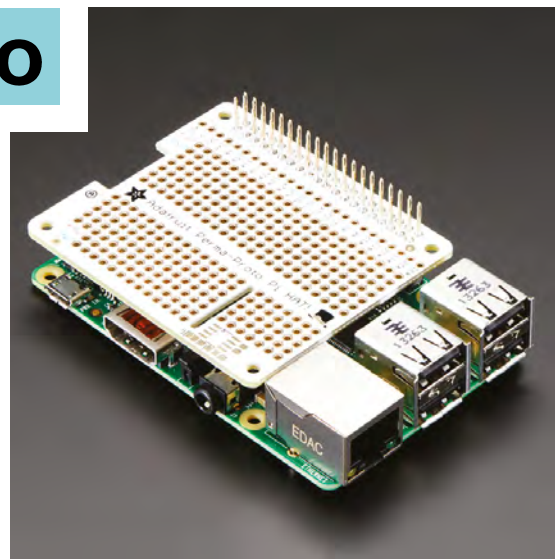

EEPROM soldered on and connected to the EEDAT/EECLK lines, making development of a new HAT for your Raspberry Pi much easier. Customise it how you like and, for this low price, you might want to consider adding a few of them (or the version without the EEPROM) to your hardware stash. □

PiJuice HAT

PIJUICE HAT ◆ \$48 | uk.pi-supply.com

Right ◆

A must-have for any off-grid Raspberry Pi project

VERDICT

If you need uninterrupted power, this is for you.

8/10

There is no arguing that **Raspberry Pi is a great single-board computer, but powering it down can be an issue if not done properly.** Unlike an Arduino,

a Raspberry Pi can get a bit wonky if it loses power. Just like a traditional computer, you need to tell your Raspberry Pi to shut down so its data and operating system won't be corrupted. This makes some projects difficult to manage if they are battery-, wind-, or solar-powered, and that's where the PiJuice HAT really shines.

This is not just a simple battery pack for your Raspberry Pi – it's much more than that. It can also monitor the voltage available and safely power down your Raspberry Pi if the voltage

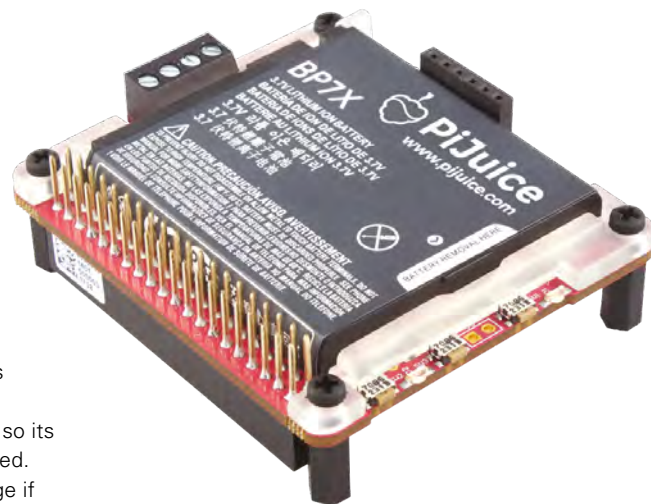

gets too low. It's the perfect solution for any off-grid application. Check out the product page for examples of how to build a remote camera, weather station, game console, and more. □

SparkFun Pi AVR Programmer HAT

SPARKFUN ◆ \$22 | sparkfun.com

The **Pi AVR Programmer HAT was born out of necessity for a product run at SparkFun Electronics.** Fortunately for electronics developers, the firm now offers this robust programmer for sale to the general public. It's

a fast and reliable way to program AVR's at home, saving time and minimising mistakes.

The HAT plugs directly into the GPIO port on your Raspberry Pi and, once configured, you can start programming an AVR by simply pressing the capacitive touchpad. This HAT

Right □
Harness the power of Raspberry Pi to program AVR's

can also be used directly from the command line using AVRDUDE commands with some additional setup, which is all documented on the product page. If you're an AVR developer, this is a good addition to your electronics lab. □



VERDICT

A cost-effective programmer for AVR's.

9/10

BEST OF BREED

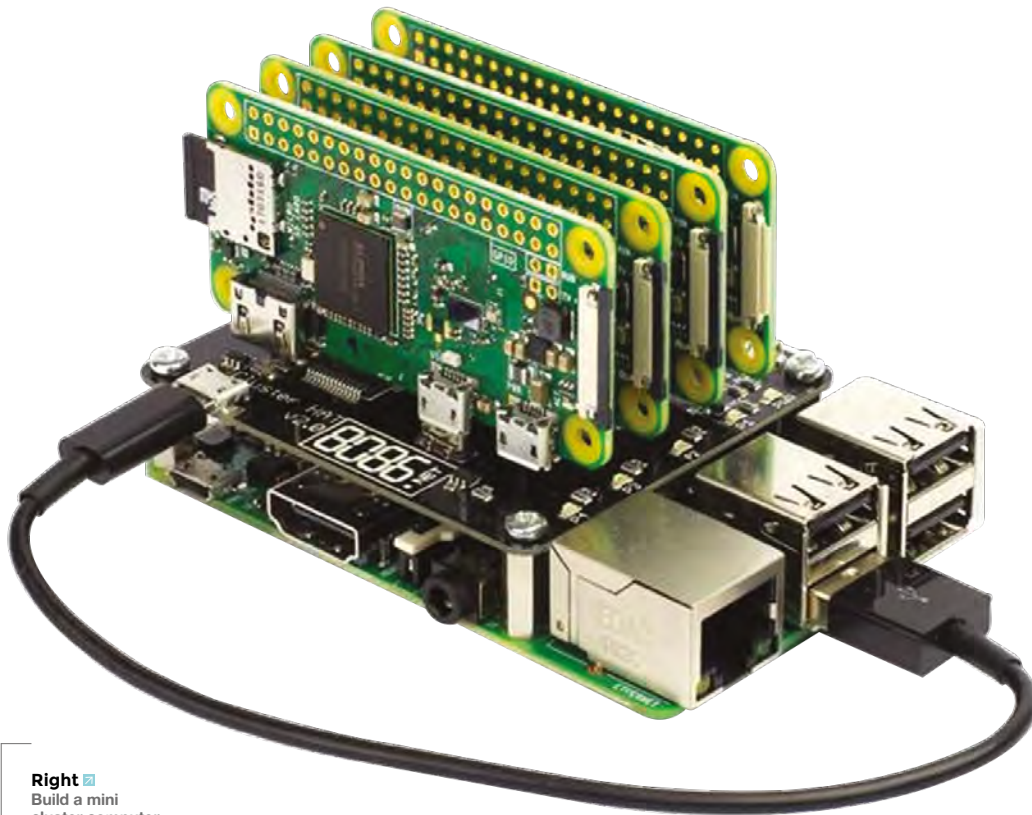

Right  Build a mini cluster computer

Cluster HAT Kit

CLUSTER HAT KIT  \$150 | pishop.us

Building a computing cluster is a daunting task, especially when it comes to working with the Linux kernel in Gadget mode and configuring networks. But, thanks to the Cluster HAT Kit, you can be up and running with a cluster computer in a matter of hours. And yes, I know this is not exactly going to be a high-performance cluster computer solving incredibly complex problems, but that's not the point.

What this product really excels at is allowing anyone to play around with cluster computing

without breaking the bank, and with a great amount of success. Most, if not all, of the principles you learn when building this simple Raspberry Pi kit can be applied to a larger, more powerful, cluster computer network. That being said, it's still pretty powerful and useful, even if it's only four Raspberry Pi Zero Ws.

The kit includes the Cluster HAT, four Raspberry Pi Zero W boards, four SD cards, USB cable, and required standoffs. You will need to supply your own Raspberry Pi as the host computer. If you are interested in this kit, but already have a few Raspberry Pi Zero boards, check out the much less expensive HAT-only version on the site. 

" Cluster computing without breaking the bank, and with a great amount of success **"**

VERDICT

A simple way to make a mini computer cluster.

8/10

£12.99
200 pages of
Raspberry Pi

THE *Official*

RASPBERRY PI PROJECTS BOOK

VOLUME 4

Amazing hacking
& making projects

from the creators of

The MagPi magazine

Inside:

- How to get started coding on Raspberry Pi
- The most inspirational community projects
- Essential tutorials, guides, and ideas
- Expert reviews and buying advice

Available Now

**FREE
DELIVERY**

store.rpiexpress.cc

plus all good newsagents and:

WHSmith **BARNES & NOBLE**

Available on the
 App Store

GET IT ON
 Google Play

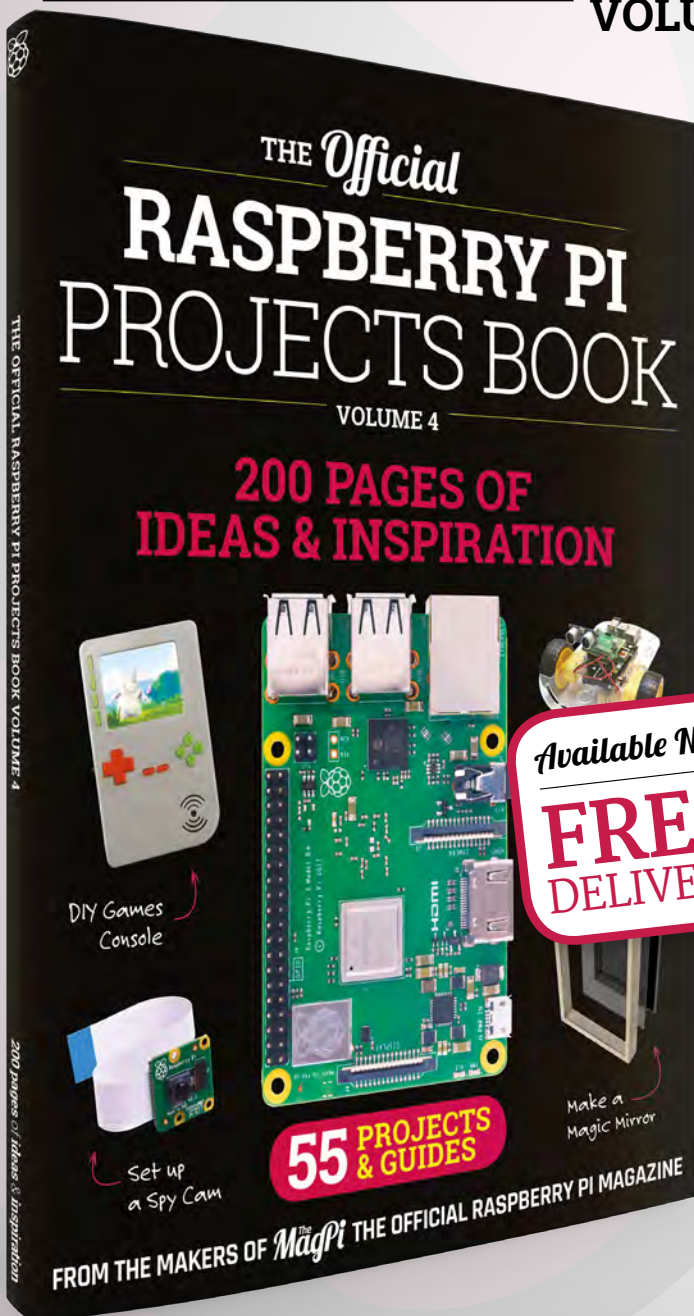

Can I Hack It?

The Force

Can we hack a *Star Wars* toy?



Les Pounder

🐦 @biglesp

Les Pounder loves taking things to pieces and seeing how they work. He teaches others how to be makers and tinkerers at events across the UK. He blogs at bigl.es

YOU'LL NEED

Star Wars Force Link Starter Set

COST

£4-£8

WHERE

hsmag.cc/IJBKdU

Right

🔗 This unassuming toy will unlock your cosplay and transport you to a galaxy far, far away...

The *Star Wars* Force Link toys are a range of 3.75-inch action figures and vehicles that contain an embedded RFID chip, identifying the figure to a wrist-mounted reader. This reader contains all of the sound effects for figures in the range, and a motion sensor chip that can be used to trigger sound effects for battles in space and on the ground. And yes, that does include lightsabers. But how can we elevate this toy into something much grander, say for cosplay? Well, first we need to take it apart and learn how it works! Get your screwdrivers, spudgers, and soldering irons ready!

GENERAL CONSTRUCTION

Held together with cross-head machine screws, the plastic chassis of the wrist-mounted reader is the typical firm, yet workable, plastic common to mass-produced toys. The chassis is hinged to create two pieces: one worn at the wrist, and the other resting on the back of the hand. To secure the reader to the player, a Velcro loop is used. The size of the Velcro loop is for very small wrists.

ELECTRONICS

Oh, this is packed with tech! Inside the reader is an NXP 61002 RFID reader which connects to the main board via a cable. The NXP 61002 can be detached from the board, and it can be used independently as a generic RFID reader with a Raspberry Pi, Arduino, or any other board that has an SPI interface. On the main board, there is a 'blobbed' chip which prevents reading or access. Inside this chip is a basic motion sensor that detects when the wearer moves their arm around. The motion sensor will only trigger sound effects when there is a figure in the player's hand. Coming from that chip are a series of test points which can be soldered to for investigation with the correct equipment. Speaking of test points, there are points for SPI which we used to connect to an Arduino for further hacks!

The electronics also contain a 25Q16CS1G, a flash memory chip which stores the audio files played when a figure is presented to the reader. To power the reader there is a holder for 3 × AAA batteries, giving us 4.5V of power, but the power is regulated by a 3.3V regulator. The battery holder is connected to the circuit board in two places: a single wire

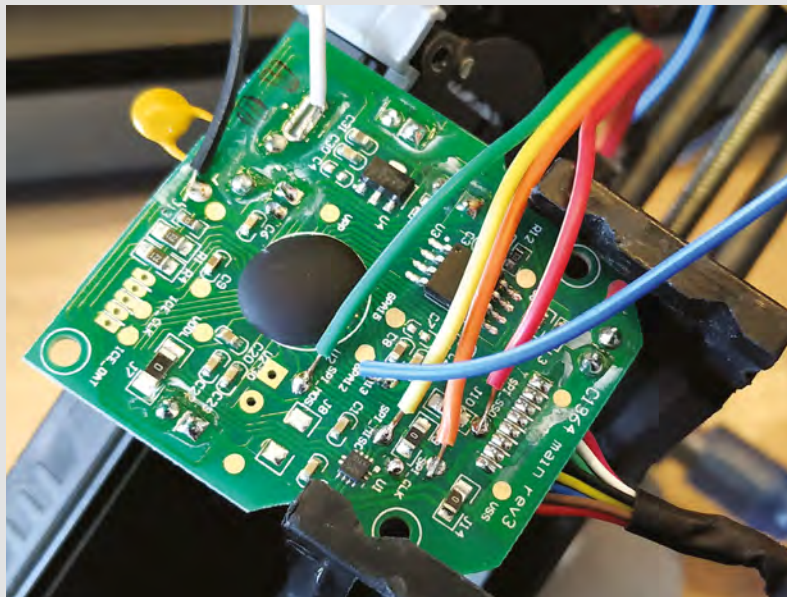

**Above**

On the main board, there are multiple test points which can be used to connect the RFID reader to a board, such as an Arduino, Raspberry Pi, etc.

**Top**

The RFID tags are buried deep inside the figure or vehicle, and require some brutal hacking to remove

Above

The RFID reader is connected to the main board via a group of wires to a removable, and well-documented, connector

connecting the ground (GND, -) terminal, and a much larger mechanical connection for the Vcc (+). This connection can be desoldered with careful application of a desoldering pump and a soldering iron. Once desoldered, we have access to the underside of the board and to the speaker terminals. Desoldering these terminals and connecting an inline amplifier will boost the audio levels of the voice/sound effects.

But what is inside a figure? Well, after performing some rather brutal surgery on Kylo Ren, we found a single RFID tag with only two exposed connections: C1 and C2, with C1 already connected using what appears to be a capacitor. It is possible that by changing from C1 to C2, other functions can be unlocked, and we leave that to curious hackers to investigate.

HACKABILITY

There is plenty to hack here!

We have an RFID reader that is compatible with many devices. All we need is a little time with a soldering iron and access to a compatible device.

For cosplay, we can remove the plastic chassis, prime and paint it to match our cosplay outfit, or we can integrate the electronics. A screwdriver and soldering iron are all we need to pull the electronics out and add it to a Kylo Ren outfit. In fact, with the other figures in the Force Link range, we can add cool sound effects for most characters.

The RFID chip, which is used to trigger the playback of audio, is tiny, but reasonably tricky to

get access to. In fact, we need to destroy the figure to get the chip. But, while this brutal act may rob collectors of a figure, we have access to a simple trigger for cosplay. The chip can be hidden in the fingertip of a glove and requires no power! Just by moving the chip near to the reader, we can trigger audio. Add an amplifier and better speaker, and you can bring a great performance with very little tech.

CONCLUSION

For cosplay and collectors, this is a fun piece of tech to play with and, because it never sold very well, it can be found for bargain prices, including the Dark Lord of the Sith, Darth Vader! Adding this to an existing Vader cosplay would be awesome, and make you the talk of a 'con! □

GETTING STARTED WITH RFID

RFID is awesome, and it is all around us! Access cards for government offices, security tags in shops, and medicine containers in hospitals are all places where we can find an RFID chip. In fact, some people have RFID chips embedded inside their bodies, so they can interact with door-locks by touching the door!

To get started in RFID, you can purchase an RFID-RC522 board from eBay or AliExpress for around £5, and there are many examples of how to use the board on the internet. But, if you would like something a little more curated and simple to follow, then the Clever Card Kit from Monk Makes is great! Retailing for around £15, this kit provides all the equipment needed to use RFID cards with the Raspberry Pi. If you, or the kids, are interested in adding RFID to a project, then this is the kit to start with. Purchase it from UK supplier CPC (part of the Element14 family) via monkmakes.com/cck.

Arduino Every and 33 IoT

The tiniest Arduino board gets an overhaul

By Ben Everard

 @ben_everard

The Nano line of Arduino boards has been a staple of makers for over a decade. They're small and cheap (compared to other official boards), yet still come with the USB connector and all the power of the larger boards.

Technology has moved on since the first version of the Nano came out, and Arduino has released a line of new boards in the Nano form factor – we're taking a look at the Nano Every and the Nano 33 IoT.

The Nano Every is based on the ATmega4809 microcontroller running at 20MHz. This is broadly compatible with other AVR chips from Arduino,

including the one in the original Nano. This board is running at 5V, so should be a completely drop-in replacement for the original Nano, but with more flash (48kB) and more RAM (6kB). At eight euros, this is the cheapest board that Arduino makes by a fairly significant margin.

The Nano 33 IoT also comes in the same form factor as the Nano, but it's built on the 32-bit ARM SAMD21G18A microcontroller. It runs at up to 48MHz and has 256kB of flash and 32kB of RAM. Overall, this is a significantly more powerful processor than the AVR chip in the Nano Every. As well as this, there's an ESP32-based u-blox module for WiFi and Bluetooth, and a six-axis inertial measurement unit. All this comes in at 16 euros, which is twice the cost of the Nano Every, but it's still one of the cheapest boards that Arduino produces.

Both of these devices are tiny, solidly made, and as easy to use as you'd expect from devices made by Arduino. Unlike many small boards, there are four mounting holes, so you can easily secure the board in your projects.

They're completely flat on the bottom, and have castellated pads so they can be soldered onto other PCBs to make a sort of permanent shield setup – a sign that Arduino is targeting the small-run electronics industry by making it easier to build products out of Arduino projects.

POWER SUPPLY

The world of small microcontrollers is pretty crowded at the moment, but these new Nanos do have their niche within it. They're among the smallest boards around, yet still pack in quite a healthy amount of IO (12 digital, 8 analogue in, and 1 analogue out). They achieve this feat by cutting out one key feature found in most slightly larger

Below ♦
The new Nanos are tiny, but the 33 IoT is very slightly larger

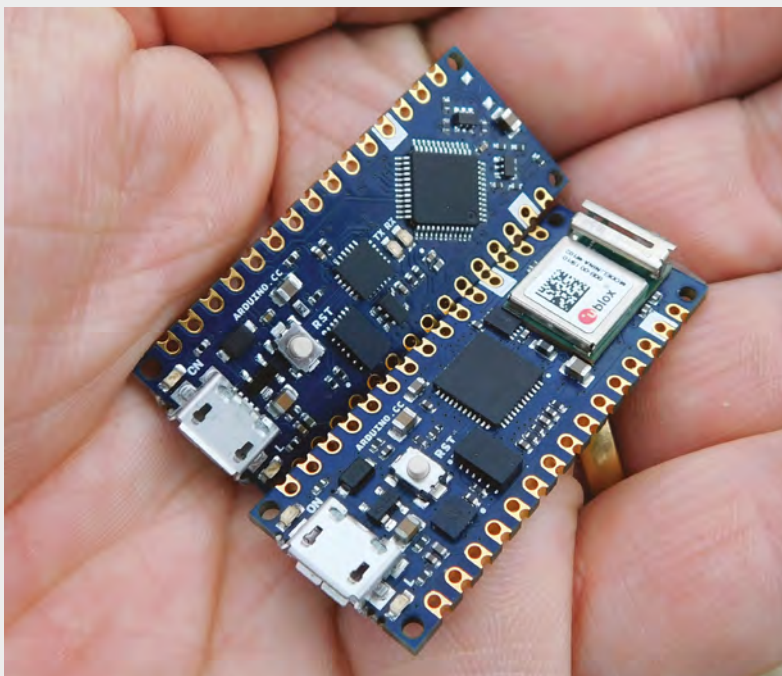

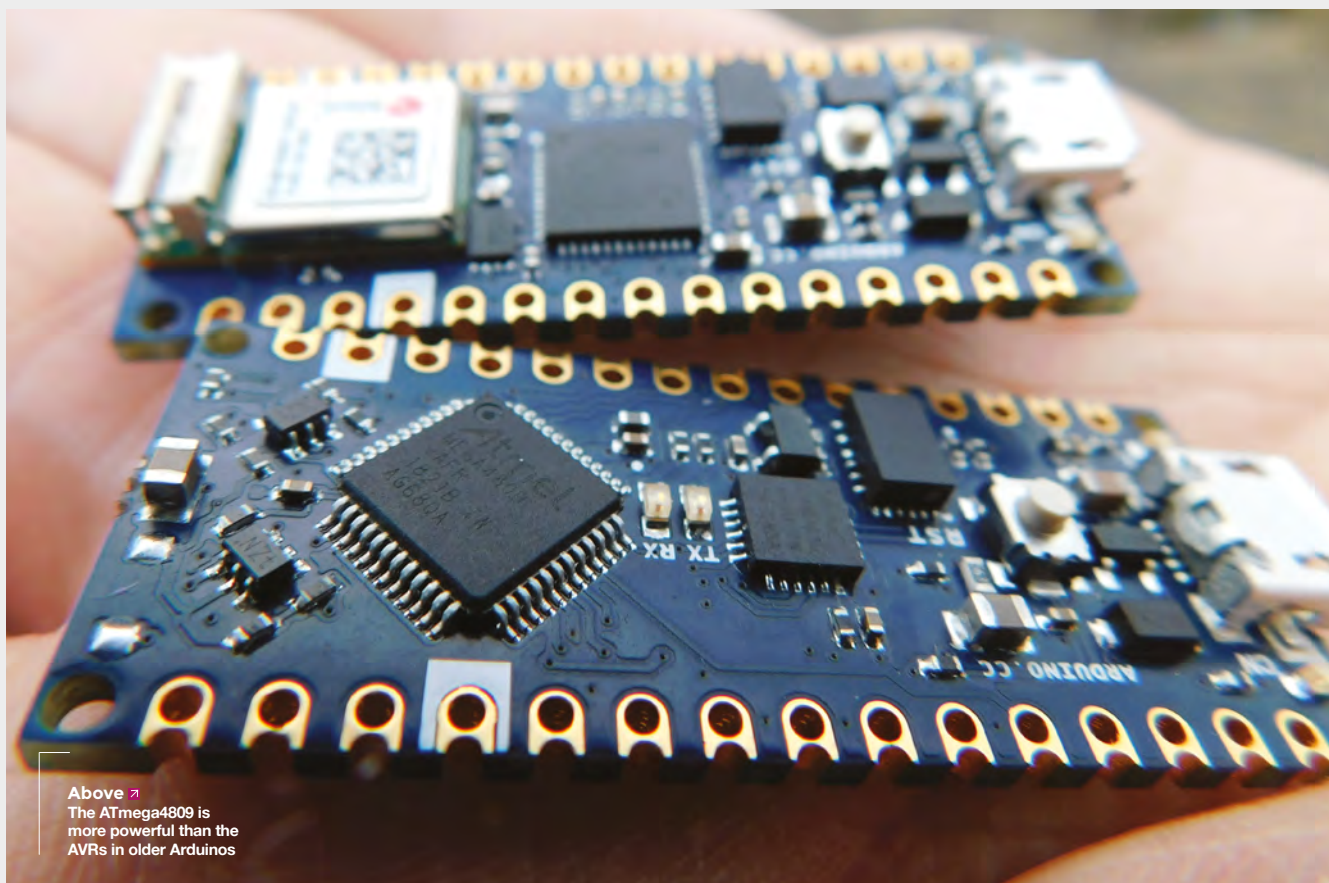

Above ↗
The ATmega4809 is
more powerful than the
AVRs in older Arduinos

boards – battery management. You’ll need a source of power, whether via the USB port or up to 21 V via Vin. The rather beefy on-board regulator can provide up to 950mA for peripherals.

In a world of 3V microcontrollers, the Arduino Nano Every is probably one of the best choices for 5V microcontroller right now from a price to performance ratio, as long as you don’t need battery charging or networking. There is less 5V hardware around these days, but if you find yourself needing to control some, this will save you the hassle of level shifting. With 950 mA of current available from the regulator, and 5V IO, this is a great choice for small to medium-sized NeoPixel projects.

The Nano 33 IoT is in the fuller marketplace of 3.3V WiFi-enabled development boards, but it does have a few stand-out features. It’s the smallest, cheapest board that’s compatible with the Arduino IoT Cloud. While this online development environment is still in development, it’s shaping up to be a really easy way to get started with IoT devices. The Nano 33 IoT has the sprightly performance that we’ve come to expect of boards based on the SAMD21 microprocessor, and the off-chip WiFi gives solid networking performance. □

BENCHMARKS

Overall, the 33 IoT is about four times the speed of the plain Nano Every. The only exception to this is in floating-point multiply and divide. Each test is running a million instances of each instruction, except the analogue input which is only 10,000. The result is the number of milliseconds that the process took to run.

Benchmark	Nano 33 IoT performance	Nano Every performance
Analogue input	4,234	1,124
Integer sum	147	884
Integer multiply	211	829
Float sum	2,609	8,560
Float multiply	14,757	12,684
Float divide	32,485	46,542
GPIO test	3,303	72,722

VERDICT

Arduino
Nano Every

If you need a small, 5V microcontroller board, this has to be top of your list.

9/10

VERDICT

Arduino Nano
33 IoT

A no-nonsense WiFi microcontroller that fits in the tiniest of spaces.

8/10

Korg Nutube OD-K1

Vintage sounds at a fraction of the voltage

KORG ♦ £126.31 | hsmag.cc/yhkFQs

By Andrew Gregory

[@AndrewGregory83](https://twitter.com/AndrewGregory83)

Every guitar geek knows that the best sound comes from valves. Lovely, archaic, inefficient, glowing expensive valves. When transistors, and later op-amps, became available to pedal and amplifier builders, one of the advantages was cost. That's still a factor today: transistors cost pennies, while valves cost many times more, are fiddly, will eventually wear out, and need mains voltage to amplify a signal from your guitar cable. If only there were a way to combine the best bits of both? That's the premise of the Korg Nutube, packaged here as part of a distortion pedal kit, distributed in the UK by RS Components.

Korg claims that these things give all the benefits of valve tone, with the added bonus of being smaller, more reliable, and less dependent on mains electricity.

Below ♦

Unbranded aluminium boxes like this are either very rubbish or very good – this is excellent

Right ♦

The Nutube (bottom-right in the pic) glows with blue light as the guitar signal goes through it



To understand how they work, we need to look at how valves work. A tetrode valve has a cathode, an anode, and an electron grid. The cathode is a source of electrons that are accelerated toward the anode (also known as the plate). Where electrons move over the grid is where the magic happens: small changes in voltage at the grid, relative to the cathode, cause electrons to be either attracted or blocked at the grid, causing a proportionately higher or lower voltage at the cathode. The components are sealed in a vacuum in a glass tube, hence the American name, vacuum tubes.

Transistors work in a similar way: the base, collector, and emitter are analogous to the anode, grid, and cathode of a valve, but a transistor works by amplifying current, not voltage, so some of the characteristics of valve amps are lost.

That's where the Nutube comes in. It uses very similar technology to cathode tubes: vacuum fluorescent display, which also uses the same anode, grid, cathode system – in this case, to make a filament glow as part of (most usually) a seven-segment display. They're common in tech from the early 1990s. The versions used in the Nutube glow as voltage is passed over them, and they also produce signal gain, which Korg has put to good use in a range of products for the electric guitar.



THE KIT

What you get for your money is two PCBs; one for the Nutube, and a larger one for the rest of the through-hole components. You also get the enclosure, pre-drilled, all the components, and the knobs and switches to make it work. It took us two afternoons to put together – if you're better at identifying resistors' bands than us, you'll be able to get it done more quickly.

THE PEDAL

From left to right, the controls are: volume, tone, shape, and gain. In common with a lot of boutique pedals, with the gain turned all the way down, the pedal produces no sound at all, not even a clean tone. There's no arbitrary cut-off where a designer has chosen what the appropriate level of clean is for you – it's up to you to experiment. Turned up to 1 or 2, with the volume at about 5 or 6, and you get a clean tone that goes from dark to bright to cutting, depending on what you do with the tone knob. It brightened up the neck pickup on our Les Paul copy, and rolled off the ear-bleeding shrillness of a Strat played through the bridge pickup. Happy days.

Judicious application of the gain and tone together takes us from slightly gritty, to fuzzy, Orange-like, blunt force distortion and almost, but not quite, up to high-gain metal-type distortion. We're also happy to report that the level of distortion varies according to how hard you hit the strings, just like valve distortion.

Apart from the greater harmonics in valve distortion compared with solid-state circuits, valves also impart a compressed, squashy quality to the sound. You can hear this in loads of old recordings, but REM's *Monster* album and *Seether* by Veruca Salt are good examples. This is what's affected by the shape knob and the trim pot mounted on the PCB. With the trim pot set to half-way, the shape control gives you a way to tighten the distortion on the bottom end. It's great for choppy, percussive clean sounds, à la Nile Rodgers, and it genuinely does give you an authentic valve-like playing feel. Tune the trim pot all the way up and the sound kicks in about a quarter of a second after you hit the strings, which is a bit useless, but fun. And, as with the volume and gain, we like being in control.

NUTUBES

Purists will turn up their noses, but that's an iron law that Korg must be aware of. This isn't for purists: it's for tinkerers who want to mess about with building their own valve-powered effects, amps, and synths



|| This isn't for purists: it's for tinkerers who want to mess about with building their own valve-powered effects, amps, and synths ||

and who want to be able to power them from a battery. The pinout from the Nutube is the same as from a pair of triode valves such as 12AX7s (probably the most commonly used amp valve), so once you've got a working circuit for one, you can work with the other.

Compared with what goes into the average distortion pedal, this is an expensive kit. We see this more as a gateway for home tinkerers who want a valve sound without having to take the risks associated with mains electricity. Home-brew enthusiasts have already made amps using Nutubes, and Vox has brought out a range of Nutube-powered amps starting at £219, which looks like cracking value compared with £126 for this pedal.

There's a load of smoke and mirrors in guitar land, and we've seen tricks such as fake valves lit up with LEDs to simulate the glow of hot electrons. This is no trick, and it's not a gimmick either: it works, it sounds great, and it's incredibly versatile, especially when you get your head around the shape control. Super stuff. □

Above ♦
A 9V battery should last 30 hours – or there's a socket for a mains adapter

VERDICT

A great use for a new old idea.

8/10

CircuitPython 4.1.0

A fast snake that's got something to be scared of

ADAFRUIT  Free | circuitpython.org

By Ben Everard

 @ben_everard



The big feature of CircuitPython 4.1 is the speed. You can see the box below for more information on the benchmarks we ran but, in short, the new version is quite a bit quicker.

Basic operations, such as floating point and integer arithmetic, were about twice as fast, and it was particularly interesting to see that this performance improvement filtered all the way through to the devices controlled by the board. We were able

to flash NeoPixels at twice the rate using this firmware – we're particularly pleased to see this, as we've run into performance issues running NeoPixel matrixes with CircuitPython in the past. There are also big performance gains when controlling screens.

While the software has been moving along, so too has hardware support, and there's now a greater range of supported hardware than ever before. At the time of writing, there were 62 separate devices on the circuitpython.org downloads page, so there's a great

selection to choose from, if you want to get developing with this language.

Ultimately, CircuitPython is never going to match the speed of a compiled language. The overheads of running an interpreter on a microcontroller are just too great. However, most of the time, we're using microcontrollers that are more powerful than we need, and these machines spend a significant proportion of their time waiting for things to happen. Our code, then, just needs to be 'fast enough'.

Earlier versions of CircuitPython were fast enough for some tasks, but it was quite common to hit issues – particularly when working with outputs such as LEDs and screens. This new version means that there are even more areas that you can work with using CircuitPython. 

Above  The CircuitPython mascot is a friendly purple snake known as Blinka

BENCHMARKS

We ran the same tests on a Circuit Playground Express, using both CircuitPython 4.0.1 and 4.1.0. The results are below (lower is better).

Benchmark	CircuitPython 4.0	CircuitPython 4.1
Filesystem write	3.0	3.0
Floating point	26.7	12.2
Integer	30.7	17.3
NeoPixel	20.3	11.7
GPIO	23.5	9.21

VERDICT

Instantly double the speed of your microcontrollers? Yes please!

10/10

The Art of Fermentation

Sandor Katz ◆ \$39.95 | wildfermentation.com

By Ben Everard

 @ben_everard

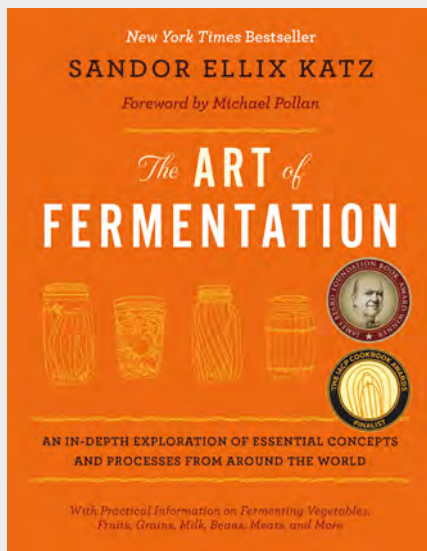

Fermenting is the process of using microscopic bacteria and fungi to change the chemical makeup of something – typically food. If it were invented today, it would no-doubt be called biohacking, and Silicon Valley investors would be throwing huge amounts of money into it. However, it was invented thousands of years ago, and predates not only the notion of venture capitalism, but the idea of money itself.

Sandor Katz is one of the most respected authorities on home fermentation, and in *The Art of Fermentation*, he goes through different types of ferments from around the world, looking at the science, process of performing them safely, their cultural importance, and the culinary applications.

This tome gives you all the knowledge you need to start experimenting with fermenting. You may choose to start with famous ferments such as bread and alcohol, but you could go a bit more off-piste. Perhaps the most fascinating thing about this book for us is how it brings together a huge number of different traditional ferments from all over the world. Every continent, bar Antarctica, is represented by a wide variety of foods. This is important, not just because it gives you options to choose from, but because it gives you lots of knowledge that you can blend together to make your own ferments. Ancient peoples all over the world faced the same (or similar) problems when developing ferments, but they solved them in different ways, and this influenced the directions they took their ferments. By looking now at the different traditions, you can see which techniques work best for your circumstances.

If you only get one book about fermentation (and you really should get one, it's a great way of creating flavour), this is the book to get. □

VERDICT

The bible of fermenting.

10/10

next month

issue

#22

ON SALE
22 AUGUST

MUSIC



Automate your instruments

ALSO

- CIRCUITPYTHON
- LASER CUTTING
- ARDUINO
- METALWORK
- AND MUCH MORE

DON'T MISS OUT

hsmag.cc/subscribe

2500% speed-up

The Raspberry Pi 4 performs the Speedometer 2 browser benchmark 25 times faster than the original Raspberry Pi launched in 2012.

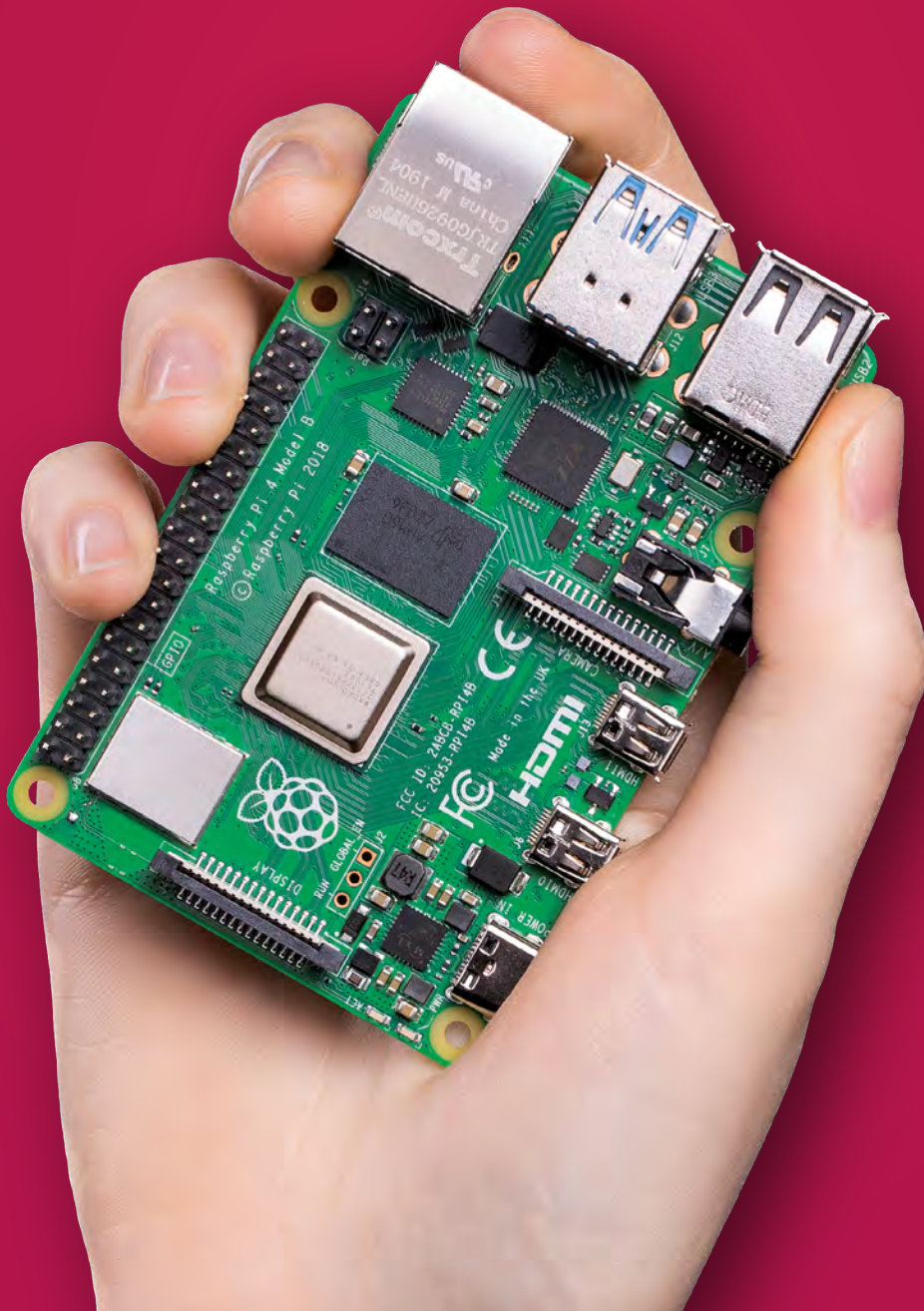



BELIEVE IN IMPOSSIBLE

R A S P B E R R Y P i 4

Faster, stronger, and with more possibilities than ever before, this is the Raspberry Pi 4.
Advanced connectivity, flexible RAM options, and a 1.5GHz quad-core ARM Cortex-A72 CPU.
Find your Raspberry Pi 4 and all the accessories at OKdo.com

